

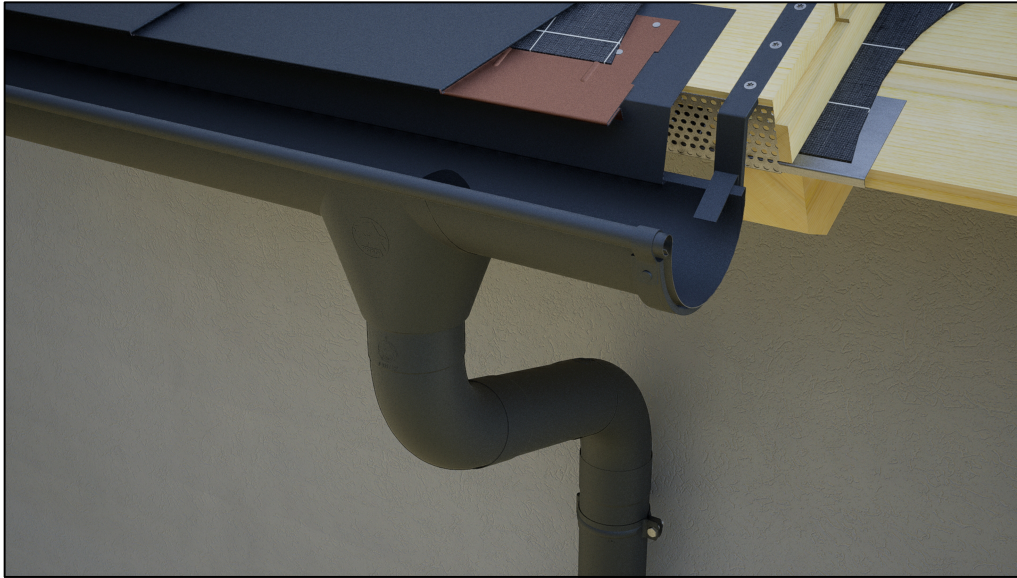

STARK WIE EIN STIER

# ABLAUFROHR ENTWÄSSERUNG CAD-DETAILS



## INHALT:

- 2 Rohrbogen Ø 60
- 3 Rohrbogen Ø 80
- 4 Rohrbogen Ø 100
- 5 Rohrbogen Ø 120
- 6 Sockelknie
- 7 Wasserfangkasten
- 8 Speiereinmündung Ø 80 mm
- 9 Speiereinmündung Ø 100 mm
- 10 Speiereinmündung Ø 120 mm
- 11 Rohreinmündung 80
- 12 Rohreinmündung 100
- 13 Rohreinmündung 120



STARK WIE EIN STIER

# ROHRBOGEN Ø 60

## ENTWÄSSERUNG

### CAD-DETAILS

Rohrbogen 85° Ø 60

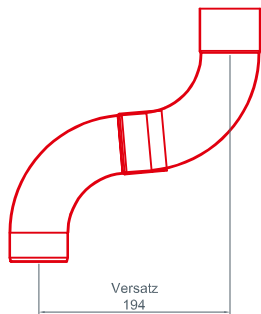
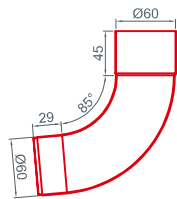

Rohrbogen 72° Ø 60

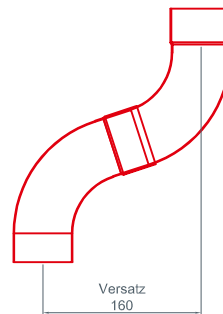
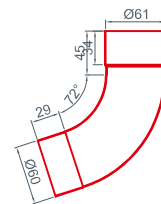

Rohrbogen 40° Ø 60

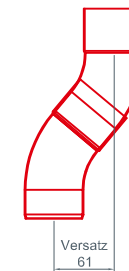



STARK WIE EIN STIER

# ROHRBOGEN Ø 80

## ENTWÄSSERUNG

### CAD-DETAILS

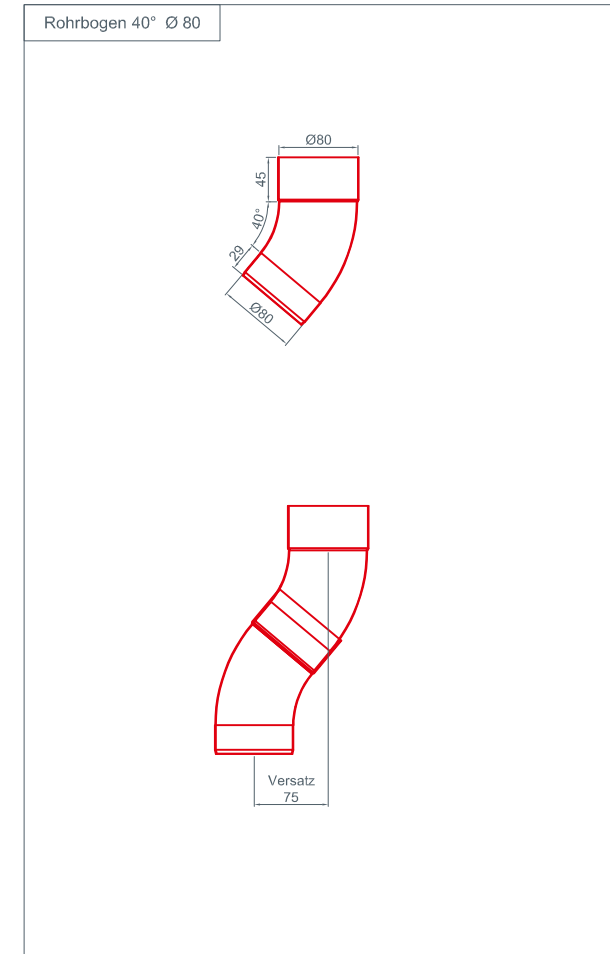
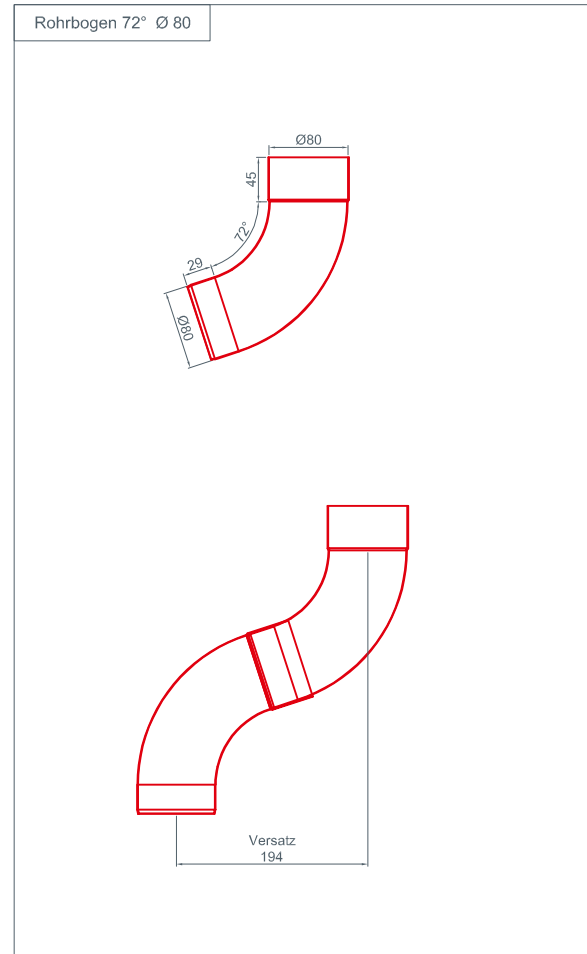
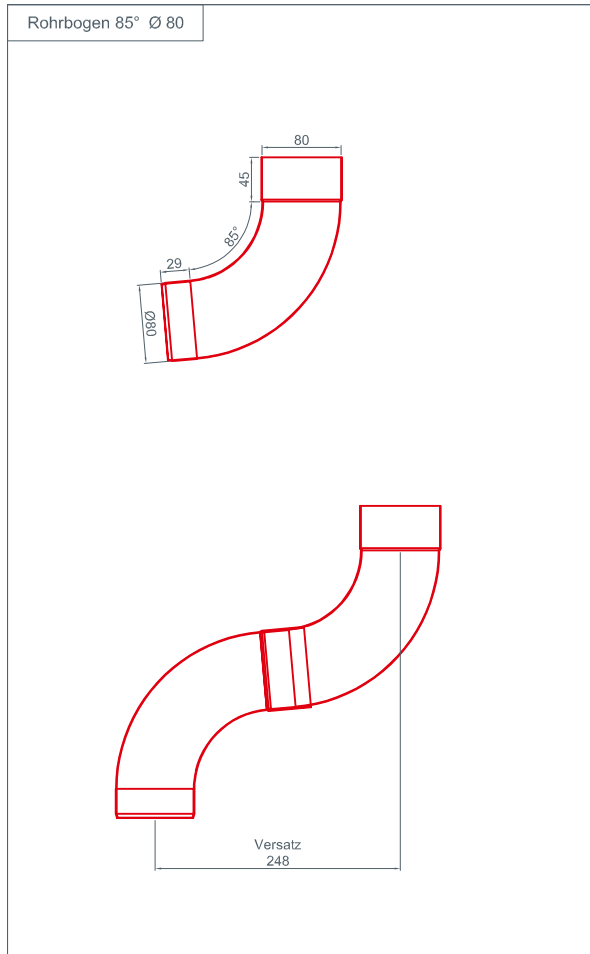



STARK WIE EIN STIER

# ROHRBOGEN Ø 100

## ENTWÄSSERUNG

### CAD-DETAILS

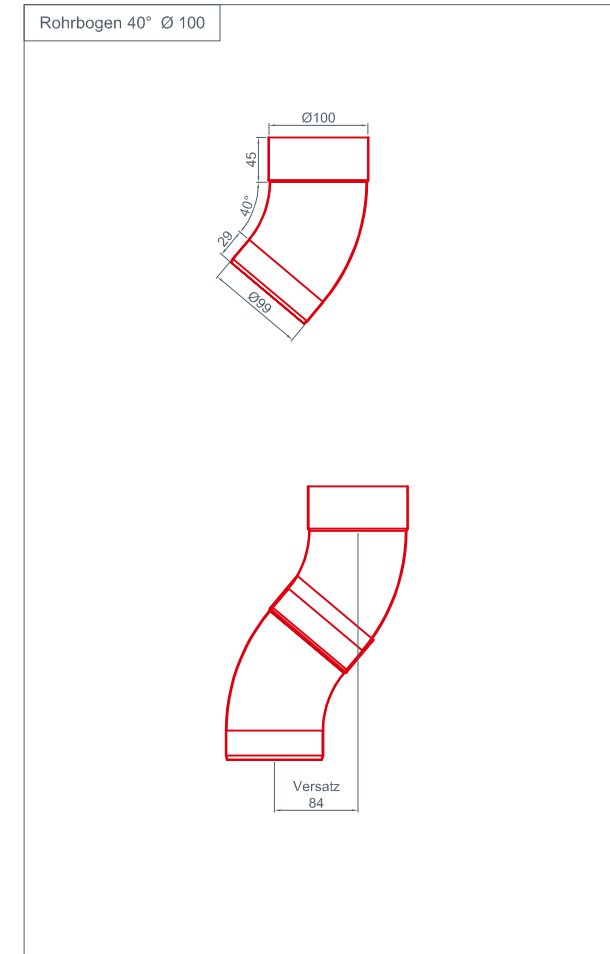
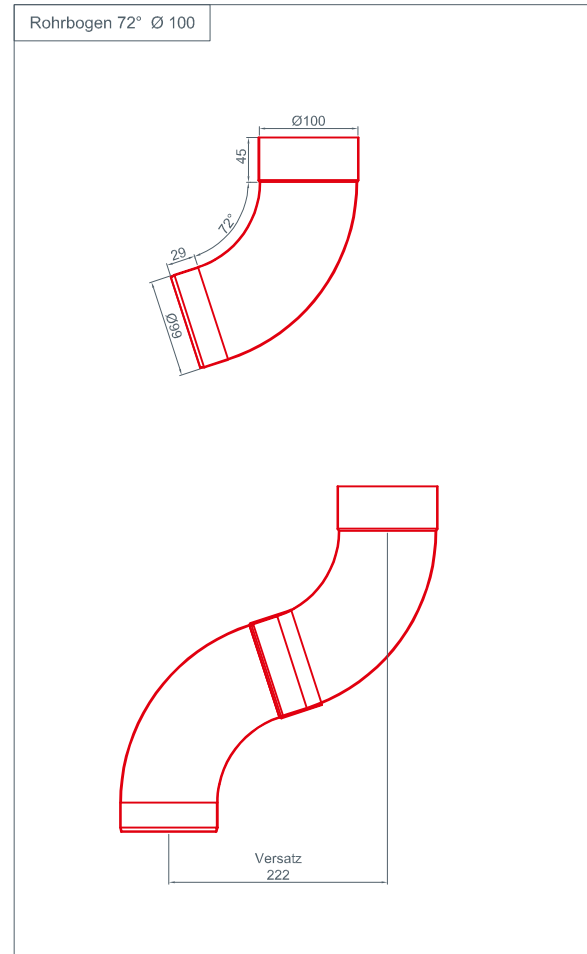
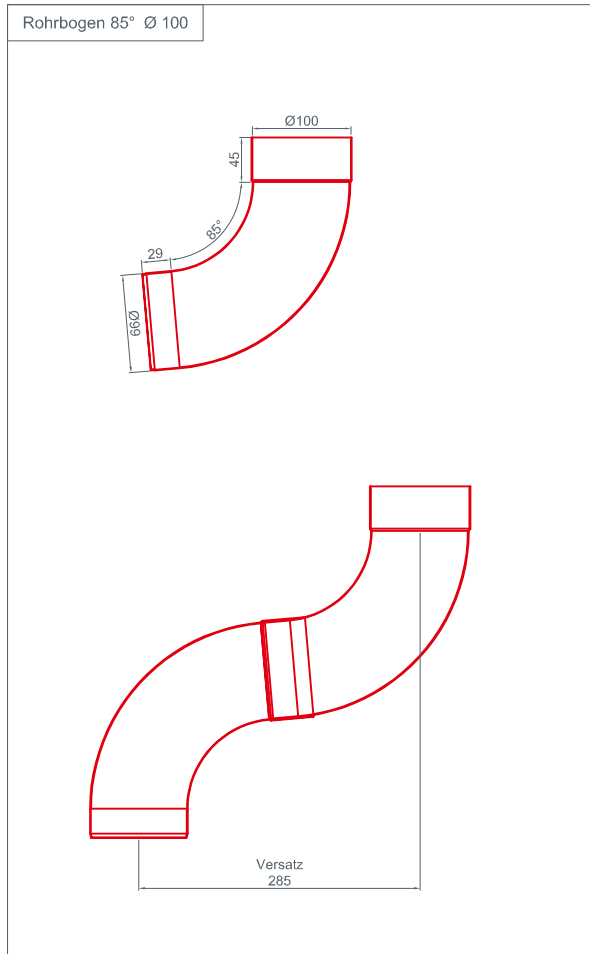





STARK WIE EIN STIER

# ROHRBOGEN Ø 120 ENTWÄSSERUNG CAD-DETAILS

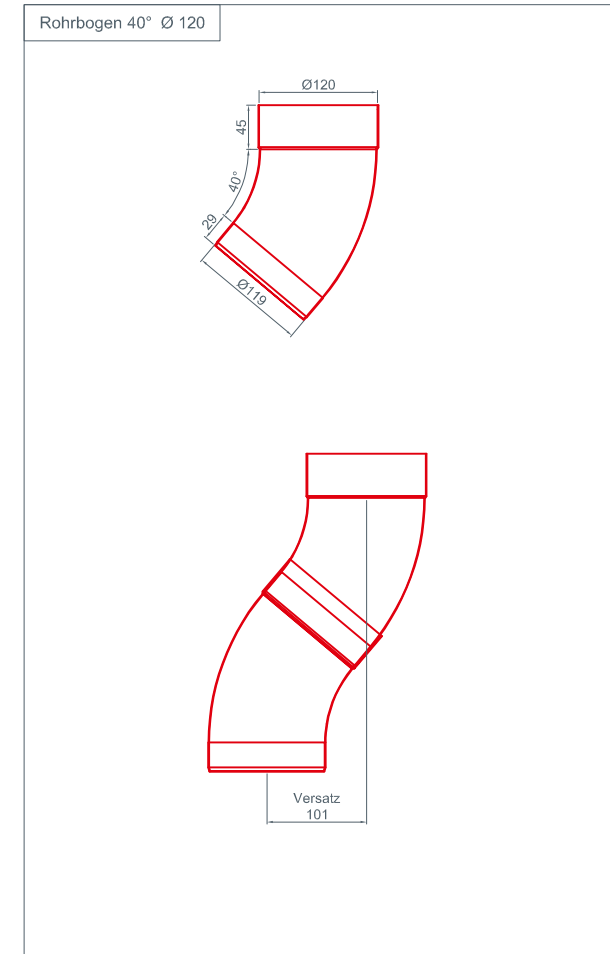
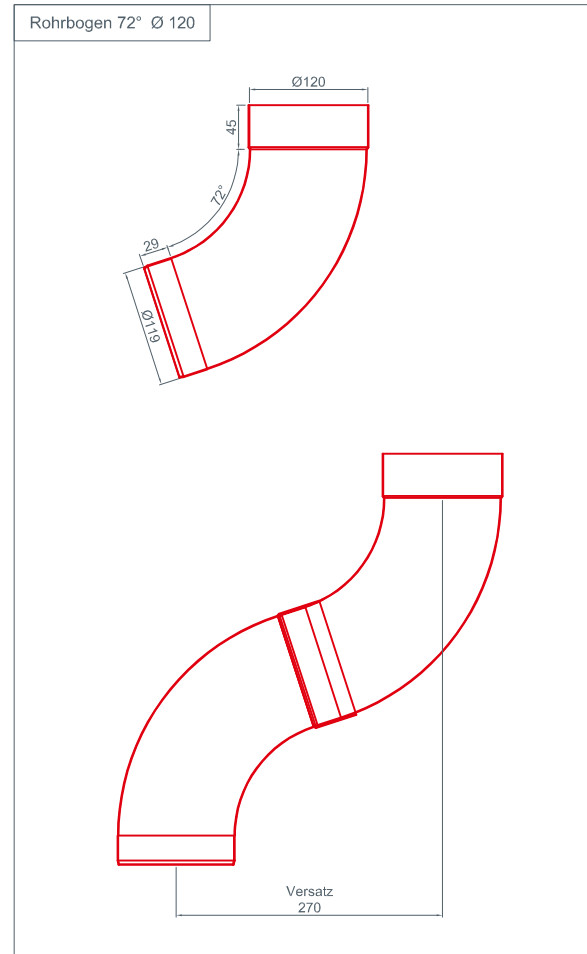
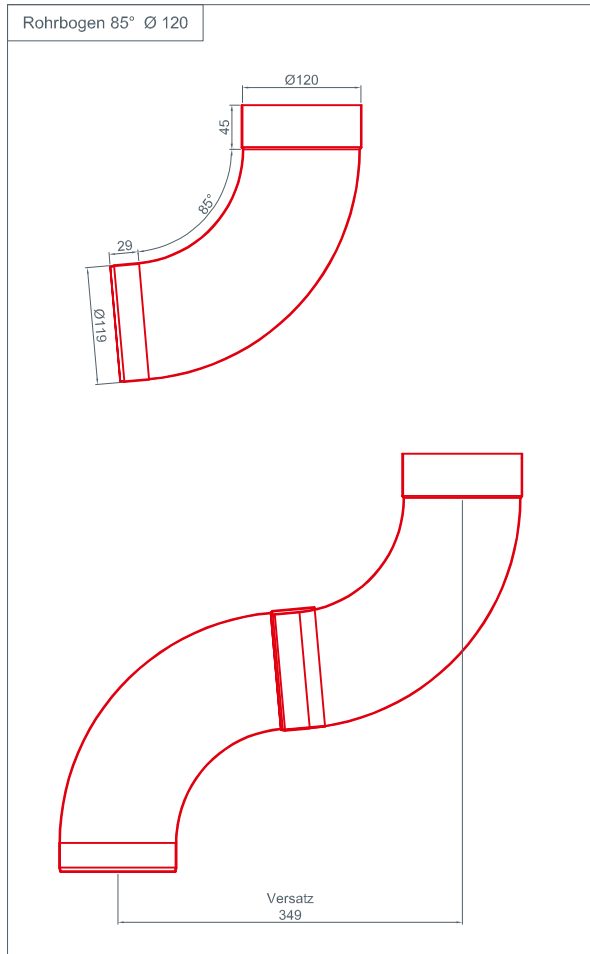



STARK WIE EIN STIER

# SOCKELKNIIE ENTWÄSSERUNG CAD-DETAILS

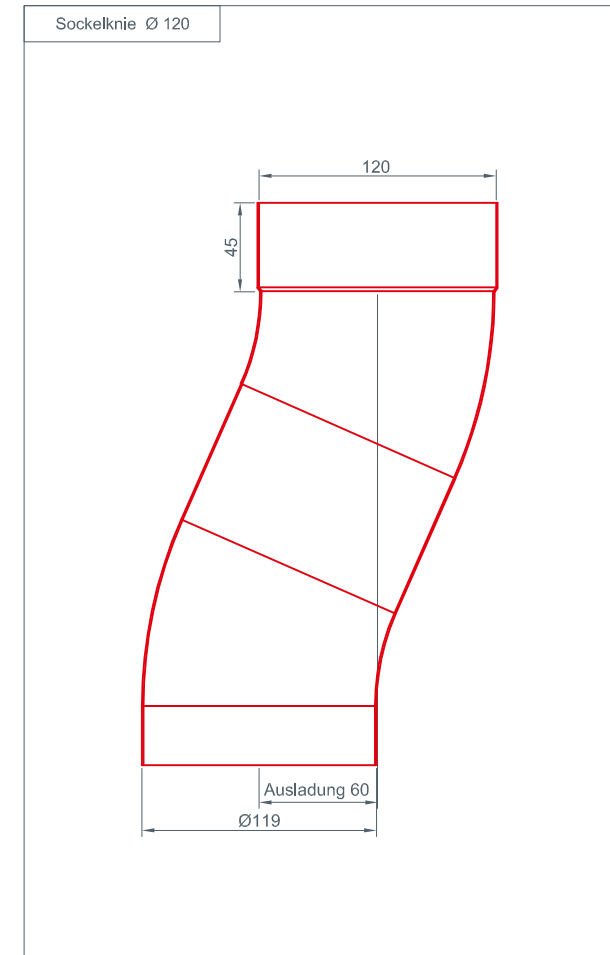
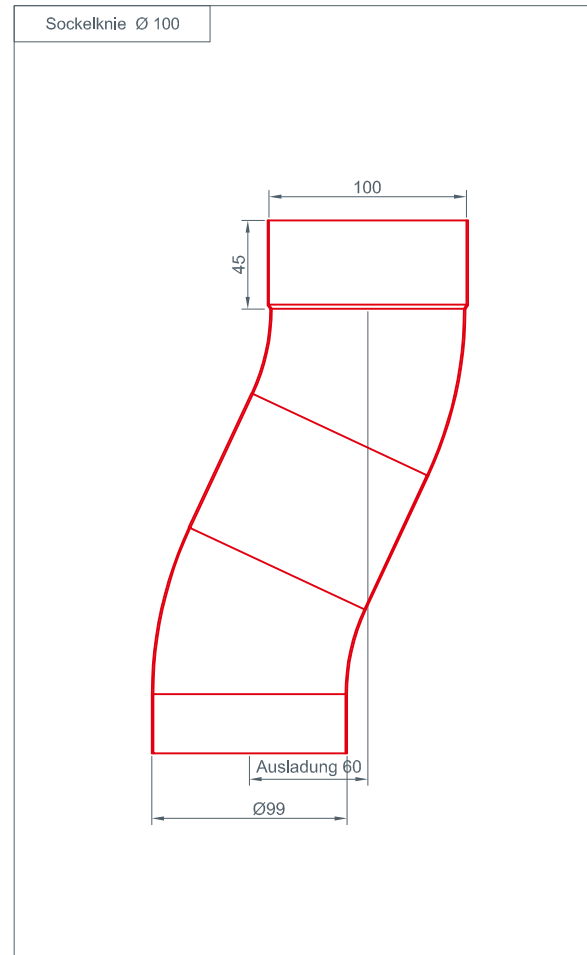
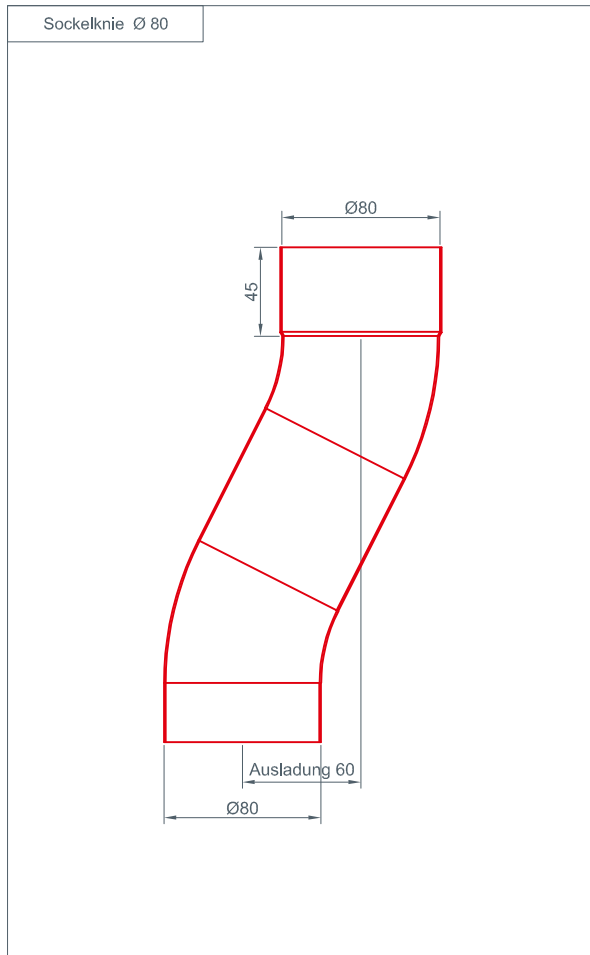



STARK WIE EIN STIER

# WASSERFANGKASTEN ENTWÄSSERUNG CAD-DETAILS

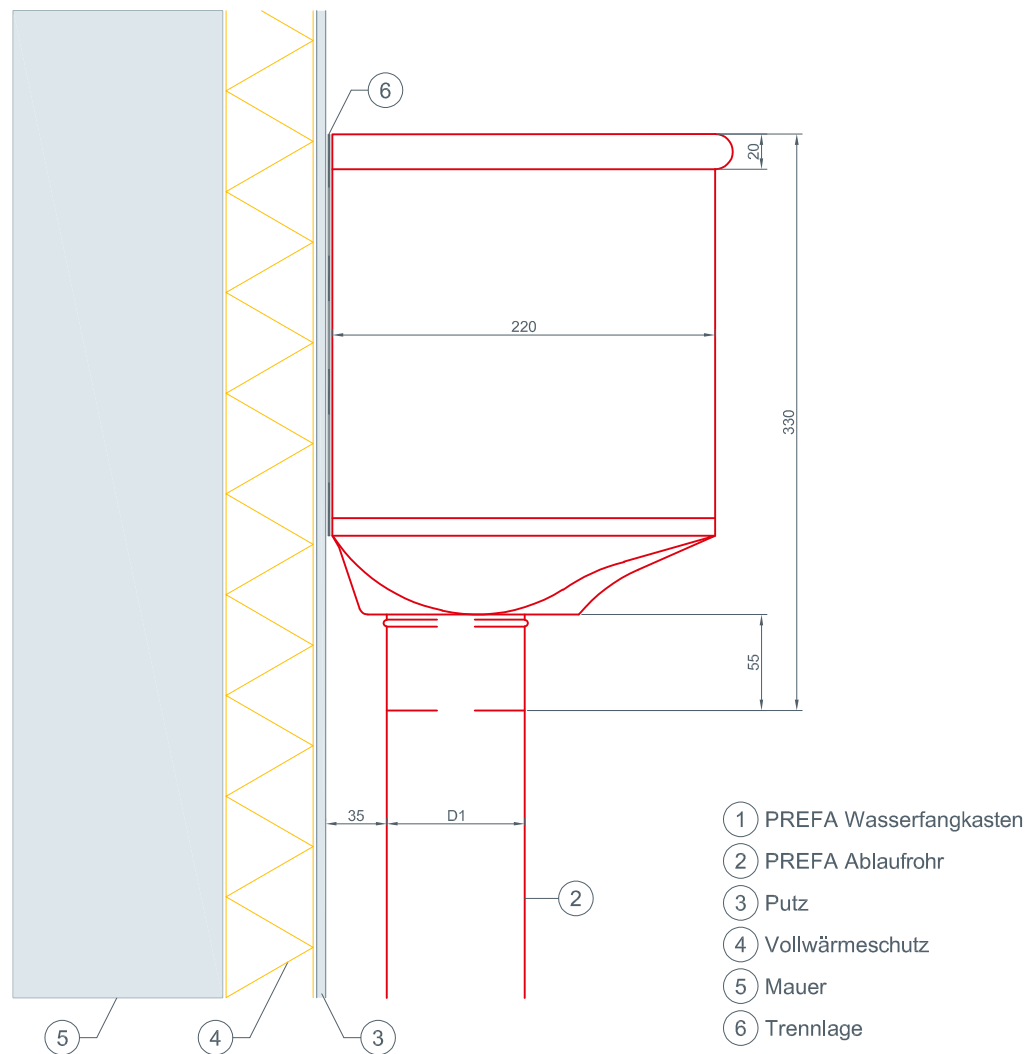

mögliche Ablaufdimensionen D1:

- Ø 80 mm
- Ø 100 mm
- Ø 120 mm



STARK WIE EIN STIER

# SPEIEREINMÜNDUNG $\varnothing$ 80 mm

## ENTWÄSSERUNG

### CAD-DETAILS

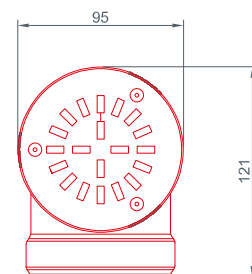
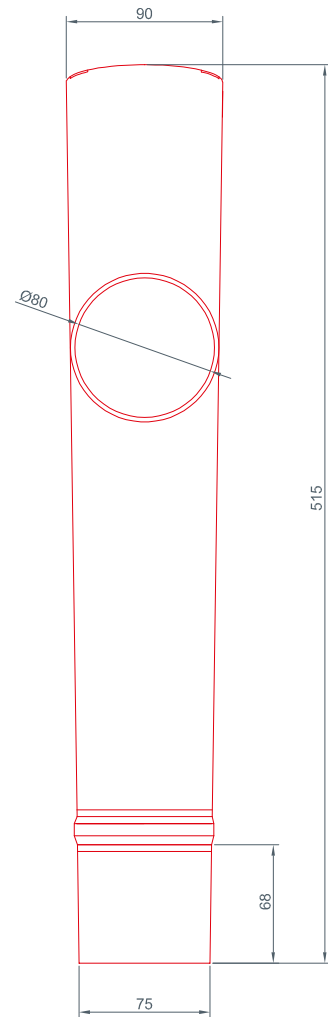
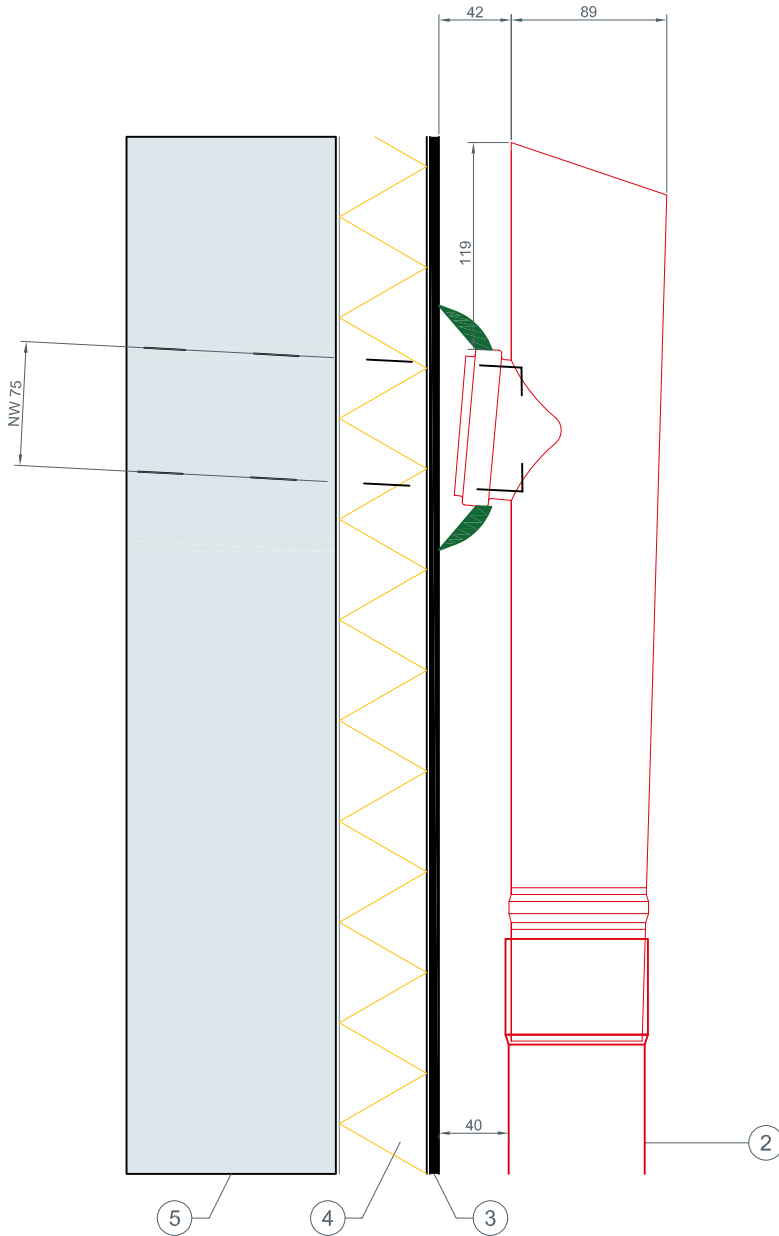

- ① PREFA Speiereinmündung
- ② PREFA Ablaufrohr
- ③ Putz
- ④ Vollwärmeschutz
- ⑤ Mauer
- ⑥ EPDM Dichtung



STARK WIE EIN STIER

# SPEIEREINMÜNDUNG $\varnothing$ 100 mm

## ENTWÄSSERUNG

### CAD-DETAILS

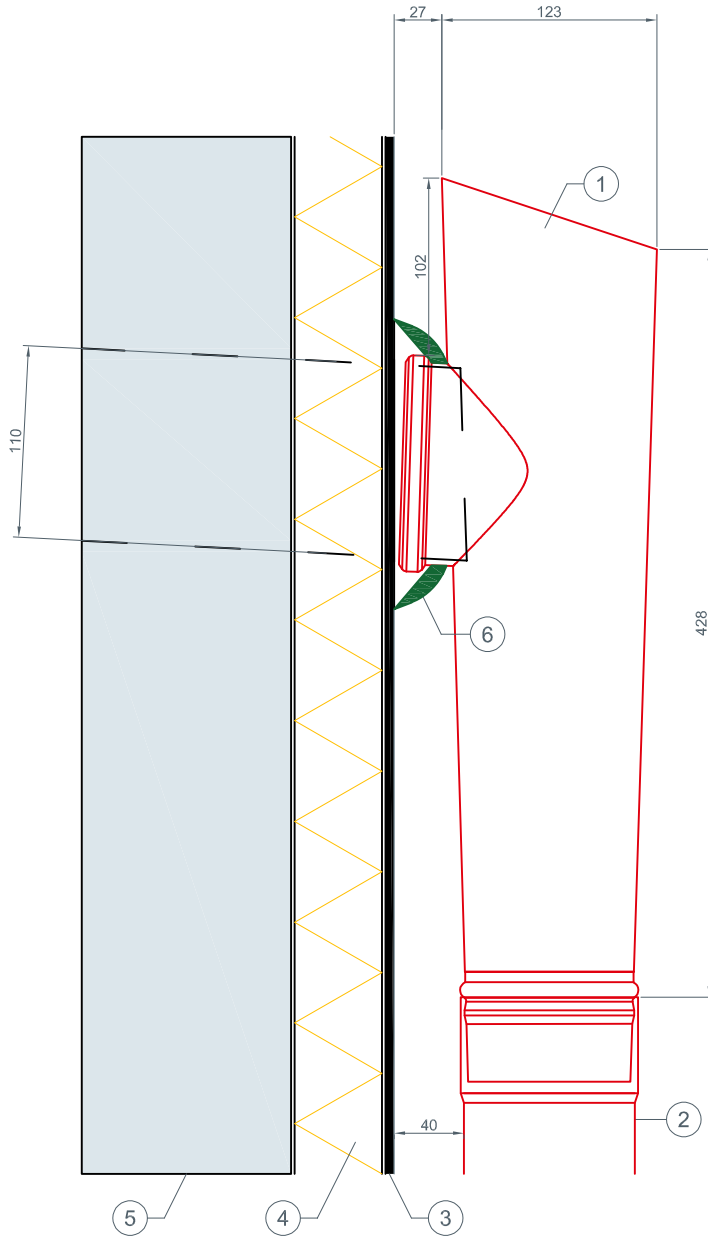

- ① PREFA Speiereinmündung
- ② PREFA Ablaufrohr
- ③ Putz
- ④ Vollwärmeschutz
- ⑤ Mauer
- ⑥ EPDM Dichtung



STARK WIE EIN STIER

# SPEIEREINMÜNDUNG $\varnothing$ 120 mm

## ENTWÄSSERUNG

### CAD-DETAILS

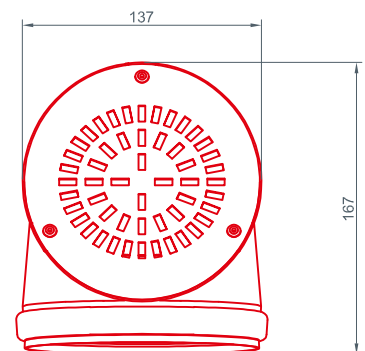
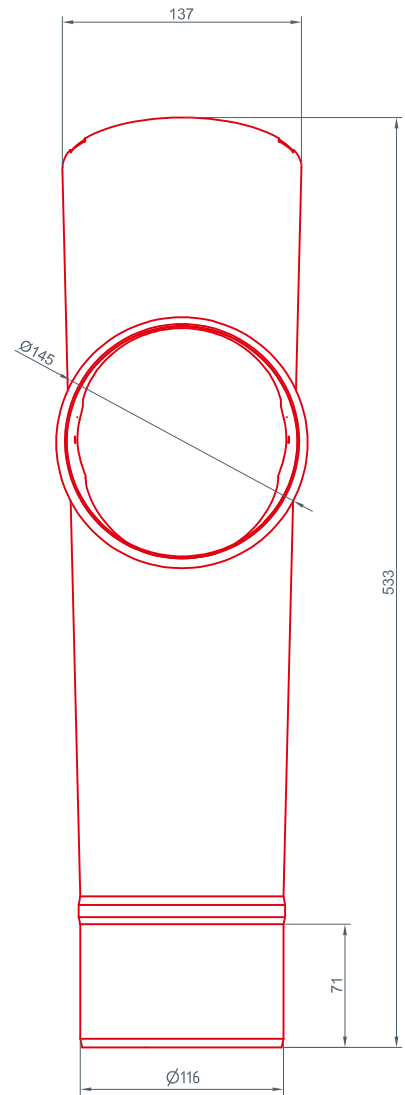
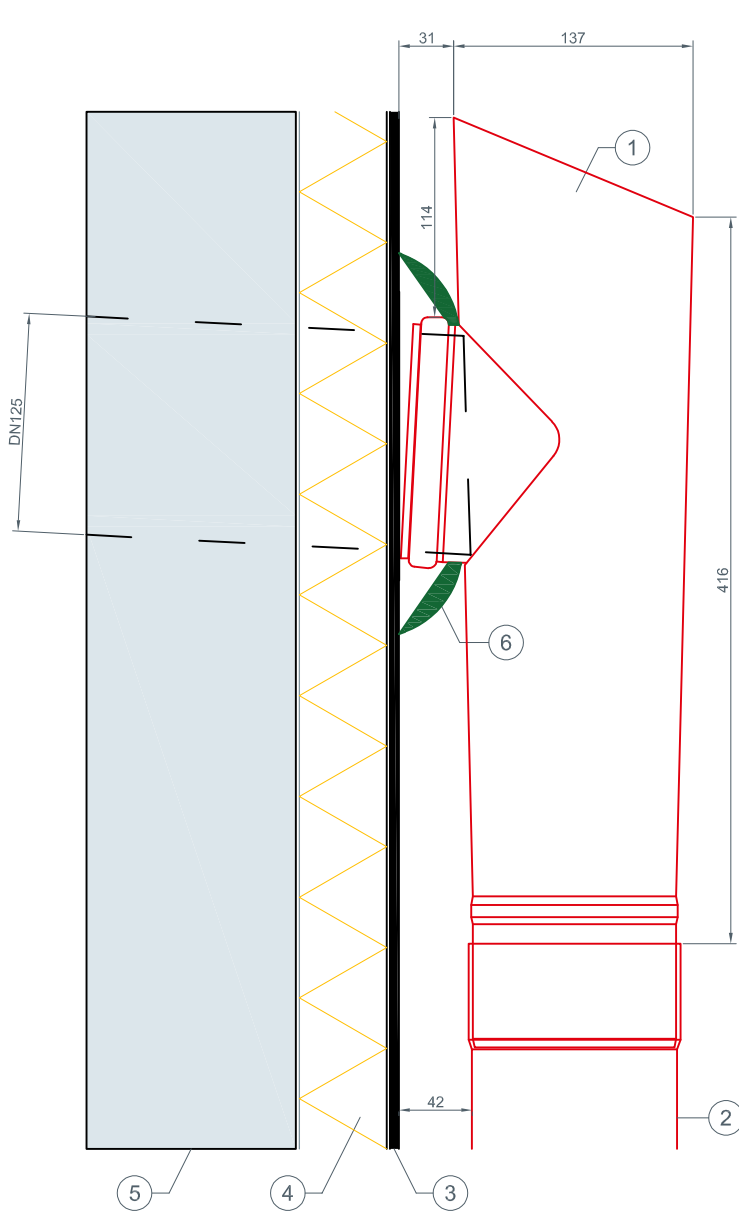

- ① PREFA Speiereinmündung
- ② PREFA Ablaufrohr
- ③ Putz
- ④ Vollwärmeschutz
- ⑤ Mauer
- ⑥ EPDM Dichtung



STARK WIE EIN STIER

# Rohreinmündung 80

## ENTWÄSSERUNG

### CAD-DETAILS

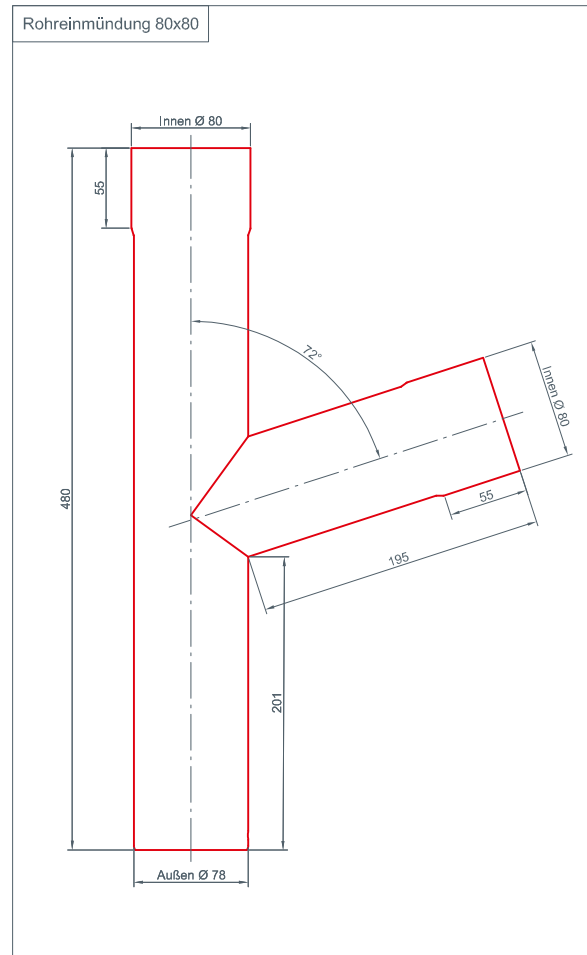
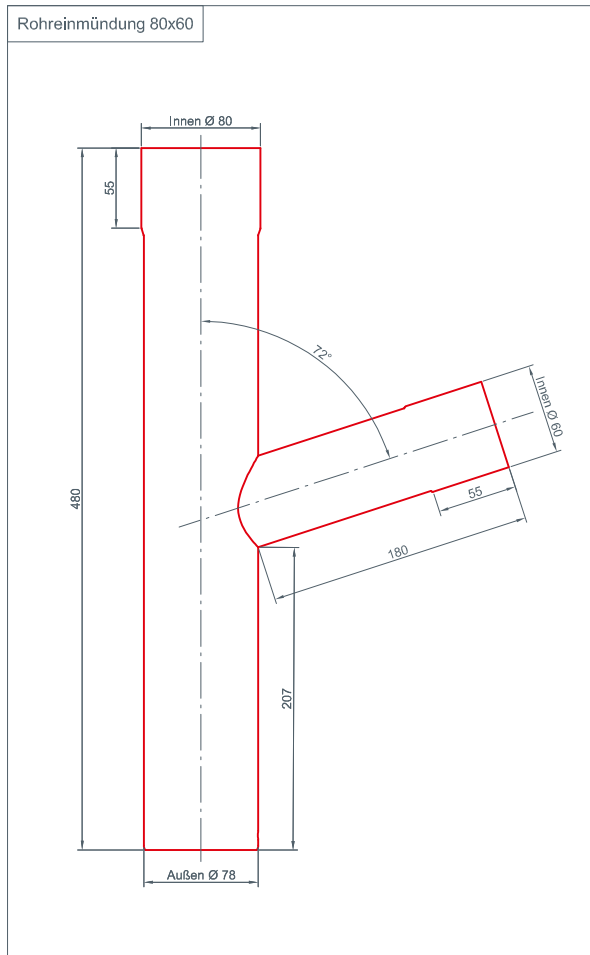



STARK WIE EIN STIER

# Rohreinmündung 100

## ENTWÄSSERUNG

### CAD-DETAILS

Rohreinmündung 100x60

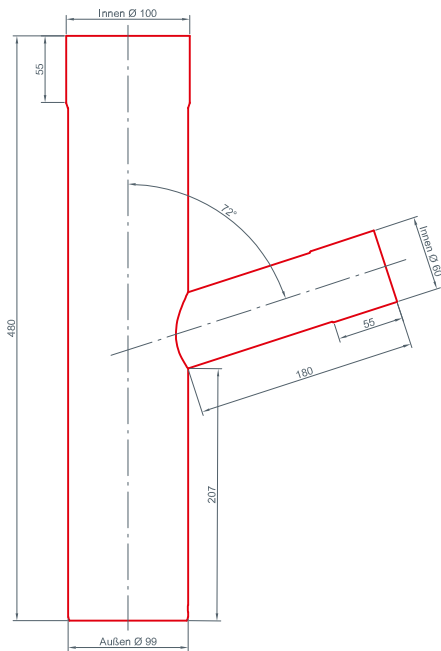

Rohreinmündung 100x80

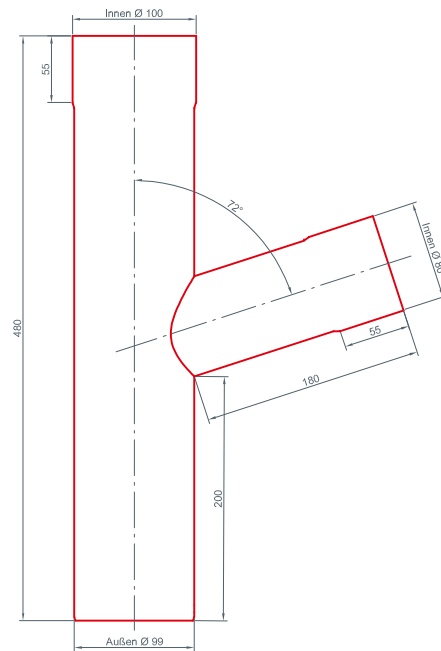

Rohreinmündung 100x100

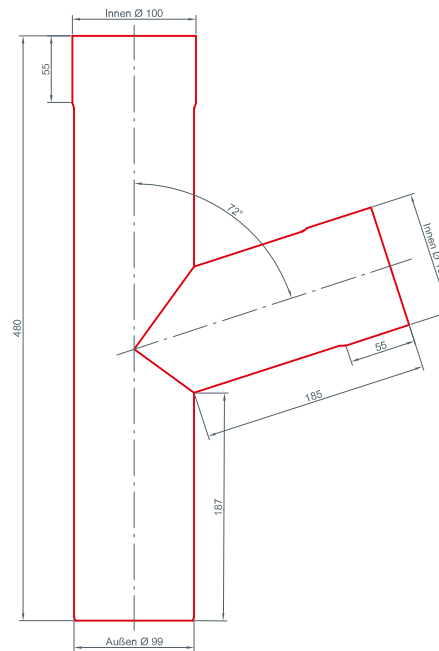

Rohreinmündung 100x50/75

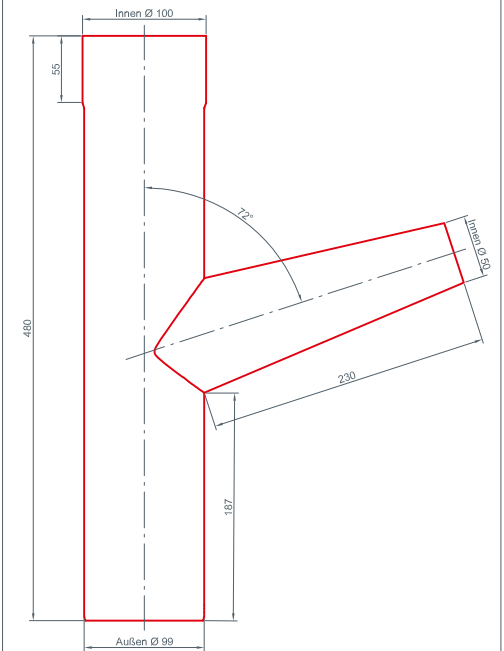





**STARK WIE EIN STIER**

# Rohreimündung 120

## ENTWÄSSERUNG

### CAD-DETAILS

Rohreimündung 120x80

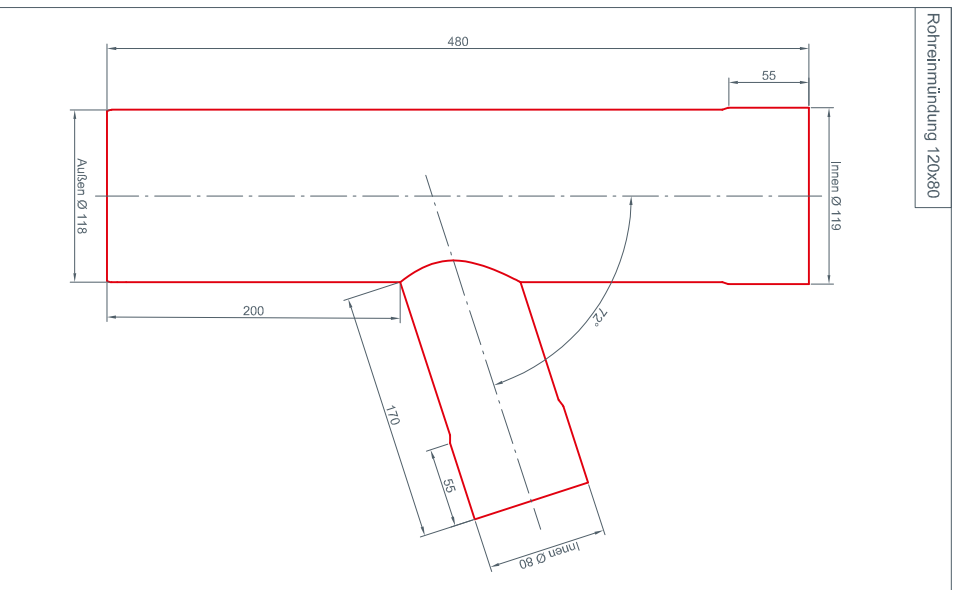

Rohreimündung 120x100

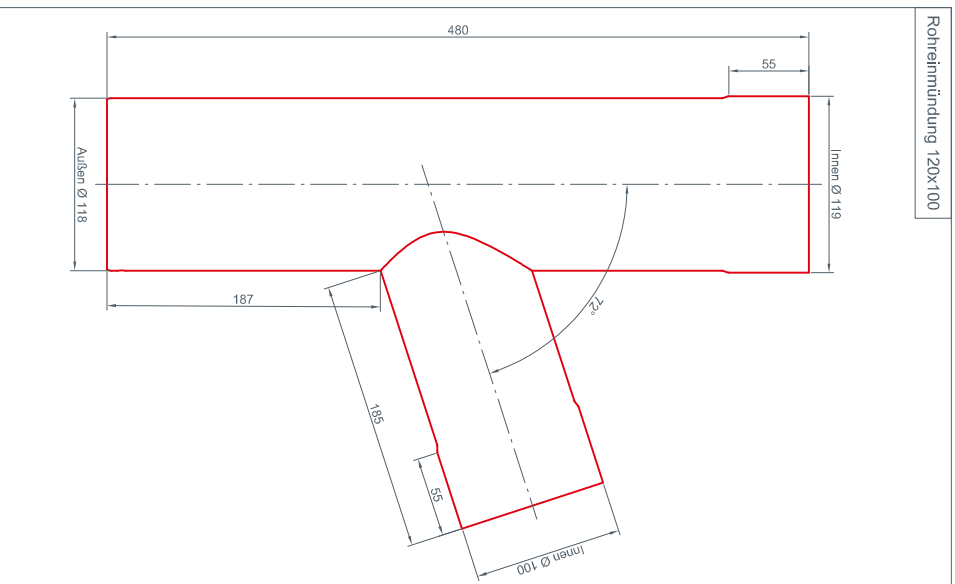

Rohreimündung 120x120

