

Steck-/Trockenmontage-Zargen

Huisseries en deux parties/pour montage à sec

Telai a baionetta/telai - fissaggio con viti

2-teilig für Mauerwerk + Leichtbauwand

2 parties pour mur et parois légère

A 2 pezzi per muro e carton-gesso

Überfälzt, Einfachfalz

A recouvrement, simple battue

Con battuta, battuta semplice

CST.U	06.01.00
ST.UD	06.01.01
F.ST.UD28	06.01.50
NST.UD	06.02.01
H4.ST.UD	06.03.01
H6.ST.UD	06.03.50
B.ST.UD	06.04.01
K4.ST.UD	06.05.01
CST6.U	06.05.80
ST6.UD	06.06.01
ST7.UD	06.10.01

Überfälzt, Doppelfalz

A recouvrement, double battue

Con battuta, Doppia battuta

ST.UDD	06.15.01
--------	----------

Stumpfeinschlagend, Einfachfalz

Exécution affleurée, simple battue

A filo, battuta semplice

ST.UDS	06.20.01
F.ST.UD48	06.20.50
F8.ST.UD57.EI30	06.20.60
NST.UDS	06.21.01
H4.ST.UDS	06.22.01
H6.ST.UDS	06.22.50
B.ST.UDS	06.23.01
K4.ST.UDS	06.24.01
ST1.UDS	06.25.01
ST6.UDS	06.29.01
ST7.UDS	06.30.01

Seitenlicht-Zargen

Huisseries avec partie latérale vitrée

Telaio con parte laterale in vetro

Q1/2.ST.UDS	06.35.01
-------------	----------

Stumpfeinschlagend, Doppelfalz

Exécution affleurée, double battue

A filo, Doppia battuta

ST.UDDS	06.40.01
---------	----------

1-teilig für Mauerwerk

1 partie pour mur / A 1 pezzo per muro

Überfälzt, Einfachfalz

A recouvrement, simple battue

Con battuta, battuta semplice

UD.TM	06.80.01
UD.TM.S	06.80.10
W.UD.TM	06.80.20

Überfälzt, Doppelfalz

A recouvrement, double battue

Con battuta, Doppia battuta

W.UDD.TM	06.82.20
----------	----------

Stumpfeinschlagend, Einfachfalz

Exécution affleurée, simple battue

A filo, battuta semplice

UDS.TM	06.84.01
W.UDS.TM	06.84.20
W.UDS.TM.EI30	06.84.70

Stumpfeinschlagend, Doppelfalz

Exécution affleurée, double battue

A filo, Doppia battuta

W.UDDS.TM	06.86.20
-----------	----------

1-teilig für Leichtbauwand

1 partie pour parois légère

A 1 pezzo per carton-gesso

Überfälzt, Einfachfalz

A recouvrement, simple battue

Con battuta, battuta semplice

C.U.LBW	06.90.00
UD.LBW	06.90.01
UD.LBW4	06.90.02

Überfälzt, Doppelfalz

A recouvrement, double battue

Con battuta, Doppia battuta

UDD.LBW	06.92.01
---------	----------

Stumpfeinschlagend, Einfachfalz

Exécution affleurée, simple battue

A filo, battuta semplice

UDS.LBW4	06.94.00
----------	----------

(Lagerzarge/Huisserie mét. de stock/
Telai in magazzino)



Steck-/Trockenmontage-Zargen

Huisséries en deux parties/pour montage à sec

Telai a baionetta/telai - fissaggio con viti

UDS.LBW	06.94.01
UDS.LBW4	06.94.02
B3.UDS57.LBW.EI30	06.94.04
UDS57.SP.LBW.EI30	06.94.07
N.UDS57.LBW.EI30	06.94.09
W.UDS57.LBW.EI30	06.94.10
NW.UDS57.LBW.EI30	06.94.15
H3.UDS57.LBW.EI30	06.94.18

Stumpfeinschlagend, Doppelfalz ***Exécution affleurée, double battue*** **A filo, Doppia battuta**

UDDS.LBW	06.96.01
----------	----------

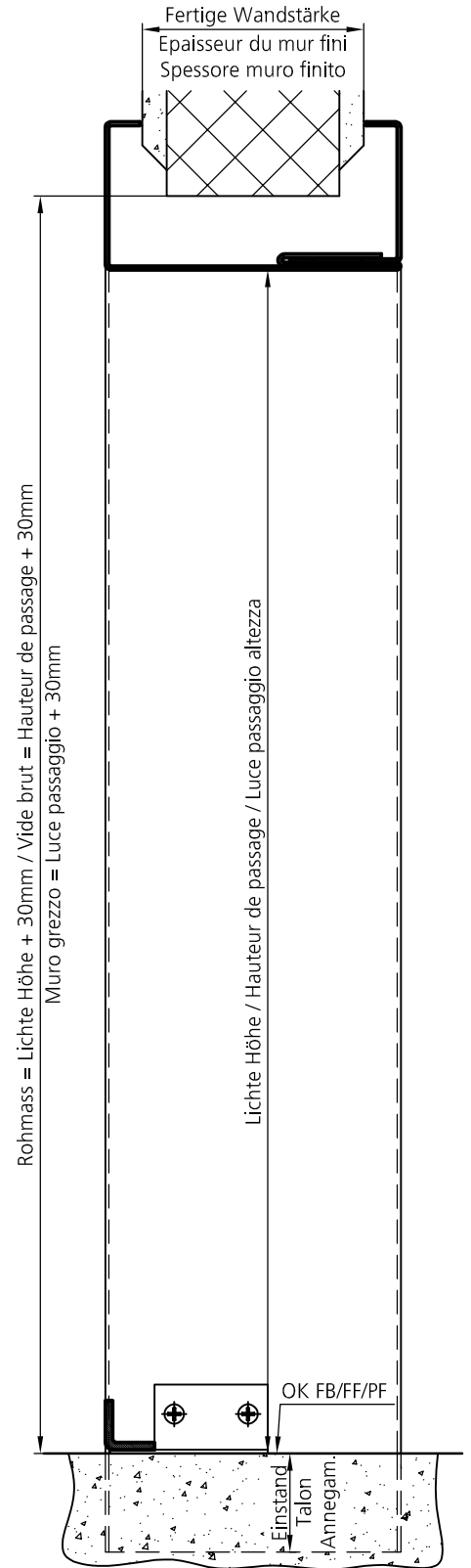
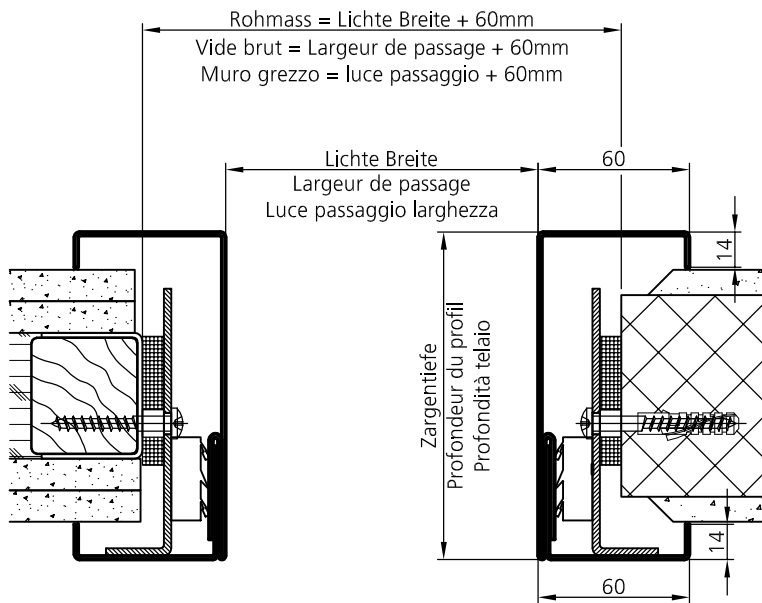
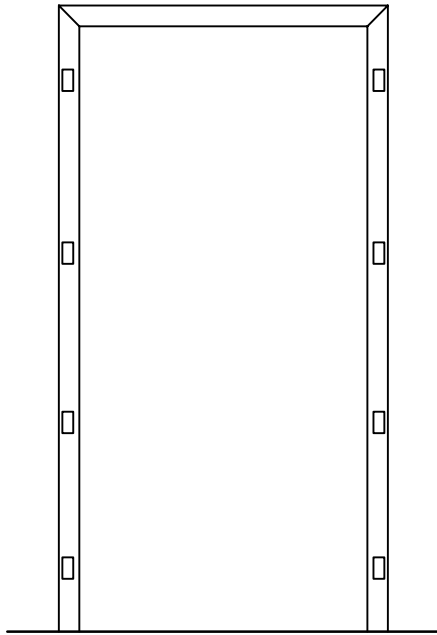

Schreinerdetail Steckzargen / Détails de menuiserie pour huisserie en deux parties / Dettaglio telaio a baionetta per il falegname 09.05.01
 Bestellbeispiel gemäss Seite / Exemple de commande selon page / Esempio ordinazione vedi pagina 01.02.40/41

CST.U

Massstab

Version:

P.Stacher

19.05.2017

1:3

ELKUCH EISENRING AG
 Unterdorfstrasse 26
 CH-9243 Jonschwil



06.01.00

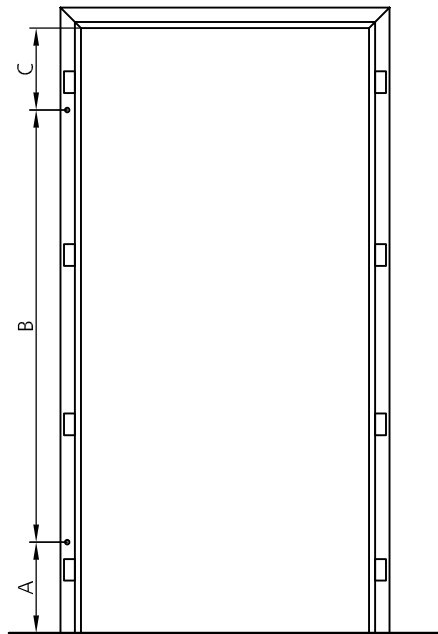

(Gezeichnet: Band links)
 (Dessin: Fiche gauche)
 (Disegnato: cerniere sx)

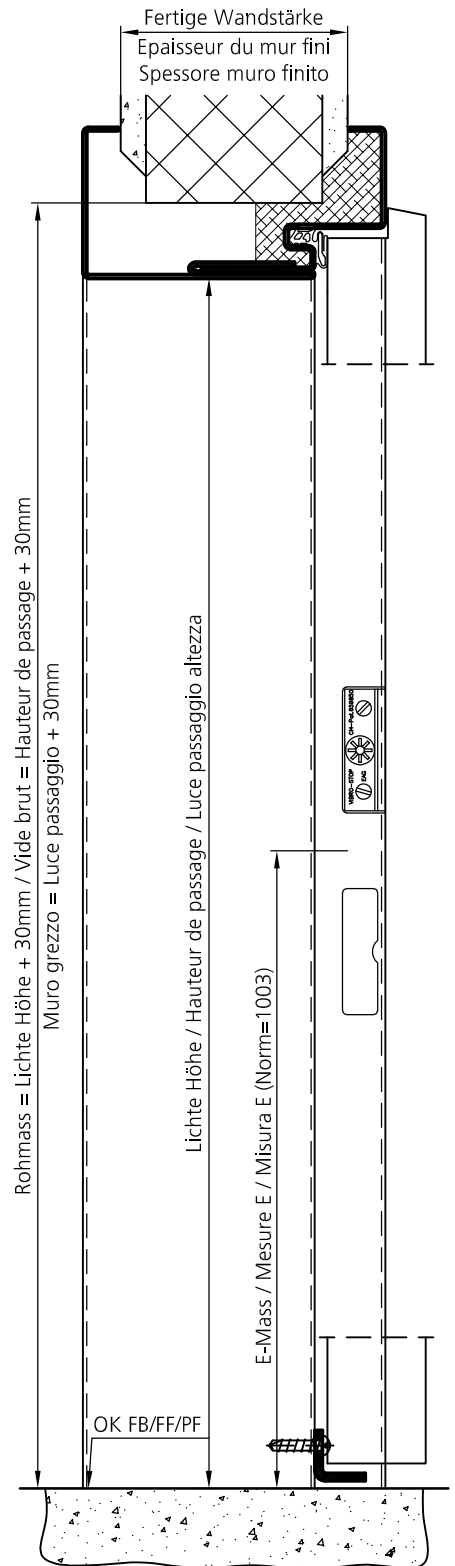
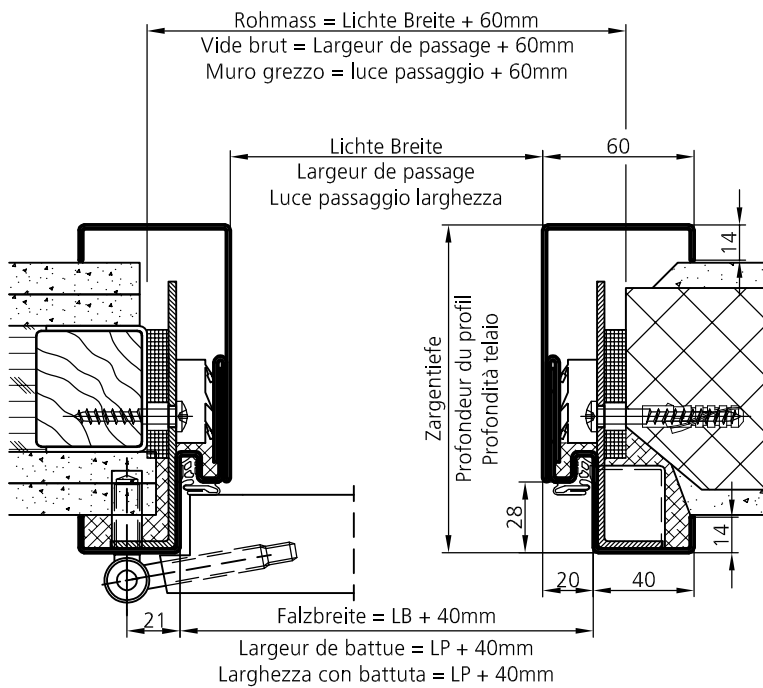

Schreinerdetail Steckzargen / Détails de menuiserie pour huisserie en deux parties / Dettaglio telai a baionetta per il falegname 09.05.01
 EI30 = BS mit Steinwolle isolieren oder schäumen (bauseits) / EI30 = Cadre isolé avec laine de roche ou mousse (fournies par vos soins)
 EI30 = Telaio isolare con lana di roccia o schiumare (a vostro carico)
 Bestellbeispiel gemäss Seite / Exemple de commande selon page / Esempio ordinazione vedi pagina 01.02.40/41

ST.UD

Masstab

Version:

P.Stacher

19.05.2017

1:3

ELKUCH EISENRING AG
 Unterdorfstrasse 26
 CH-9243 Jonschwil



06.01.01

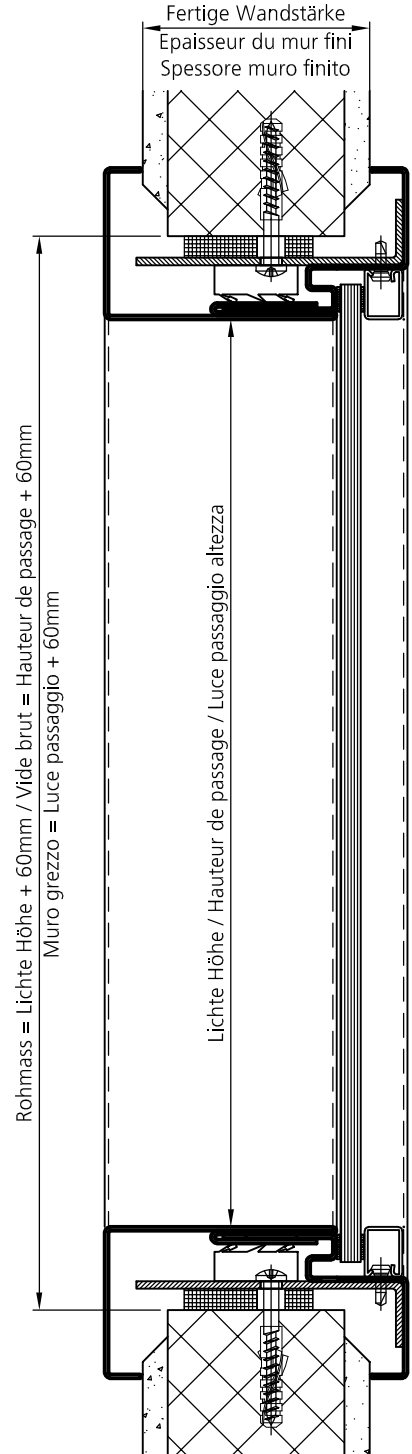
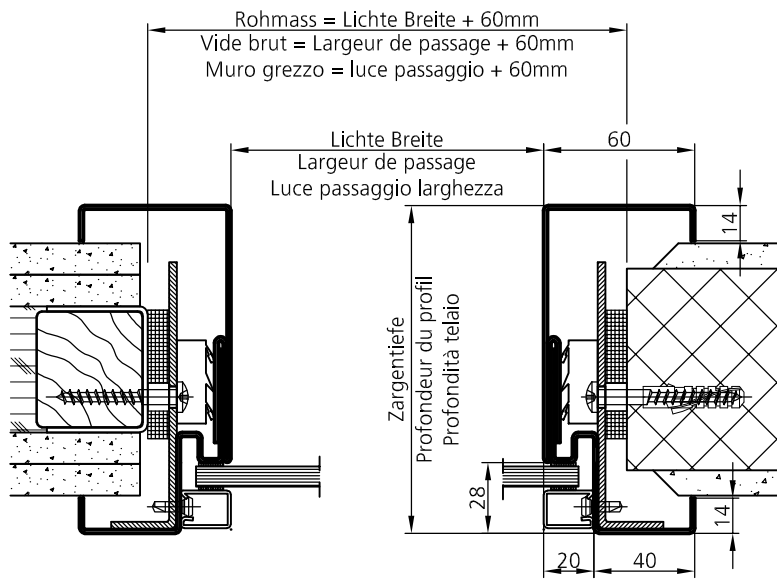
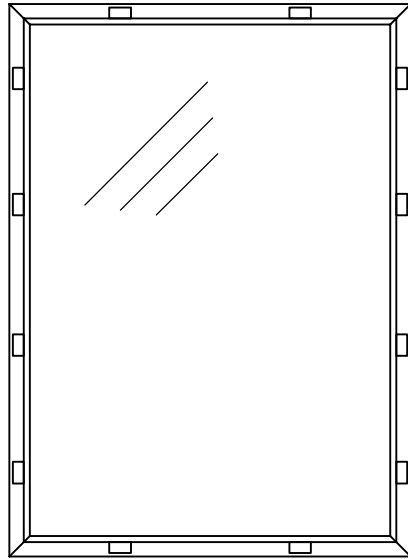

mit Alu- oder Jansen-Glasleisten
 avec baguettes à verre Alu ou Jansen
 ferma-vetri in alu o Jansen

Schreinerdetail Steckzargen / Détails de menuiserie pour huisserie en deux parties / Dettaglio telai a baionetta per il falegname 09.05.01
 Bestellbeispiel gemäss Seite / Exemple de commande selon page / Esempio ordinazione vedi pagina 01.02.40/41

F.ST.UD28

Masstab

Version:

P.Stacher

19.05.2017

1:3

ELKUCH EISENRING AG
 Unterdorfstrasse 26
 CH-9243 Jonschwil

ELKUCH EISENRING

06.01.50

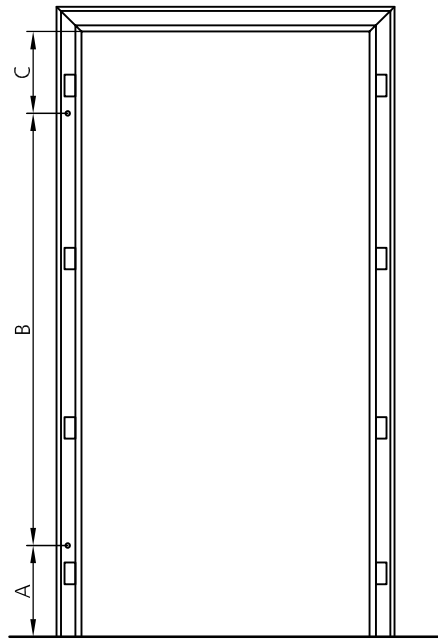

(Gezeichnet: Band links)
(Dessin: Fiche gauche)
(Disegnato: cerniere sx)

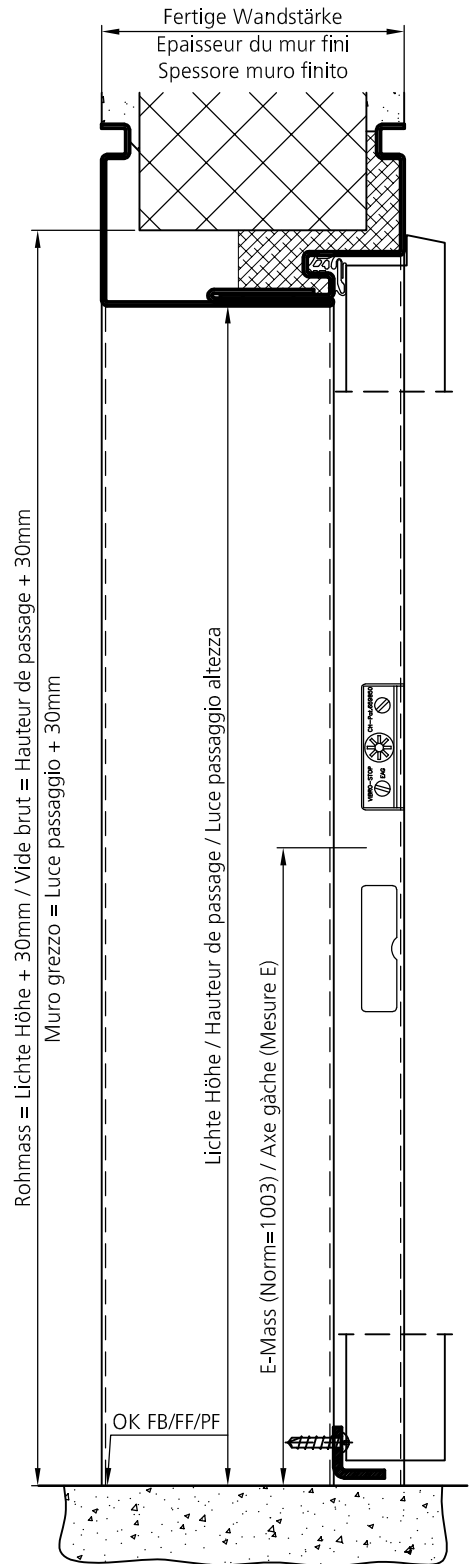
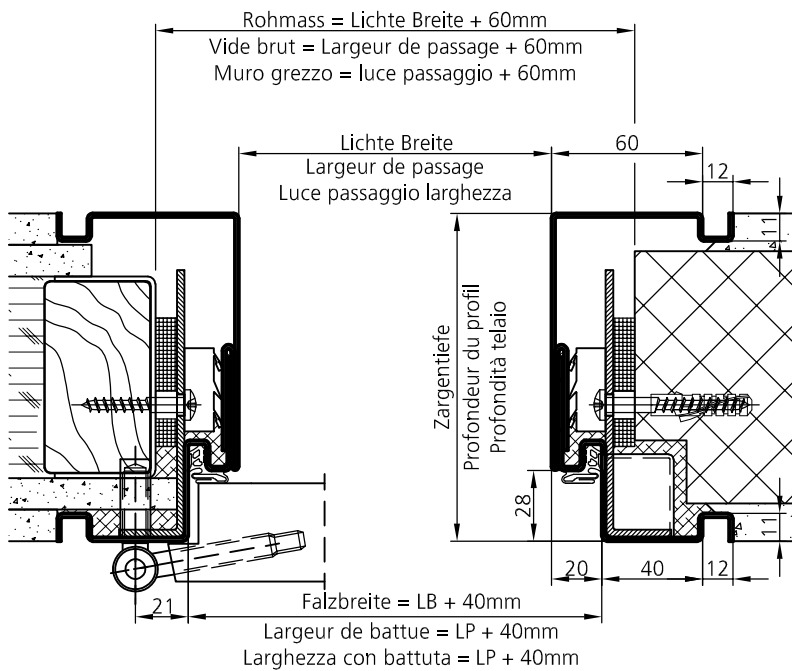

Schreinerdetail Steckzargen / Détails de menuiserie pour huisserie en deux parties / Dettaglio telaio a baionetta per il falegname 09.05.01
EI30 = BS mit Steinwolle isolieren oder schäumen (bauseits) / EI30 = Cadre isolé avec laine de roche ou mousse (fournies par vos soins)
EI30 = Telaio isolare con lana di roccia o schiumare (a vostro carico)
Bestellbeispiel gemäss Seite / Exemple de commande selon page / Esempio ordinazione vedi pagina 01.02.40/41

NST.UD

Masstab

Version:

P.Stacher

19.05.2017

1:3

ELKUCH EISENRING AG
Unterdorfstrasse 26
CH-9243 Jonschwil



06.02.01

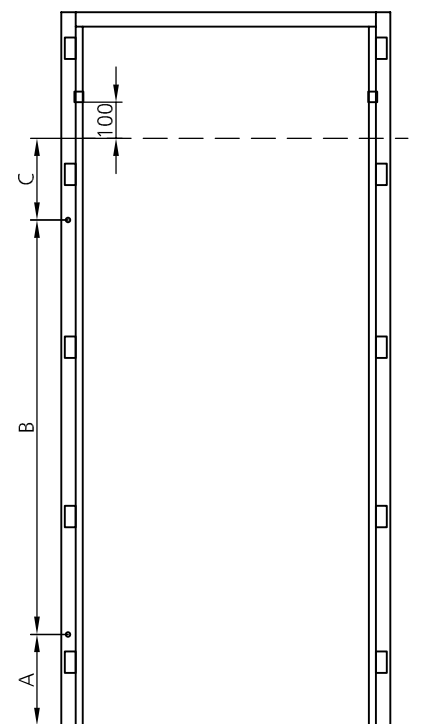

(Gezeichnet: Band links)
 (Dessin: Fiche gauche)
 (Disegnato: cerniere sx)

Detail: Blendenbefestigung
 Détail: fixation attique
 Dettaglio: fissaggio del sopraluce

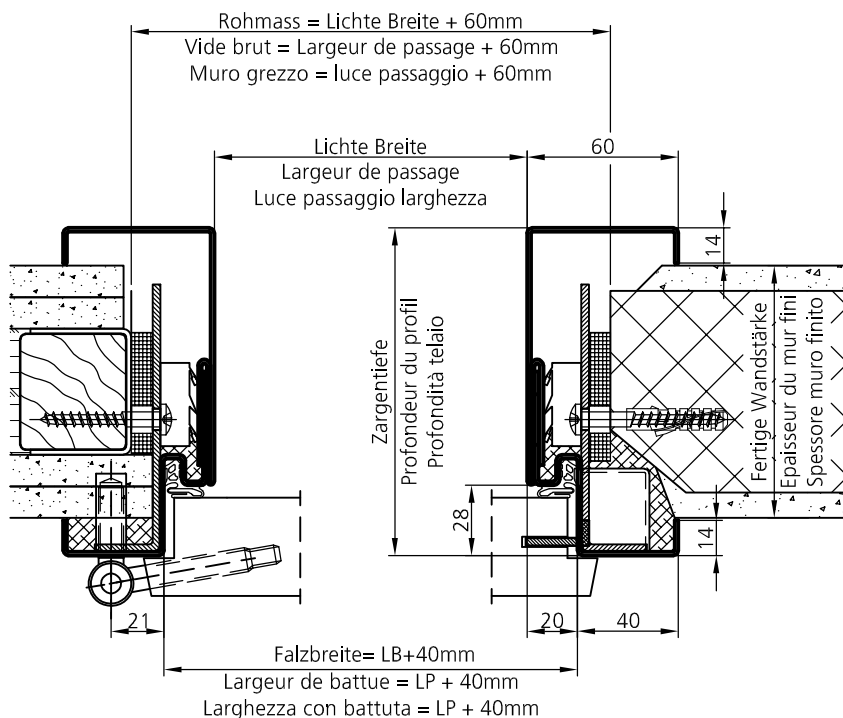
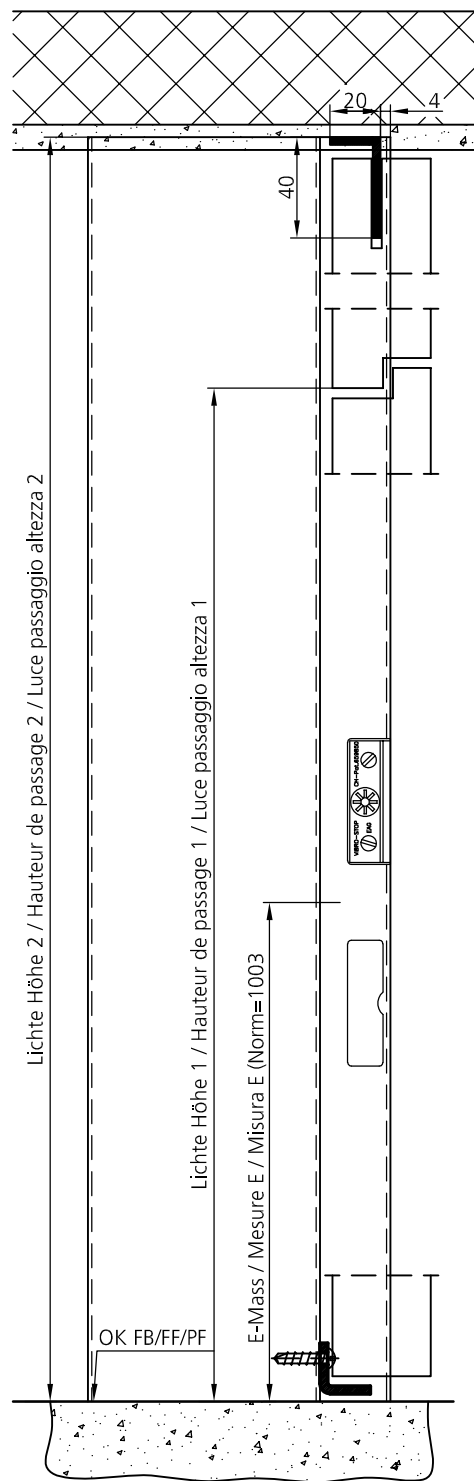
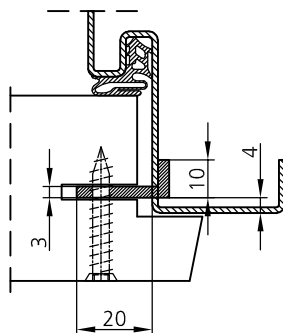

Schreinerdetail Steckzargen / Détails de menuiserie pour huisserie en deux parties / Dettaglio telaio a baionetta per il falegname 09.05.01
 EI30 = BS mit Steinwolle isolieren oder schäumen (bauseits) / EI30 = Cadre isolé avec laine de roche ou mousse (fournies par vos soins)
 EI30 = Telaio isolare con lana di roccia o schiumare (a vostro carico)
 Bestellbeispiel gemäss Seite / Exemple de commande selon page / Esempio ordinazione vedi pagina 01.02.40/41

H4.ST.UD	Massstab	Version:	P.Stacher	19.05.2017
	1:3	ELKUCH EISENRING AG Unterdorfstrasse 26 CH-9243 Jonschwil		
		06.03.01		

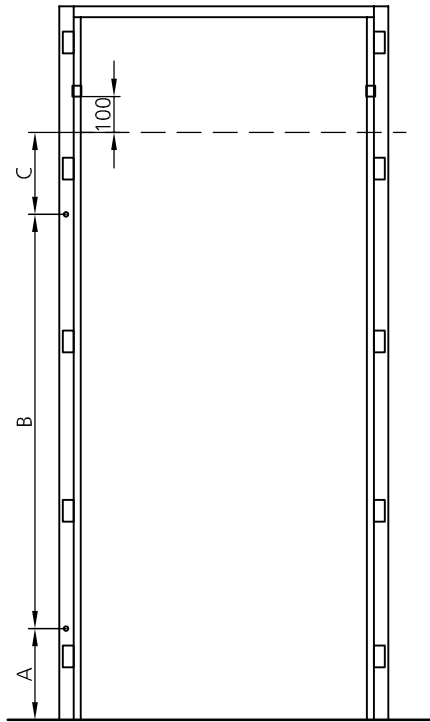

(Gezeichnet: Band links)
 (Dessin: Fiche gauche)
 (Disegnato: cerniere sx)

Detail: Blendenbefestigung
 Détail: fixation attique
 Dettaglio: fissaggio del sopra luce

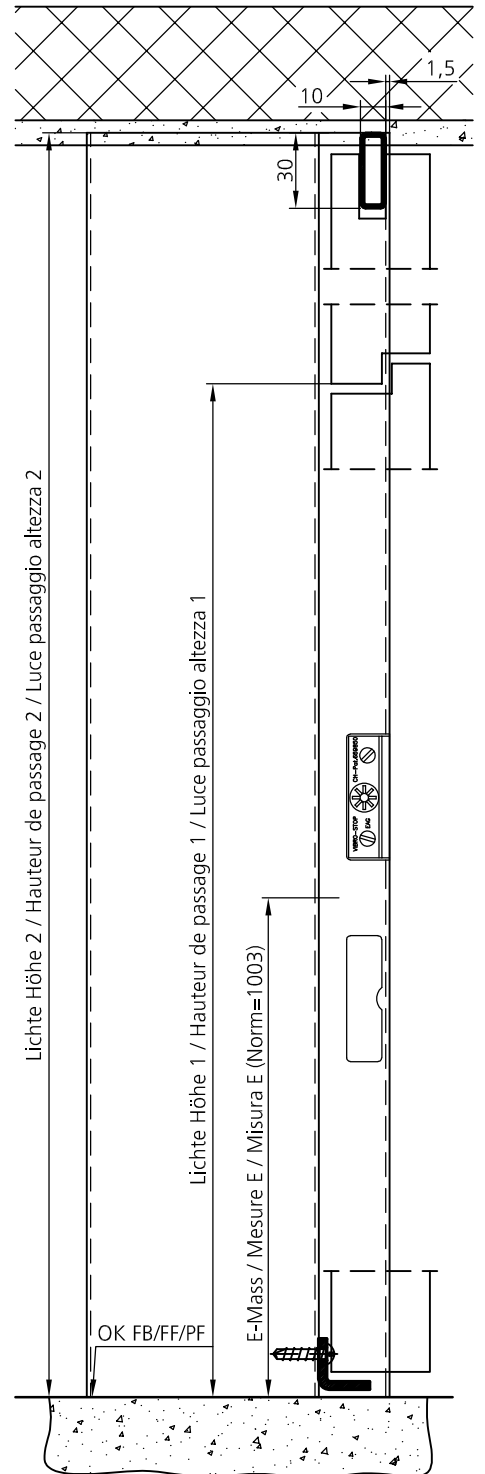
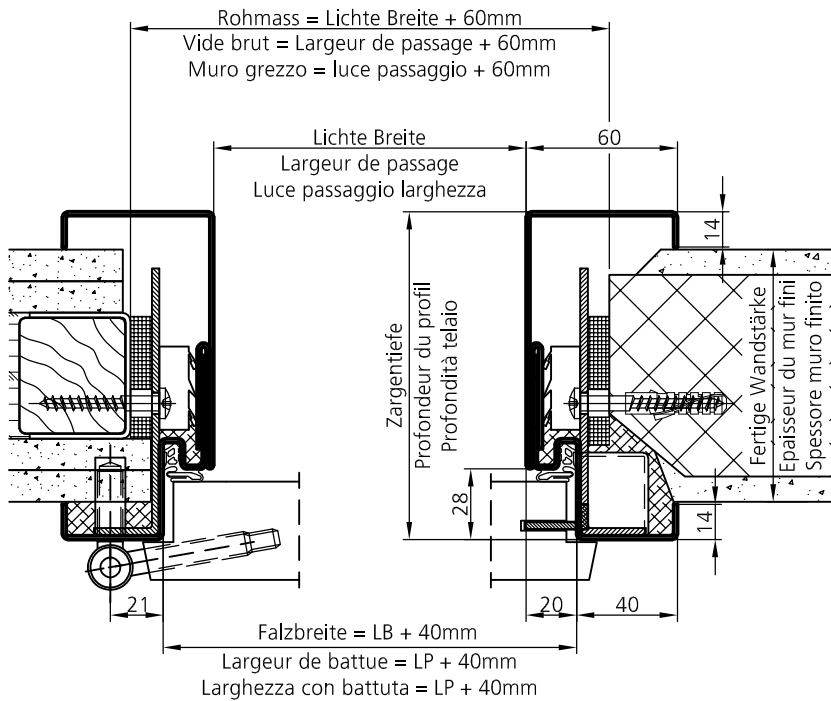
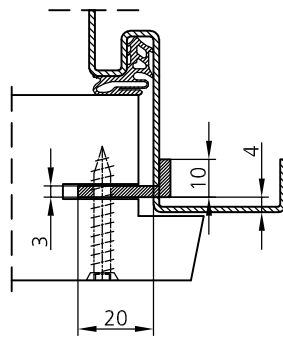

Schreinerdetail Steckzargen / Détails de menuiserie pour huisserie en deux parties / Dettaglio telai a baionetta per il falegname 09.05.01
 EI30 = BS mit Steinwolle isolieren oder schäumen (bauseits) / EI30 = Cadre isolé avec laine de roche ou mousse (fournies par vos soins)
 EI30 = Telaio isolare con lana di roccia o schiumare (a vostro carico)
 Bestellbeispiel gemäss Seite / Exemple de commande selon page / Esempio ordinazione vedi pagina 01.02.40/41

H6.ST.UD	Massstab	Version:	P.Stacher	19.05.2017
	1:3	ELKUCH EISENRING AG Unterdorfstrasse 26 CH-9243 Jonschwil		
		06.03.50		

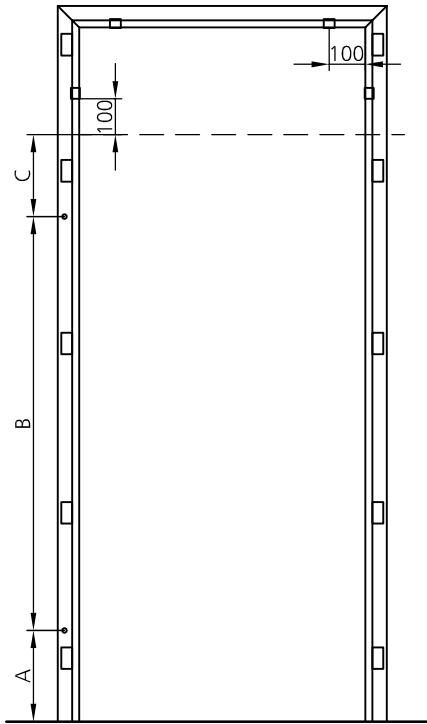

(Gezeichnet: Band links)
 (Dessin: Fiche gauche)
 (Disegnato: cerniere sx)

Detail: Blendenbefestigung
 Détail: fixation attique
 Dettaglio: fissaggio del sopraluce

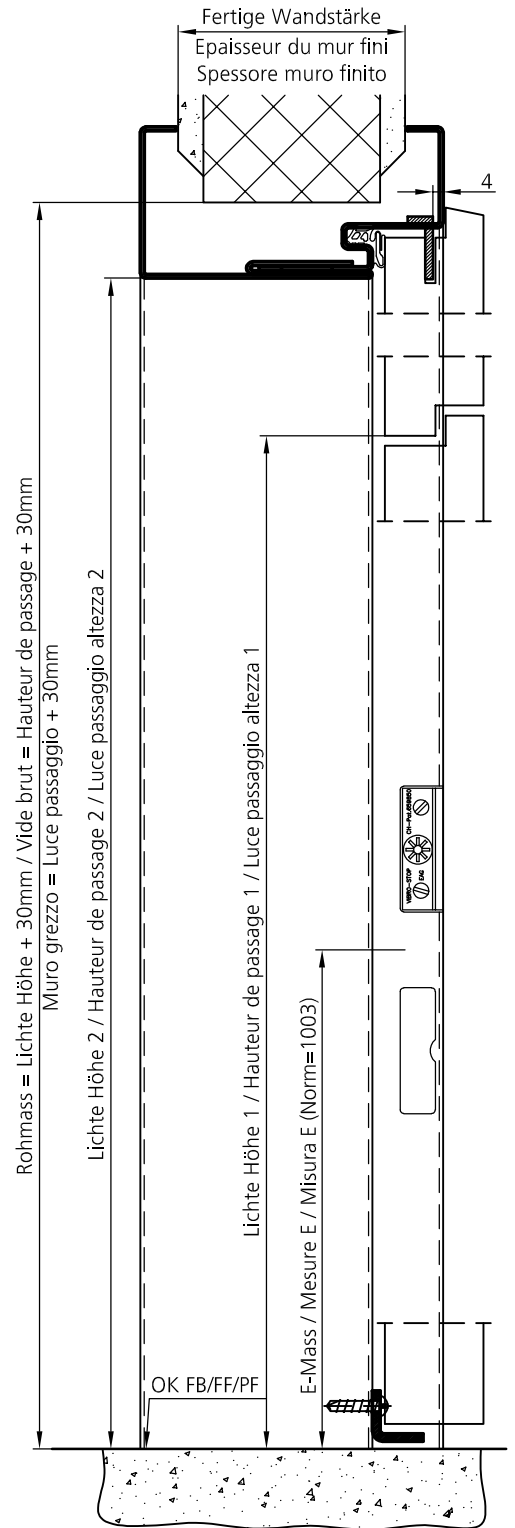
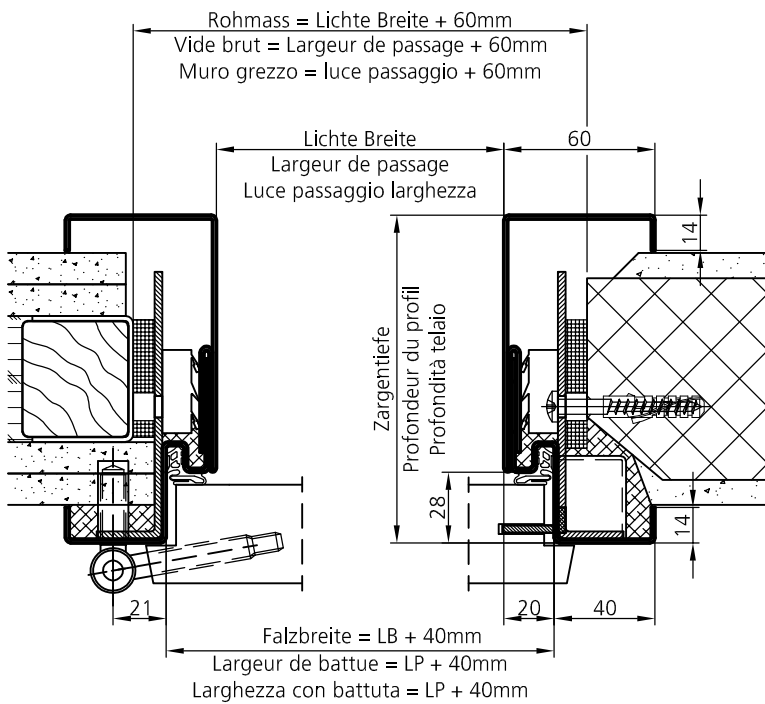
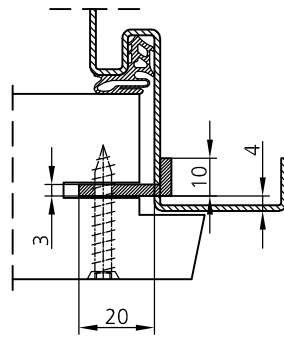

Schreinerdetail Steckzargen / Détails de menuiserie pour huisserie en deux parties / Dettaglio telai a baionetta per il falegname 09.05.01
 EI30 = BS mit Steinwolle isolieren oder schäumen (bauseits) / EI30 = Cadre isolé avec laine de roche ou mousse (fournies par vos soins)
 EI30 = Telaio isolare con lana di roccia o schiumare (a vostro carico)
 Bestellbeispiel gemäss Seite / Exemple de commande selon page / Esempio ordinazione vedi pagina 01.02.40/41

B.ST.UD

Masstab

Version:

P.Stacher

23.06.2017

1:3

ELKUCH EISENRING AG
 Unterdorfstrasse 26
 CH-9243 Jonschwil



06.04.01

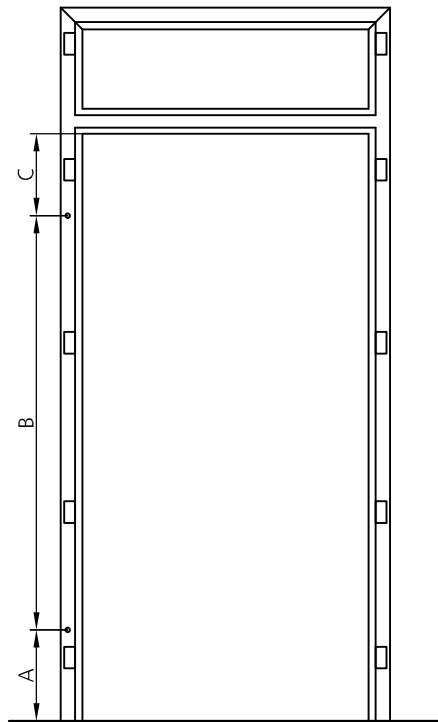

(Gezeichnet: Band links)
 (Dessin: Fiche gauche)
 (Disegnato: cerniere sx)

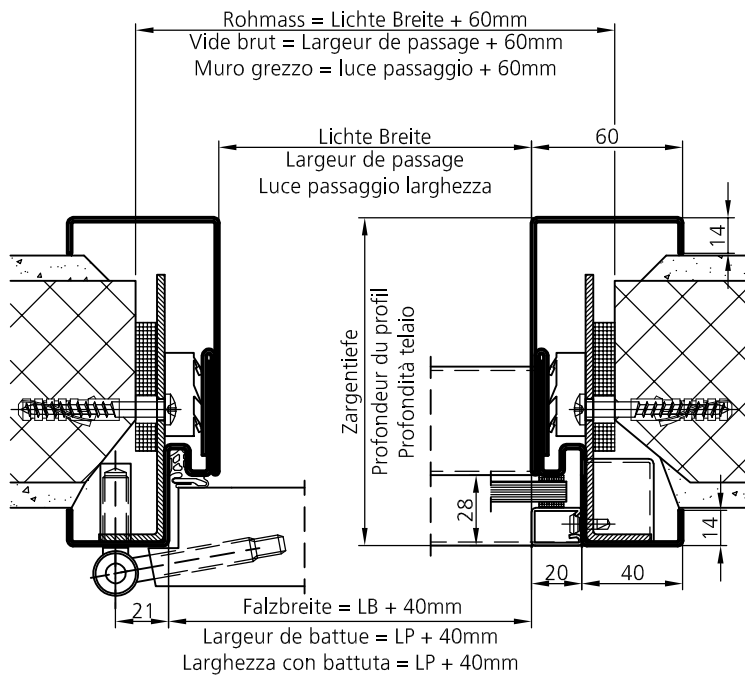

mit Jansen-Glasleisten
avec baguettes Jansen
ferma-vetri in Jansen

Schreinerdetail Steckzargen / Détails de menuiserie pour huisserie en deux parties / Dettaglio telai a baionetta per il falegname 09.05.01
 Bestellbeispiel gemäss Seite / Exemple de commande selon page / Esempio ordinazione vedi pagina 01.02.40/41

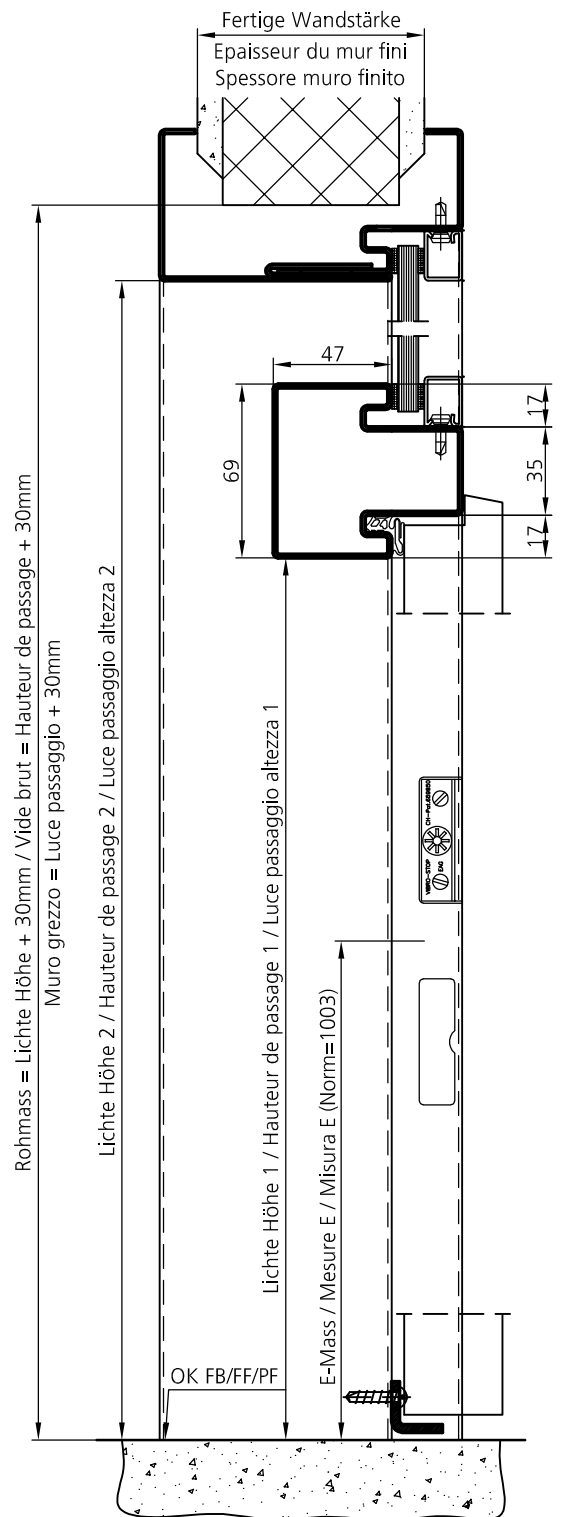

K4.ST.UD



Masstab Version: P.Stacher 04.03.2014

1:3

ELKUCH EISENRING AG
 Unterdorfstrasse 26
 CH-9243 Jonschwil

06.05.01

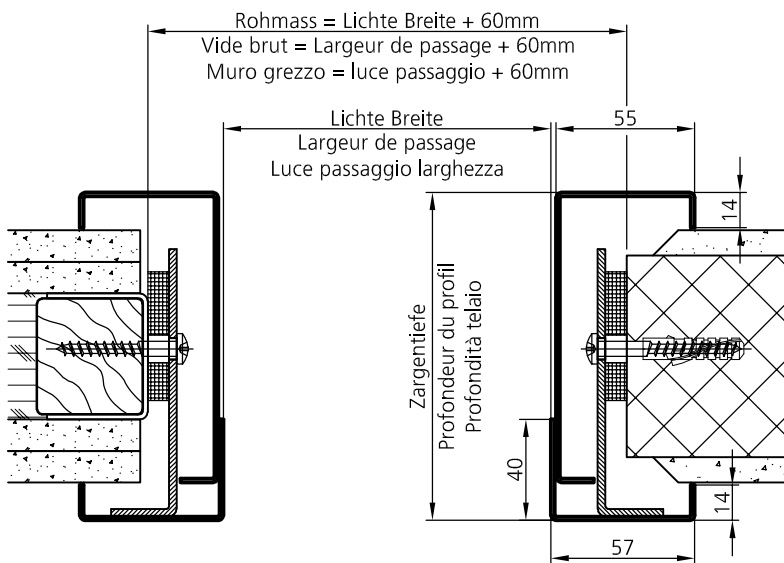
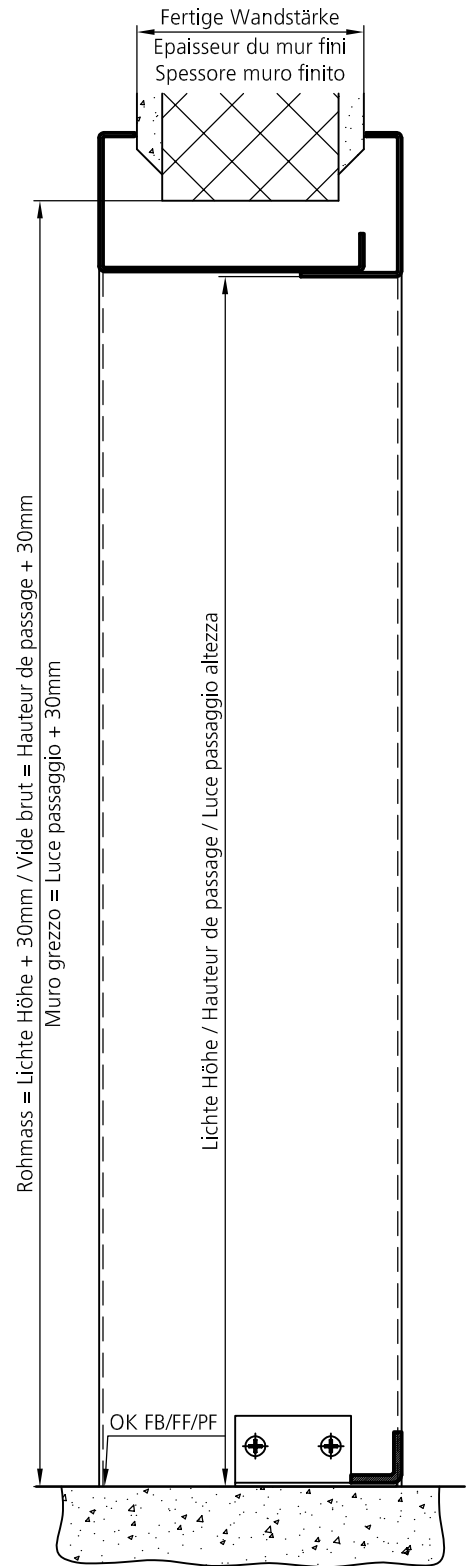
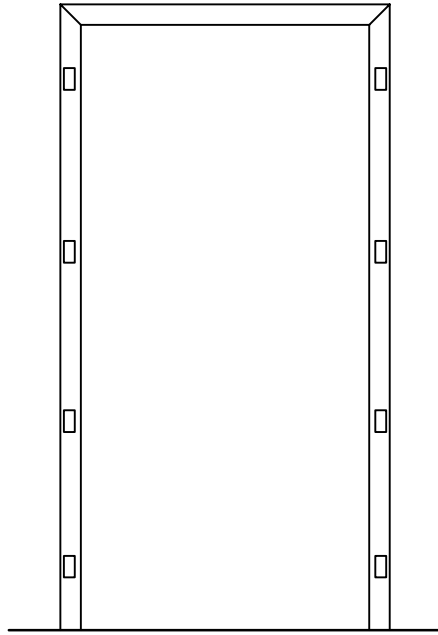

Schreinerdetail Steckzargen / Détails de menuiserie pour huisserie en deux parties / Dettaglio telai a baionetta per il falegname 09.05.01
Bestellbeispiel gemäss Seite / Exemple de commande selon page / Esempio ordinazione vedi pagina 01.02.40/41

CST6.U

Masstab Version: P.Stacher 19.05.2017

1:3

ELKUCH EISENRING AG
Unterdorfstrasse 26
CH-9243 Jonschwil



06.05.80

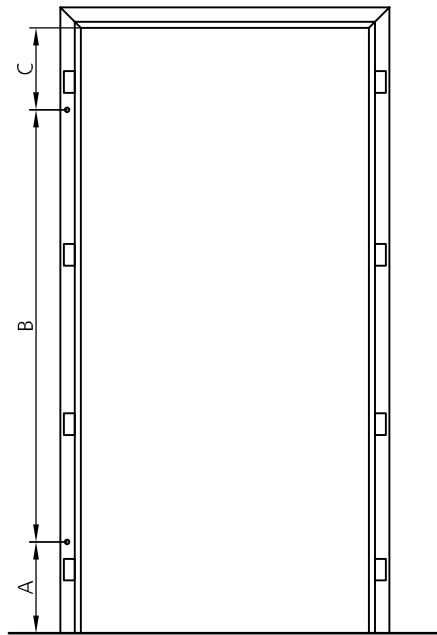

(Gezeichnet: Band links)
(Dessin: Fiche gauche)
(Disegnato: cerniere sx)

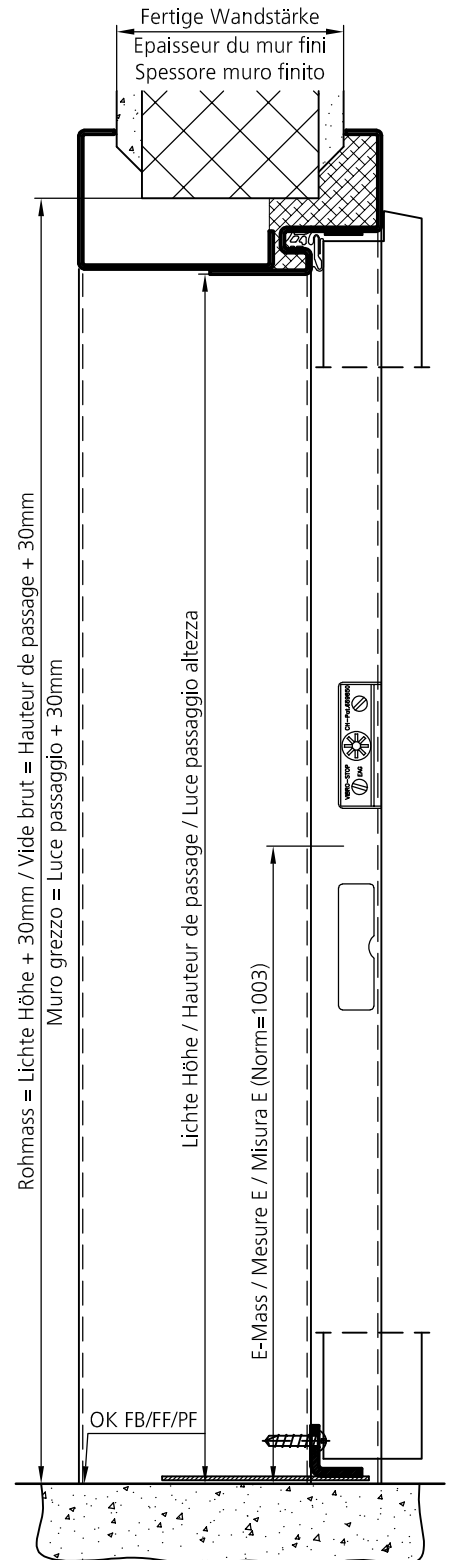
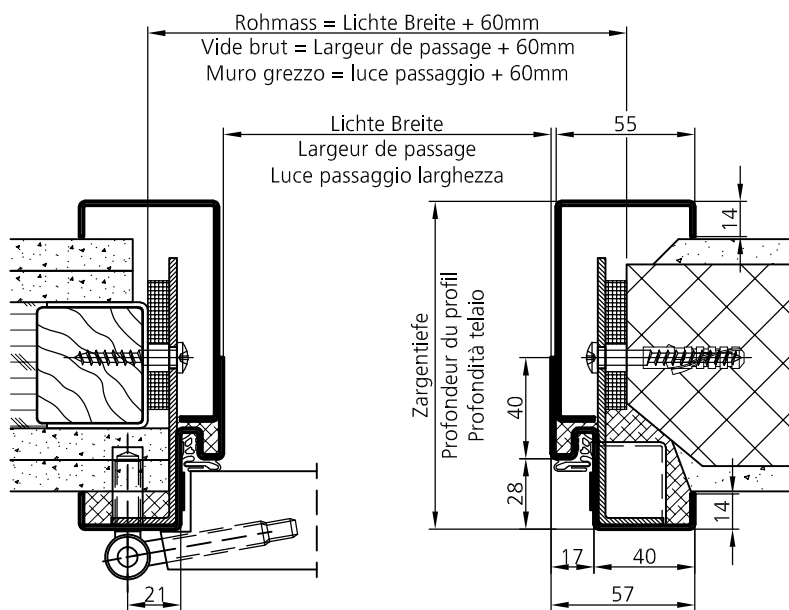

Schreinerdetail Steckzargen / Détails de menuiserie pour huisserie en deux parties / Dettaglio telaio a baionetta per il falegname 09.05.01
 EI30 = BS mit Steinwolle isolieren oder schäumen (bauseits) / EI30 = Cadre isolé avec laine de roche ou mousse (fournies par vos soins)
 EI30 = Telaio isolare con lana di roccia o schiumare (a vostro carico)
 Bestellbeispiel gemäss Seite / Exemple de commande selon page / Esempio ordinazione vedi pagina 01.02.40/41

ST6.UD

Masstab Version: P.Stacher 19.05.2017

1:3

ELKUCH EISENRING AG
 Unterdorfstrasse 26
 CH-9243 Jonschwil



06.06.01

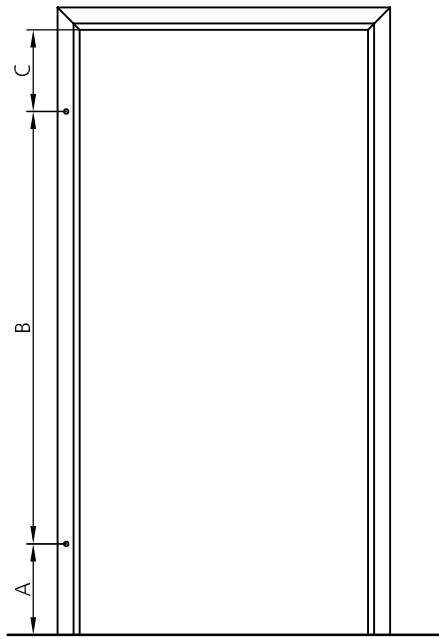

(Gezeichnet: Band links)
(Dessin: Fiche gauche)
(Disegnato: cerniere sx)

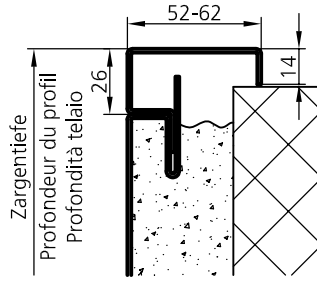

Variante: E1
(ST7.UD.E1)

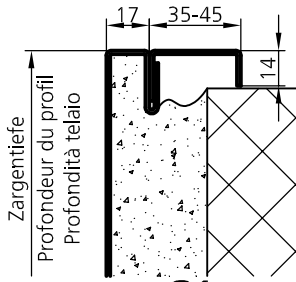

Variante: G1
(ST7.UD.G1)

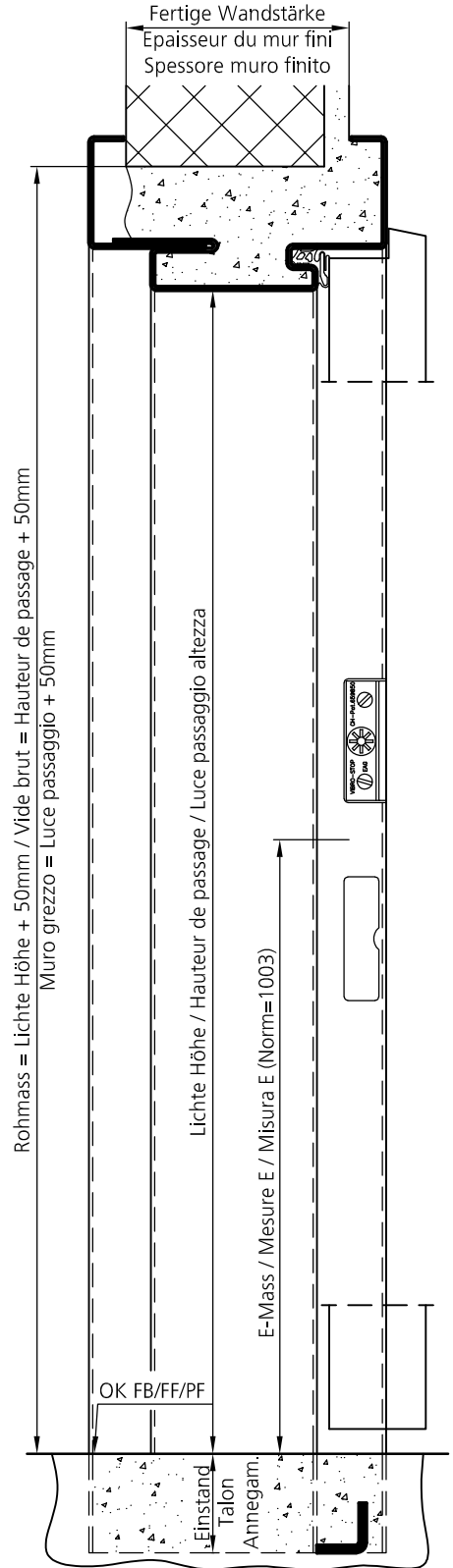
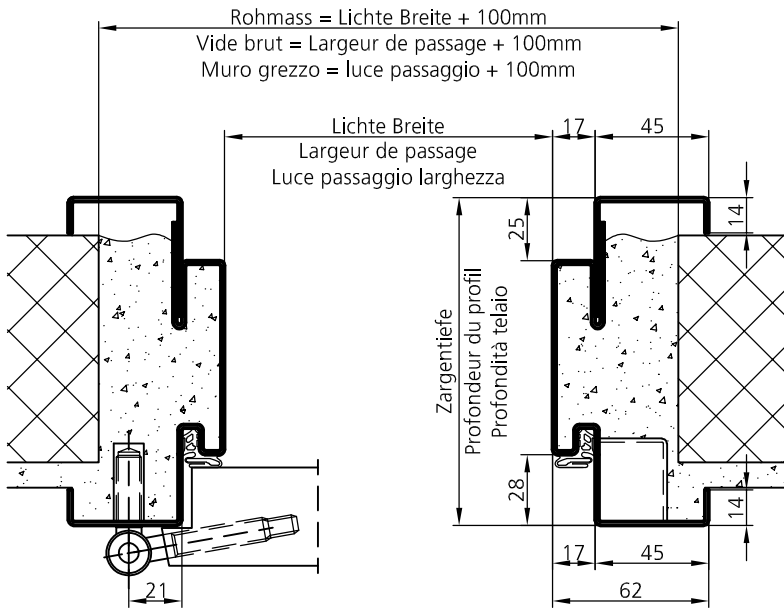

Bestellbeispiel gemäss Seite / Exemple de commande selon page / Esempio ordinazione vedi pagina 01.02.40/41

ST7.UD

Masstab

Version:

P.Stacher

19.05.2017

1:3

ELKUCH EISENRING AG
Unterdorfstrasse 26
CH-9243 Jonschwil



06.10.01

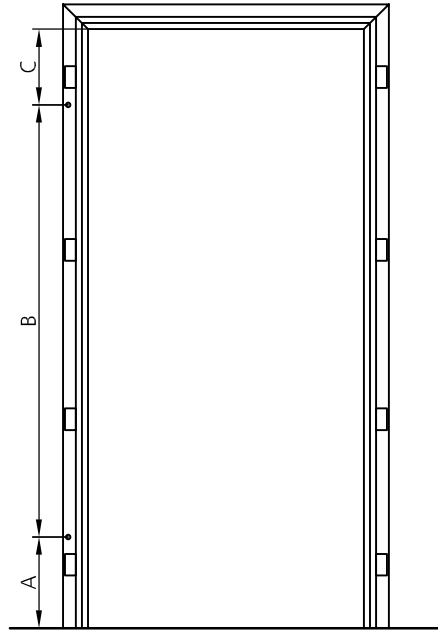

(Gezeichnet: Band links)
(Dessin: Fiche gauche)
(Disegnato: cerniere sx)

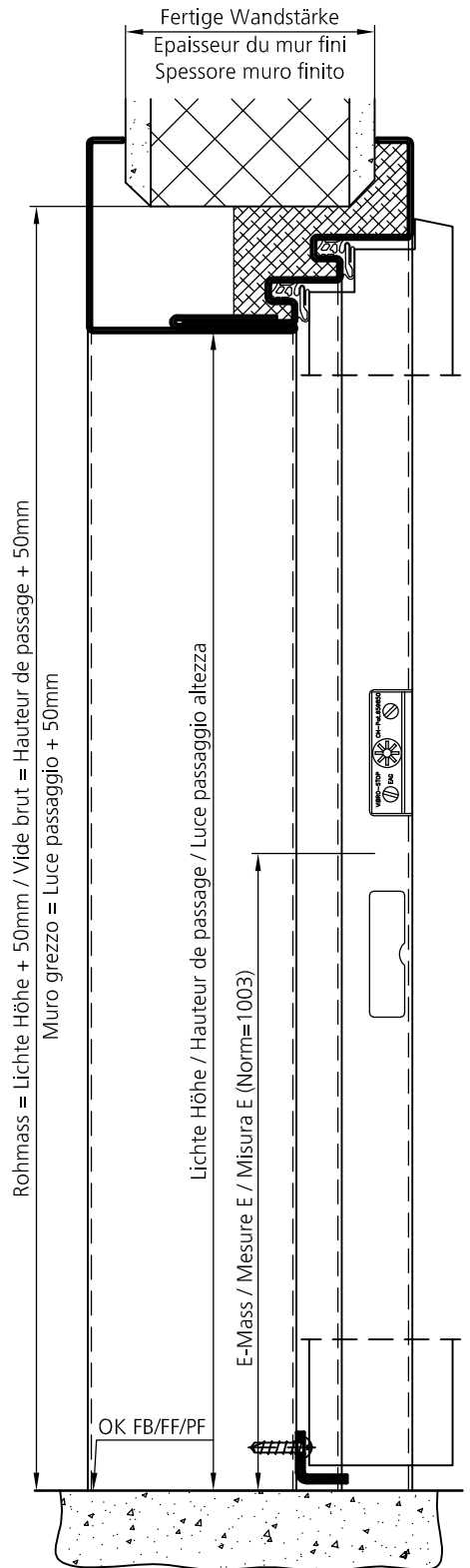
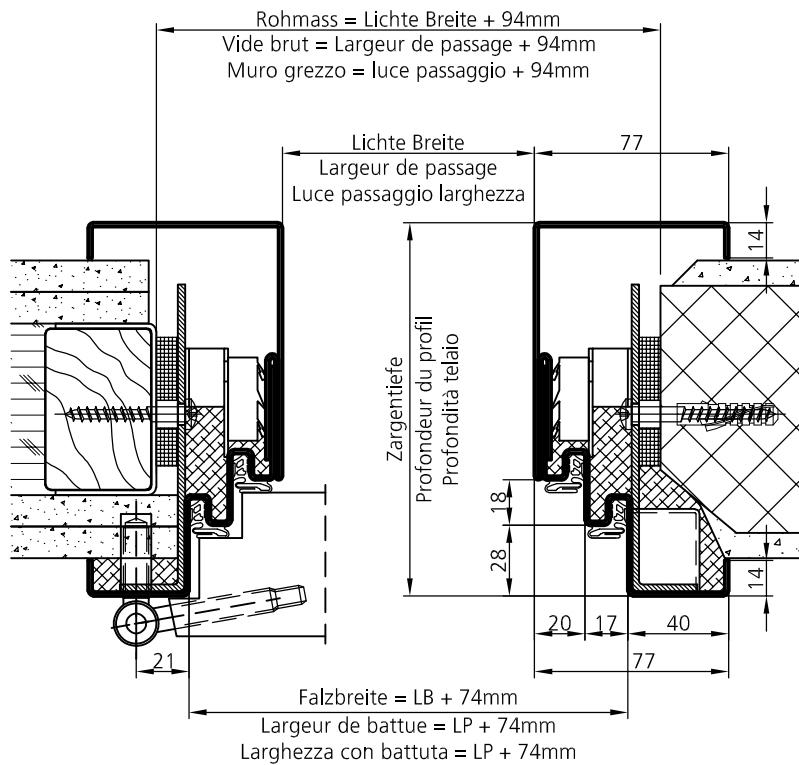

Schreinerdetail Steckzargen / Détails de menuiserie pour huisserie en deux parties / Dettaglio telai a baionetta per il falegname 09.05.01
EI30 = BS mit Steinwolle isolieren oder schäumen (bauseits) / EI30 = Cadre isolé avec laine de roche ou mousse (fournies par vos soins)
EI30 = Telaio isolare con lana di roccia o schiumare (a vostro carico)
Bestellbeispiel gemäss Seite / Exemple de commande selon page / Esempio ordinazione vedi pagina 01.02.40/41

ST.UDD

Masstab

Version:

P.Stacher

19.05.2017

1:3

ELKUCH EISENRING AG
Unterdorfstrasse 26
CH-9243 Jonschwil

ELKUCH EISENRING

06.15.01

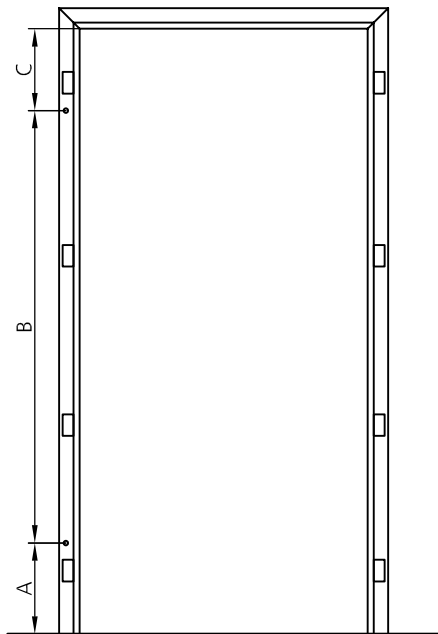

(Gezeichnet: Band links)
 (Dessin: Fiche gauche)
 (Disegnato: cerniere sx)

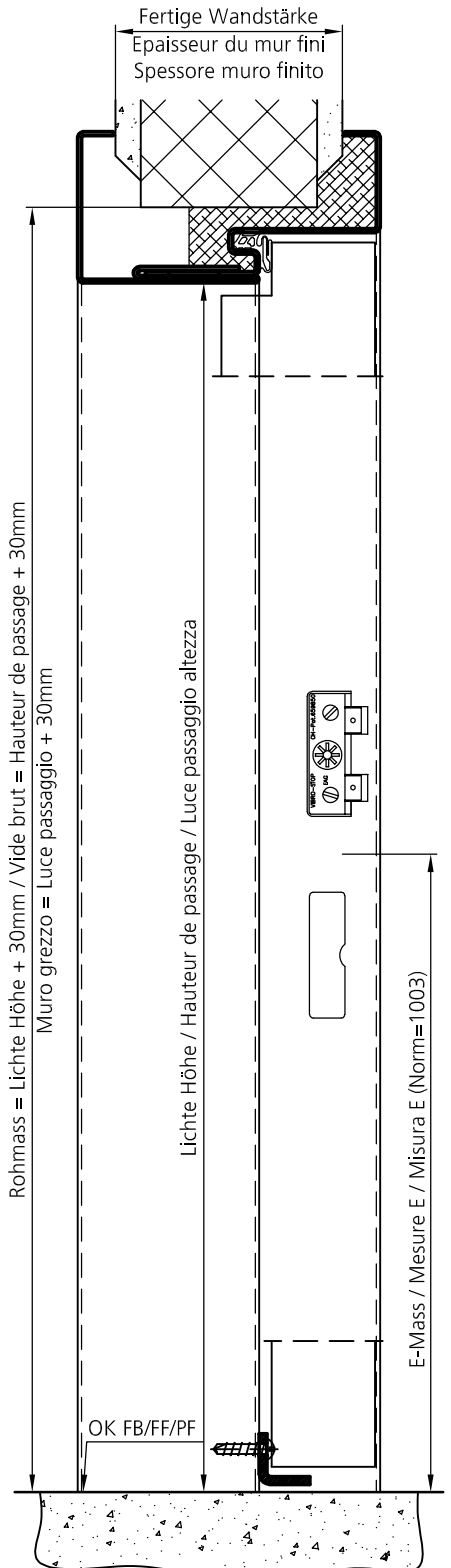
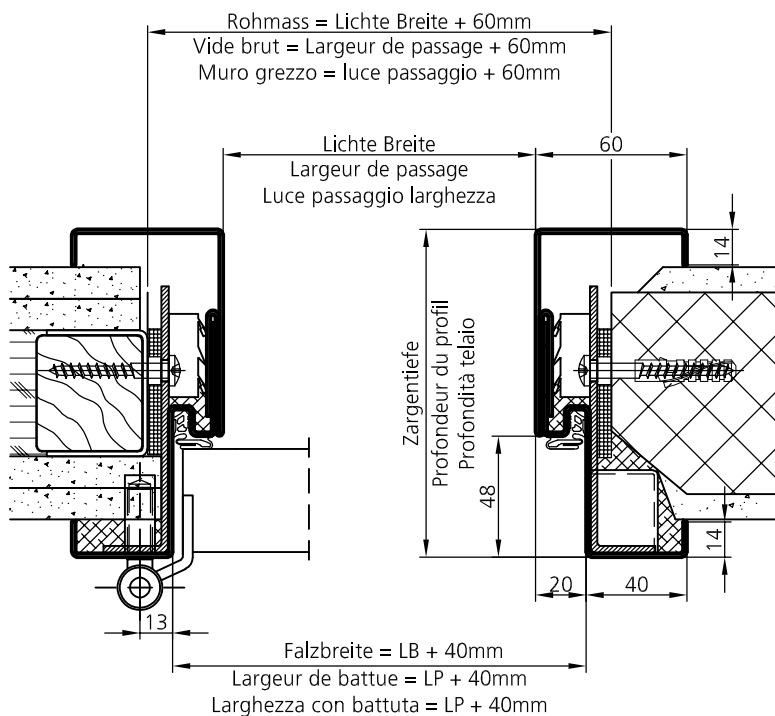

Schreinerdetail Steckzargen / Détails de menuiserie pour huisserie en deux parties / Dettaglio telaio a baionetta per il falegname 09.05.01
 EI30 = BS mit Steinwolle isolieren oder schäumen (bauseits) / EI30 = Cadre isolé avec laine de roche ou mousse (fournies par vos soins)
 EI30 = Telaio isolare con lana di roccia o schiumare (a vostro carico)
 Bestellbeispiel gemäss Seite / Exemple de commande selon page / Esempio ordinazione vedi pagina 01.02.40/41

ST.UDS

Masstab Version: P.Stacher 23.06.2017

1:3

ELKUCH EISENRING AG
 Unterdorfstrasse 26
 CH-9243 Jonschwil



06.20.01

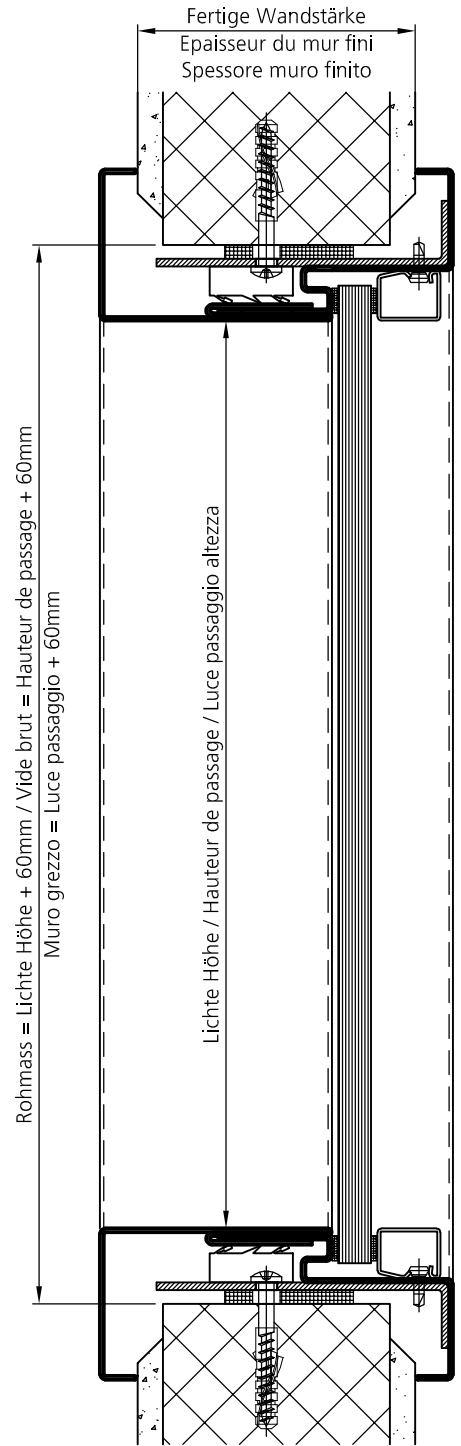
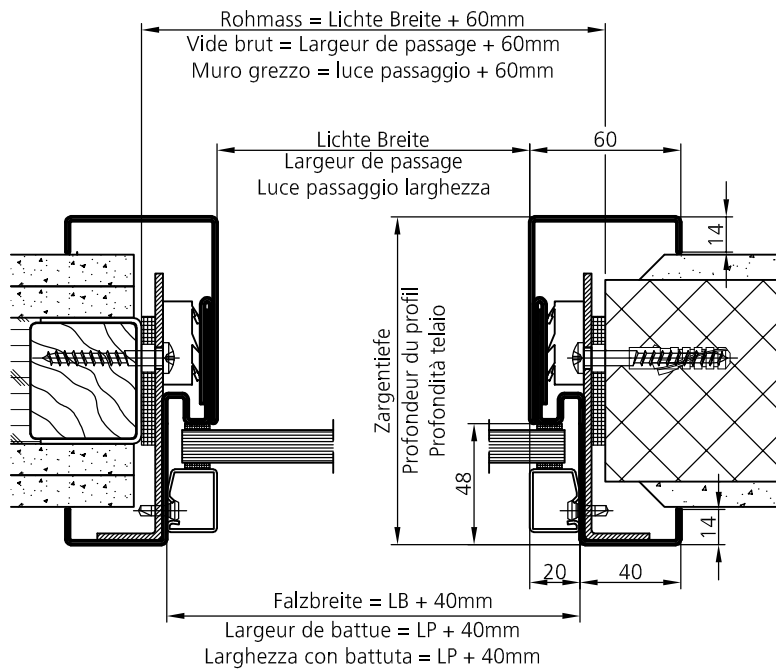
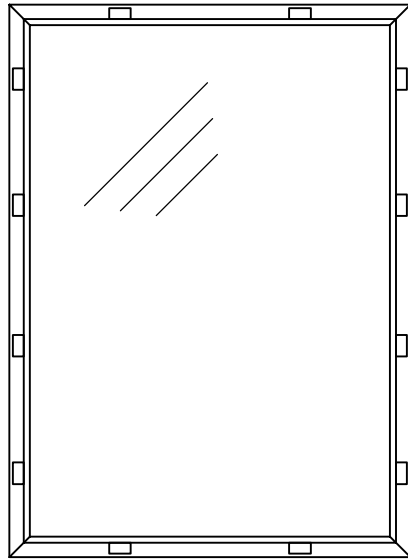

mit Alu- oder Jansen-Glasleisten
avec baguettes à verre Alu ou Jansen
ferma-vetri in alu o Jansen

Schreinerdetail Steckzargen / Détails de menuiserie pour huisserie en deux parties / Dettaglio telai a baionetta per il falegname 09.05.01
 Bestellbeispiel gemäss Seite / Exemple de commande selon page / Esempio ordinazione vedi pagina 01.02.40/41

F.ST.UD48

Massstab 1:3 Version: P.Stacher 23.06.2017

ELKUCH EISENRING AG
Unterdorfstrasse 26
CH-9243 Jonschwil



06.20.50

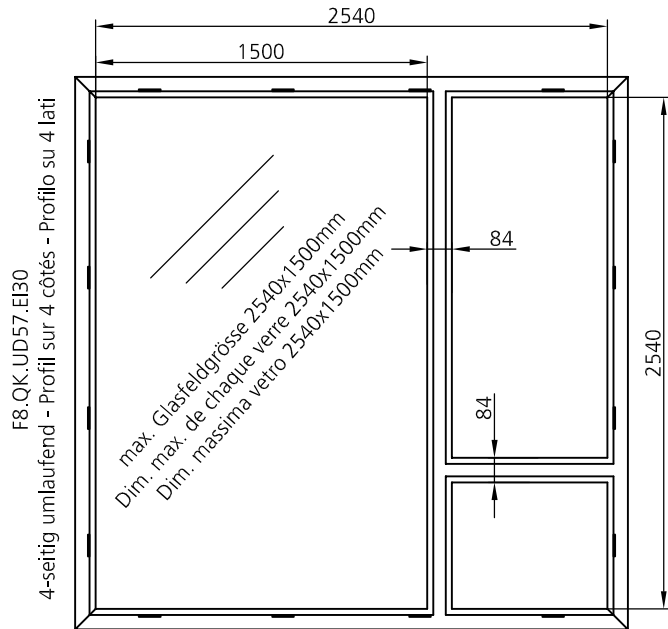

(Beispiel: mit Kämpfer und Pfosten)
(Exemple: avec montant et traverse)
(Esempio: con montante e traversa)

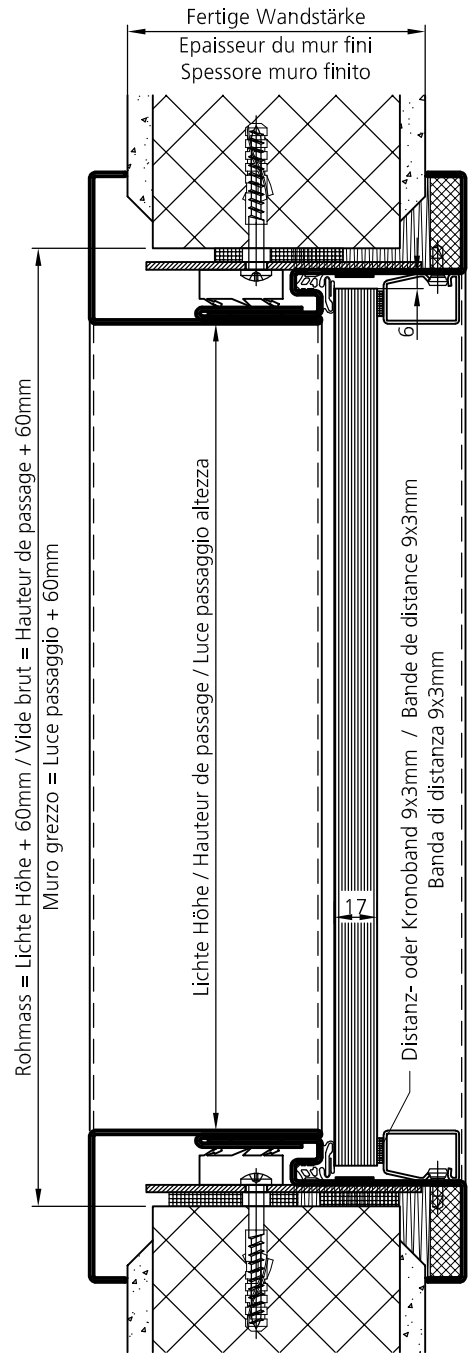
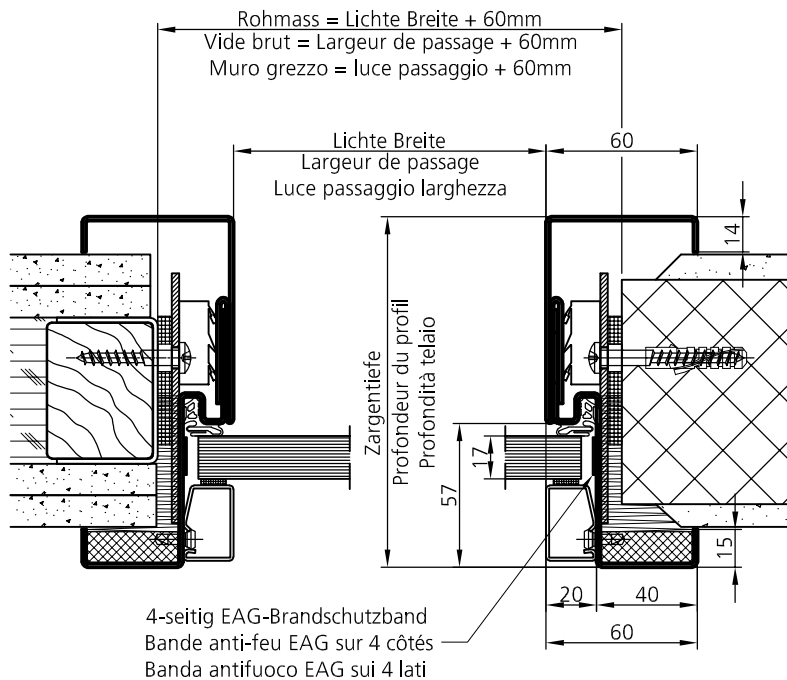

mit Jansen-Glasleisten 3020mm und Promaglas 30, Typ 1-0; Stärke 17mm
avec baguettes à verre Jansen 3020mm et verre Promaglas 30, type 1-0; épaisseur 17mm
ferma-vetri in Jansen 3020 e vetro Promaglas 30, tipo 1-0; spessore 17mm

Schreinerdetail Steckzargen / Détails de menuiserie pour huisserie en deux parties / Dettaglio telaio a baionetta per il falegname 09.05.01
EI30 = BS mit Steinwolle isolieren oder schäumen (bauseits) / EI30 = Cadre isolé avec laine de roche ou mousse (fournies par vos soins)
EI30 = Telaio isolare con lana di roccia o schiumare (a vostro carico)

Bestellbeispiel gemäss Seite / Exemple de commande selon page / Esempio ordinazione vedi pagina 01.02.40/41

F8.ST.UD57.EI30

Masstab Version: P.Stacher 23.06.2017

1:3

ELKUCH EISENRING AG
Unterdorfstrasse 26
CH-9243 Jonschwil

ELKUCH EISENRING

06.20.60

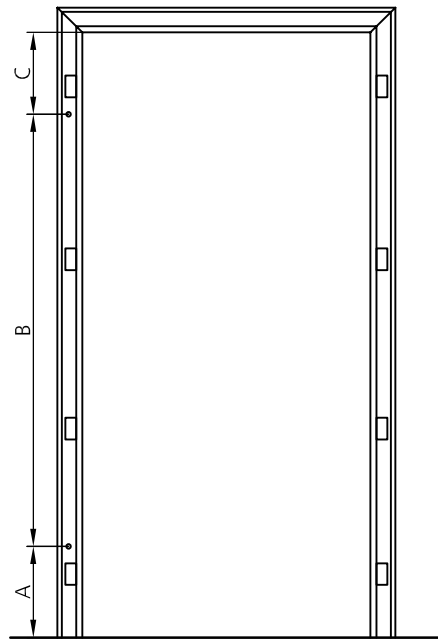

(Gezeichnet: Band links)
(Dessin: Fiche gauche)
(Disegnato: cerniere sx)

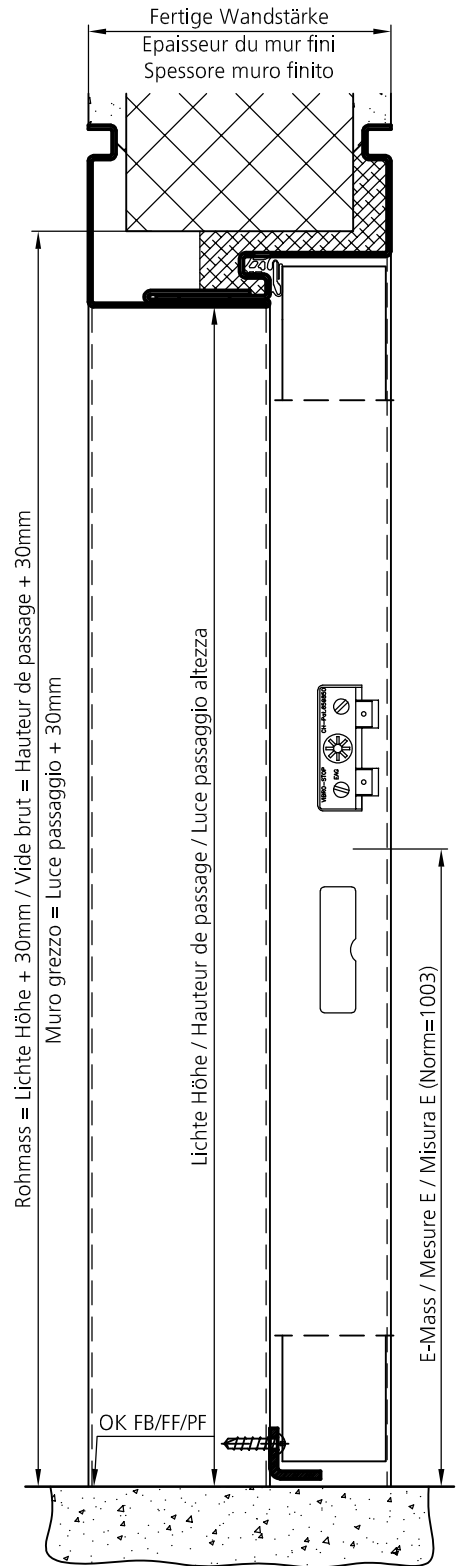
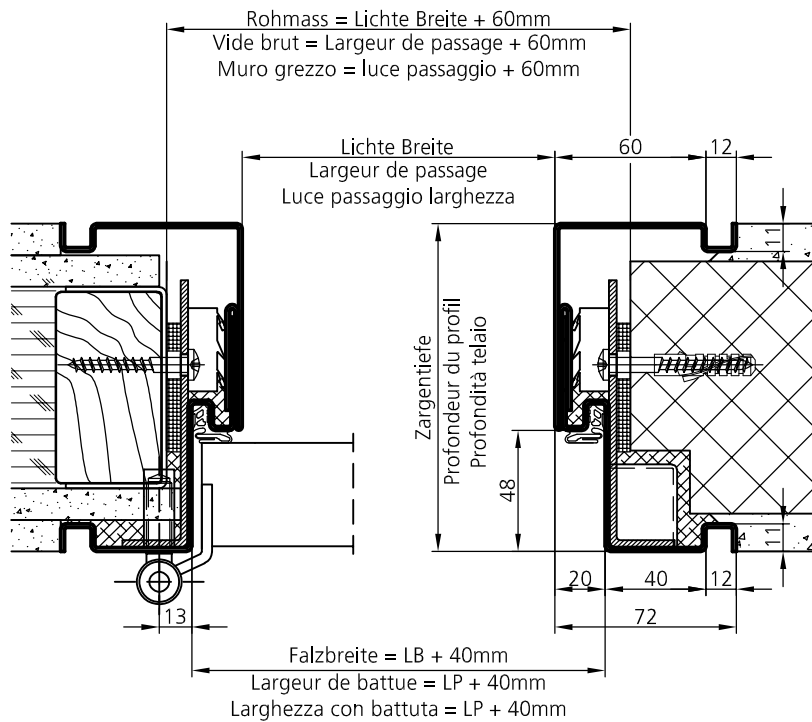

Schreinerdetail Steckzargen / Détails de menuiserie pour huisserie en deux parties / Dettaglio telai a baionetta per il falegname 09.05.01
EI30 = BS mit Steinwolle isolieren oder schäumen (bauseits) / EI30 = Cadre isolé avec laine de roche ou mousse (fournies par vos soins)
EI30 = Telaio isolare con lana di roccia o schiumare (a vostro carico)
Bestellbeispiel gemäss Seite / Exemple de commande selon page / Esempio ordinazione vedi pagina 01.02.40/41

NST.UDS

Masstab

Version:

P.Stacher

23.06.2017

1:3

ELKUCH EISENRING AG
Unterdorfstrasse 26
CH-9243 Jonschwil



06.21.01

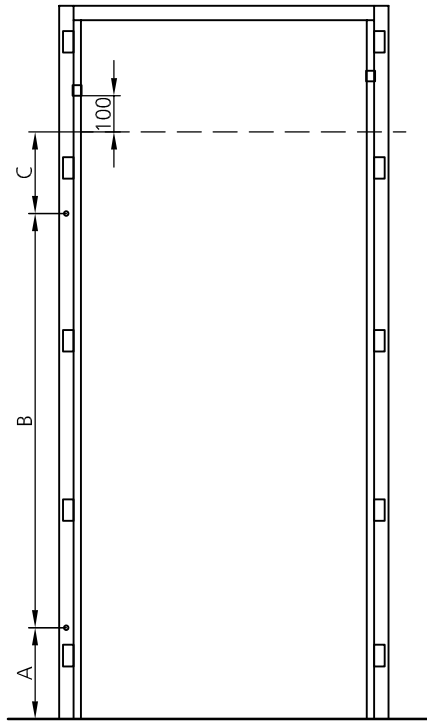

(Gezeichnet: Band links)
 (Dessin: Fiche gauche)
 (Disegnato: cerniere sx)

Detail: Blendenbefestigung
 Détail: fixation attique
 Dettaglio: fissaggio del sopraluce

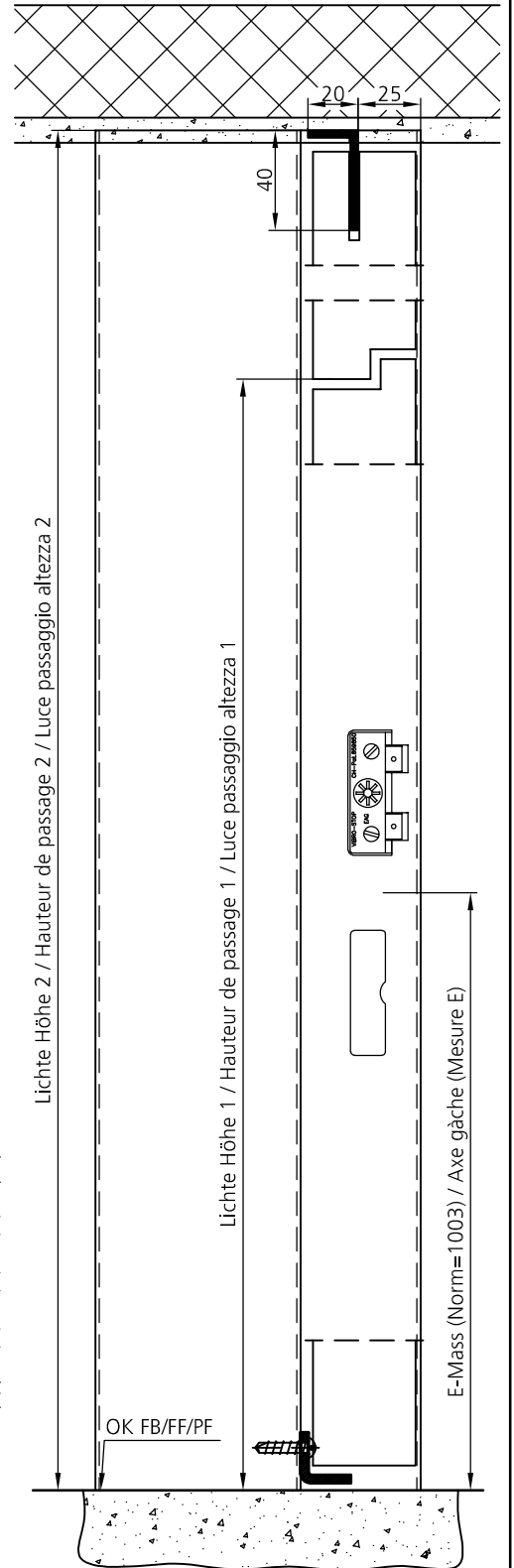
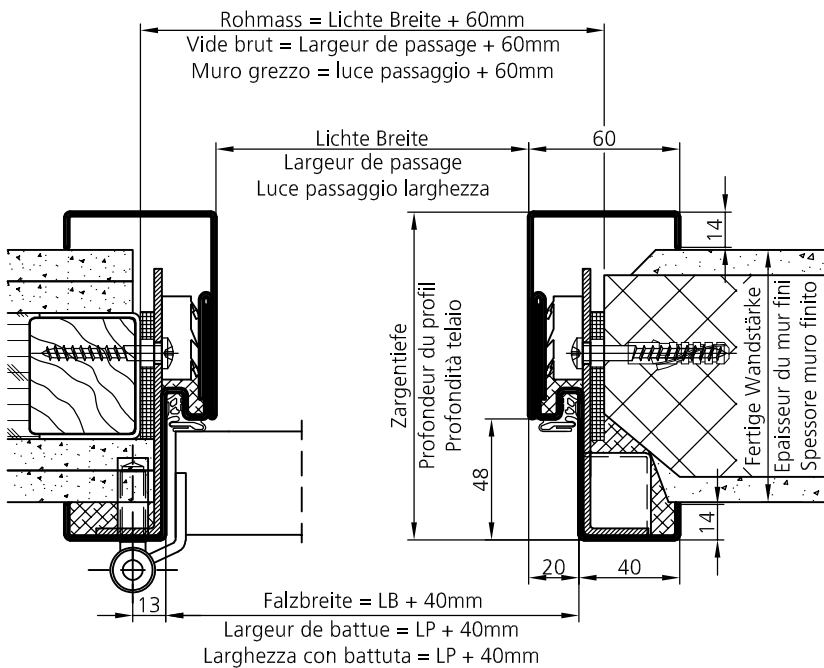
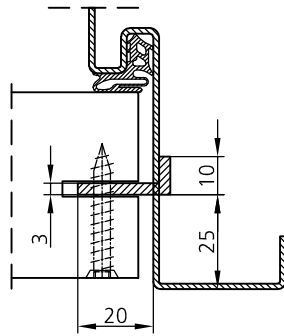

Schreinerdetail Steckzargen / Détails de menuiserie pour huisserie en deux parties / Dettaglio telaio a baionetta per il falegname 09.05.01
 EI30 = BS mit Steinwolle isolieren oder schäumen (bauseits) / EI30 = Cadre isolé avec laine de roche ou mousse (fournies par vos soins)
 EI30 = Telaio isolare con lana di roccia o schiumare (a vostro carico)
 Bestellbeispiel gemäss Seite / Exemple de commande selon page / Esempio ordinazione vedi pagina 01.02.40/41

H4.ST.UDS

Massstab Version: P.Stacher 23.06.2017

1:3

ELKUCH EISENRING AG
 Unterdorfstrasse 26
 CH-9243 Jonschwil



06.22.01

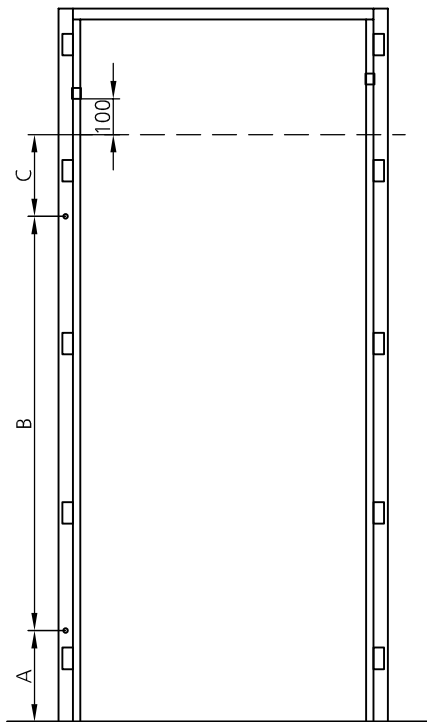

(Gezeichnet: Band links)
(Dessin: Fiche gauche)
(Disegnato: cerniere sx)

Detail: Blendenbefestigung
Détail: fixation attique
Dettaglio: fissaggio del sopra luce

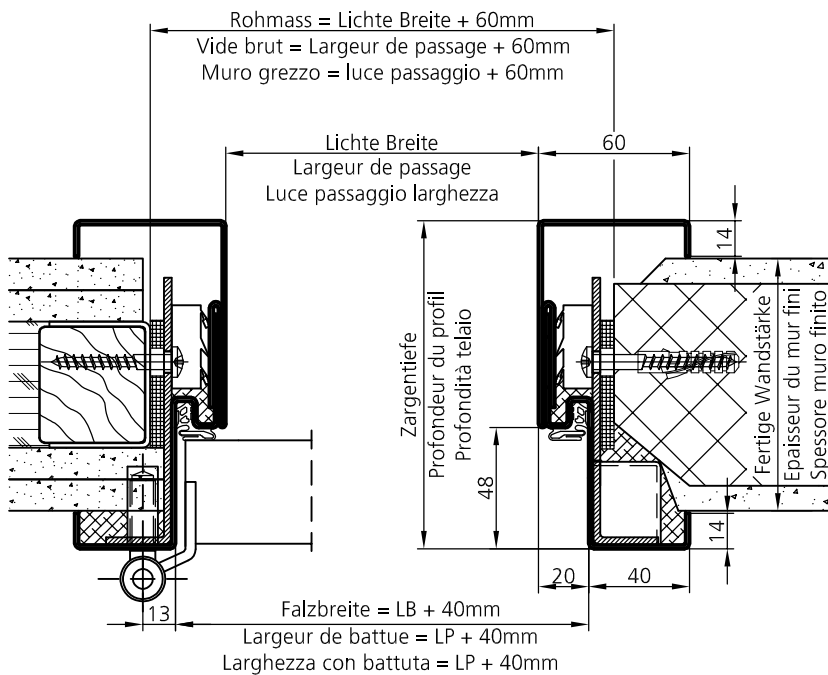
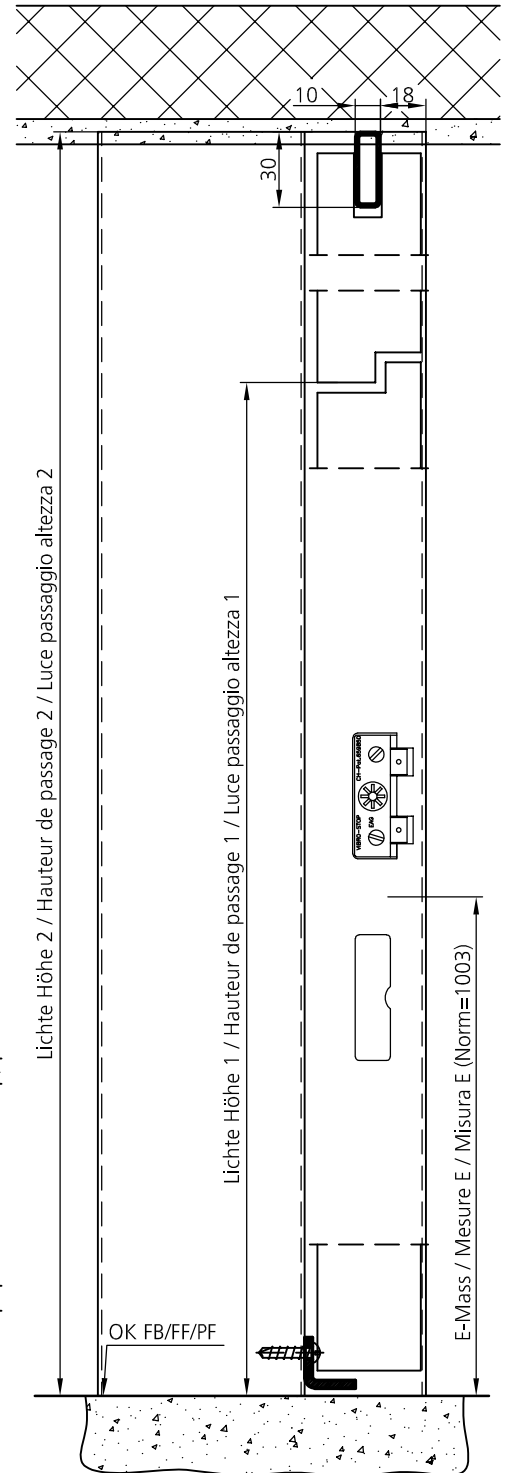
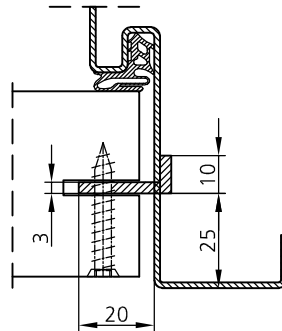

Schreinerdetail Steckzargen / Détails de menuiserie pour huisserie en deux parties / Dettaglio telaio a baionetta per il falegname 09.05.01
EI30 = BS mit Steinwolle isolieren oder schäumen (bauseits) / EI30 = Cadre isolé avec laine de roche ou mousse (fournies par vos soins)
EI30 = Telaio isolare con lana di roccia o schiumare (a vostro carico)
Bestellbeispiel gemäss Seite / Exemple de commande selon page / Esempio ordinazione vedi pagina 01.02.40/41

H6.ST.UDS

Massstab Version: P.Stacher 23.06.2017

1:3

ELKUCH EISENRING AG
Unterdorfstrasse 26
CH-9243 Jonschwil



06.22.50

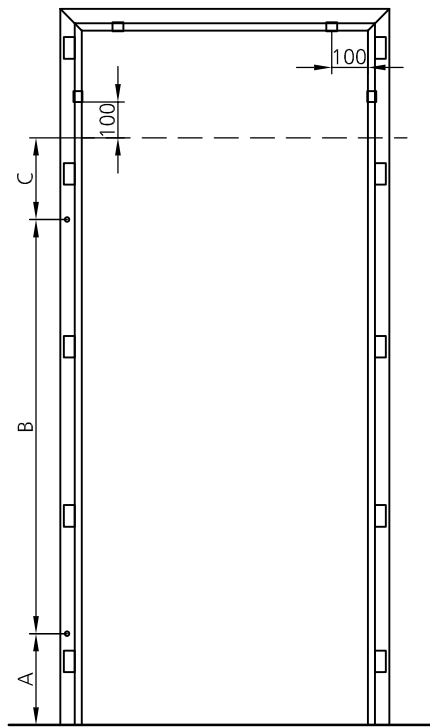

Detail: Blendenbefestigung
 Détail: fixation attique
 Dettaglio: fissaggio del sopraluce

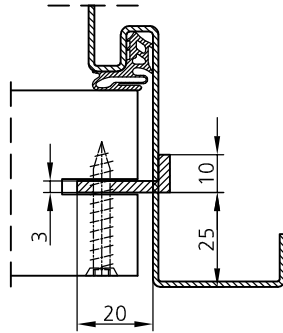

(Gezeichnet: Band links)
 (Dessin: Fiche gauche)
 (Disegnato: cerniere sx)

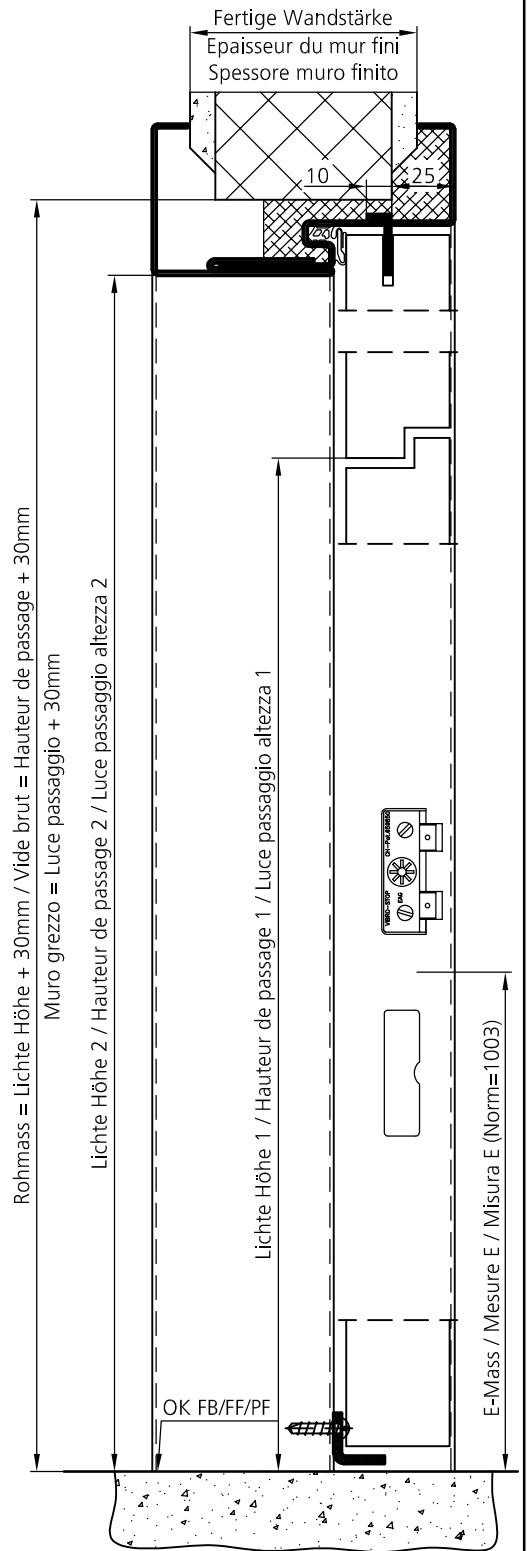
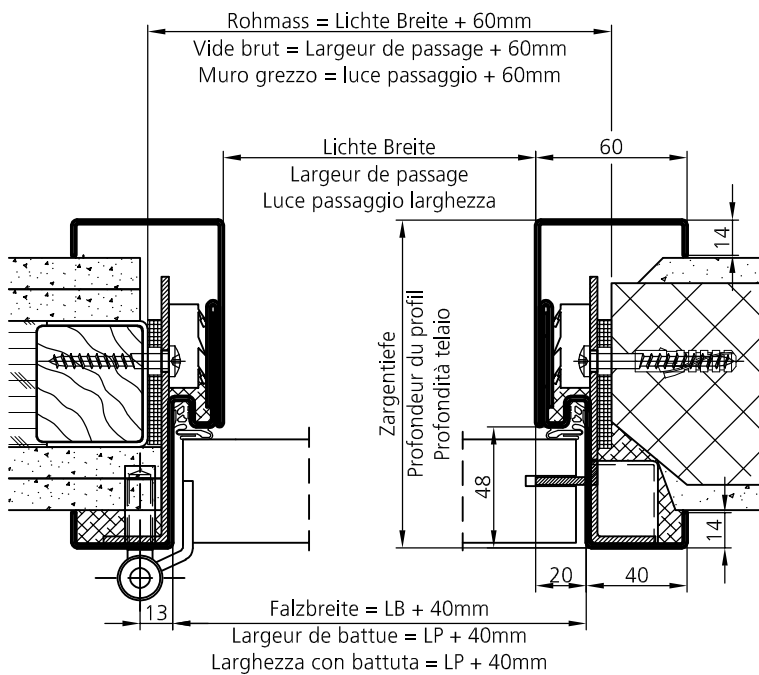

Schreinerdetail Steckzargen / Détails de menuiserie pour huisserie en deux parties / Dettaglio telaio a baionetta per il falegname 09.05.01
 EI30 = BS mit Steinwolle isolieren oder schäumen (bauseits) / EI30 = Cadre isolé avec laine de roche ou mousse (fournies par vos soins)
 EI30 = Telaio isolare con lana di roccia o schiumare (a vostro carico)
 Bestellbeispiel gemäss Seite / Exemple de commande selon page / Esempio ordinazione vedi pagina 01.02.40/41

B.ST.UDS

Massstab Version: P.Stacher 23.06.2017

1:3

ELKUCH EISENRING AG
 Unterdorfstrasse 26
 CH-9243 Jonschwil



06.23.01

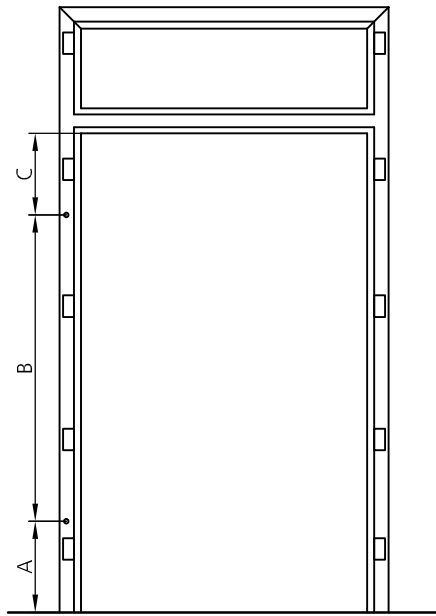

(Gezeichnet: Band links)
(Dessin: Fiche gauche)
(Disegnato: cerniere sx)

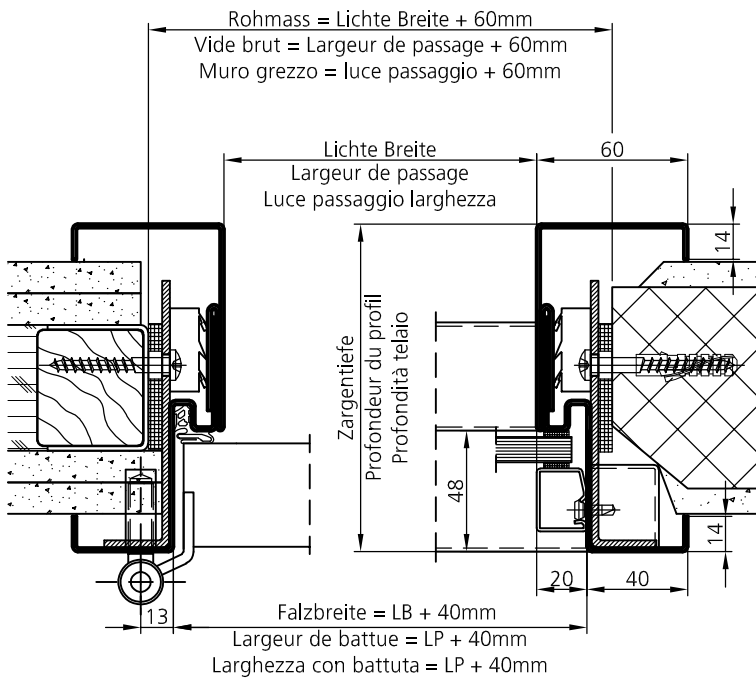

mit Jansen-Glasleisten
avec baguettes à verre Jansen
ferma-vetri in Jansen

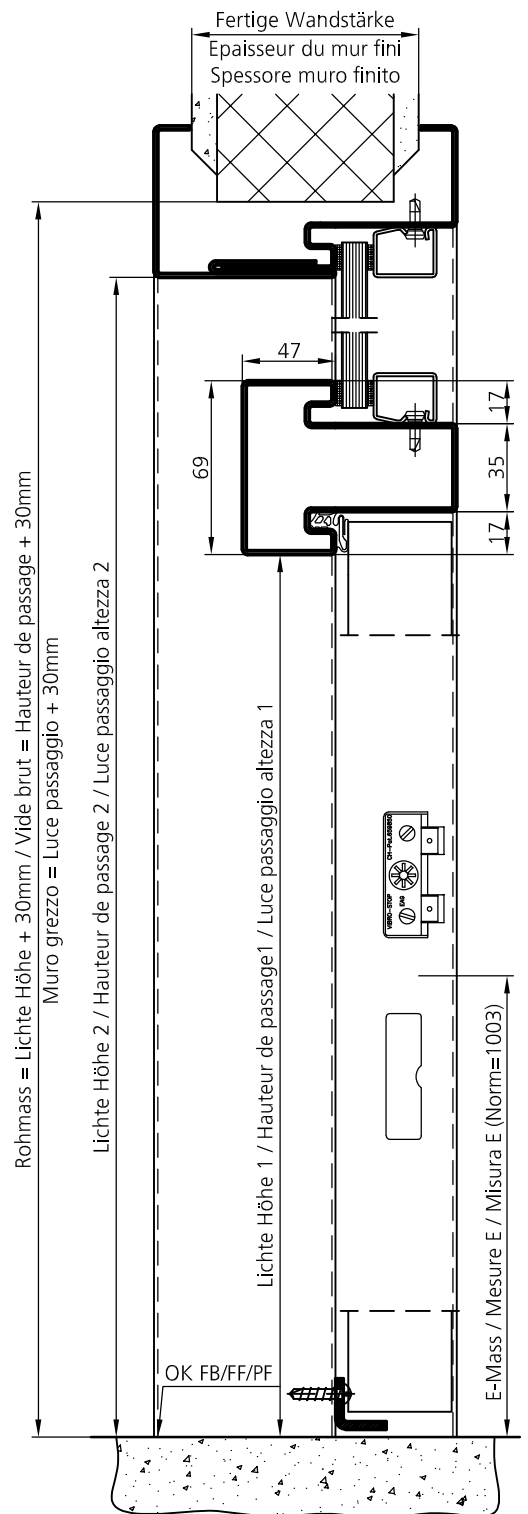

Schreinerdetail Steckzargen / Détails de menuiserie pour huisserie en deux parties / Dettaglio telai a baionetta per il falegname 09.05.01
Bestellbeispiel gemäss Seite / Exemple de commande selon page / Esempio ordinazione vedi pagina 01.02.40/41

K4.ST.UDS

Masstab Version: P.Stacher 23.06.2017

1:3

ELKUCH EISENRING AG
Unterdorfstrasse 26
CH-9243 Jonschwil

ELKUCH EISENRING

06.24.01

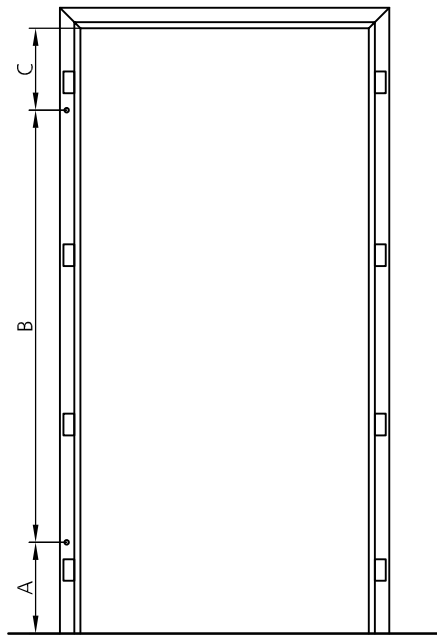

(Gezeichnet: Band links)
 (Dessin: Fiche gauche)
 (Disegnato: cerniere sx)

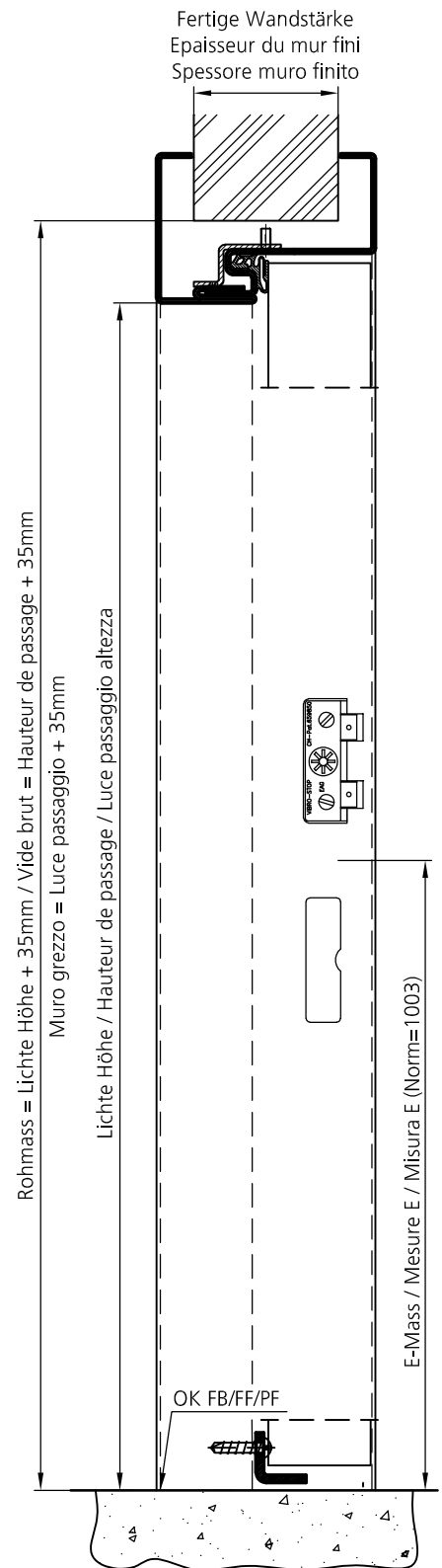
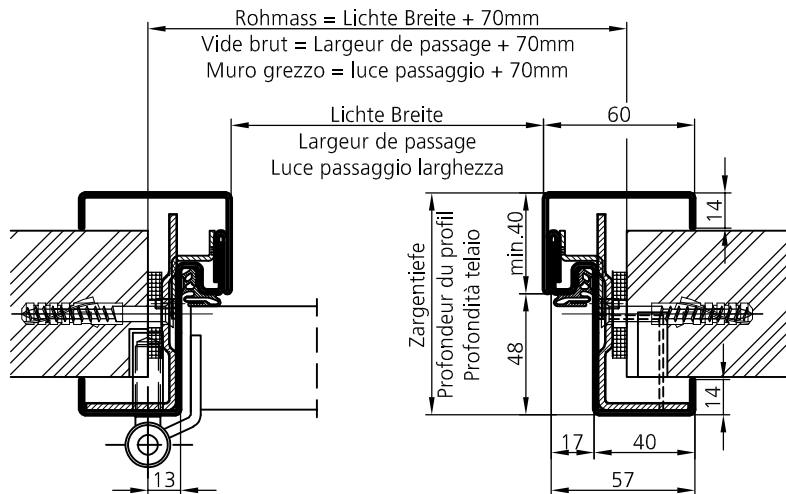

EI30 = BS mit Steinwolle isolieren (bauseits) / Cadre isolé avec laine de roche (par vos soins) / Telaio isolare con lana di roccia (a vostro carico)
 Bestellbeispiel gemäss Seite / Exemple de commande selon page / Esempio ordinazione vedi pagina 01.02.40/41

ST1.UDS

Masstab

Version:

P. Stacher

23.06.2017

1:3

ELKUCH EISENRING AG
 Unterdorfstrasse 26
 CH-9243 Jonschwil



06.25.01

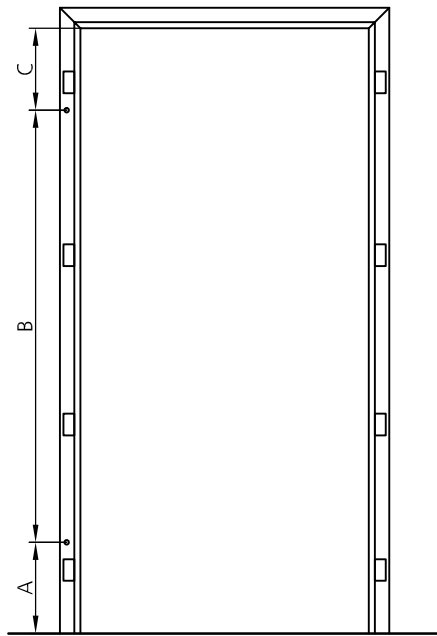

(Gezeichnet: Band links)
 (Dessin: Fiche gauche)
 (Disegnato: cerniere sx)

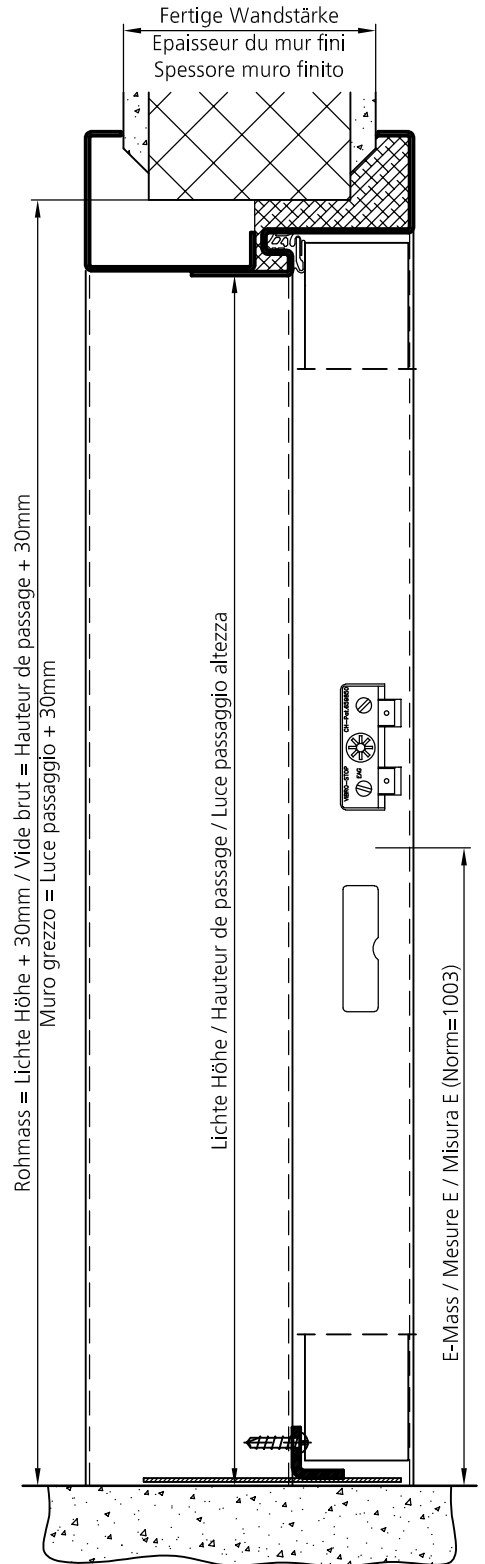
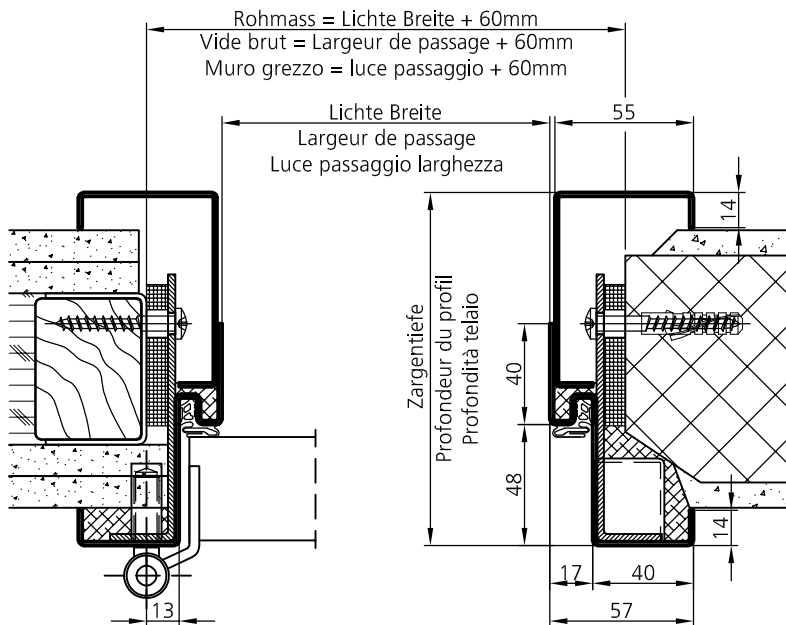

Schreinerdetail Steckzargen / Détails de menuiserie pour huisserie en deux parties / Dettaglio telai a baionetta per il falegname 09.05.01
 EI30 = BS mit Steinwolle isolieren oder schäumen (bauseits) / EI30 = Cadre isolé avec laine de roche ou mousse (fournies par vos soins)
 EI30 = Telaio isolare con lana di roccia o schiumare (a vostro carico)
 Bestellbeispiel gemäss Seite / Exemple de commande selon page / Esempio ordinazione vedi pagina 01.02.40/41

ST6.UDS

Masstab 1:3 Version: P.Stacher 23.06.2017

1:3

ELKUCH EISENRING AG
 Unterdorfstrasse 26
 CH-9243 Jonschwil



06.29.01

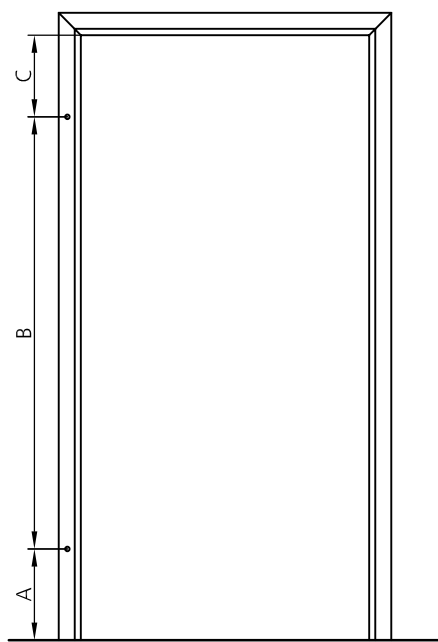

(Gezeichnet: Band links)
(Dessin: Fiche gauche)
(Disegnato: cerniere sx)

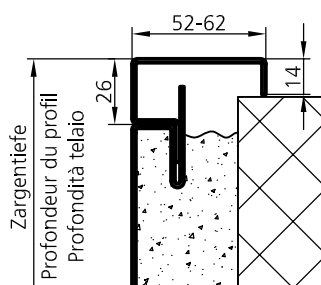

Variante: E1
(ST7.UDS.E1)

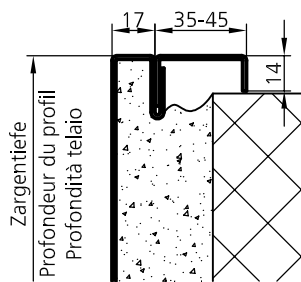

Variante: G1
(ST7.UDS.G1)

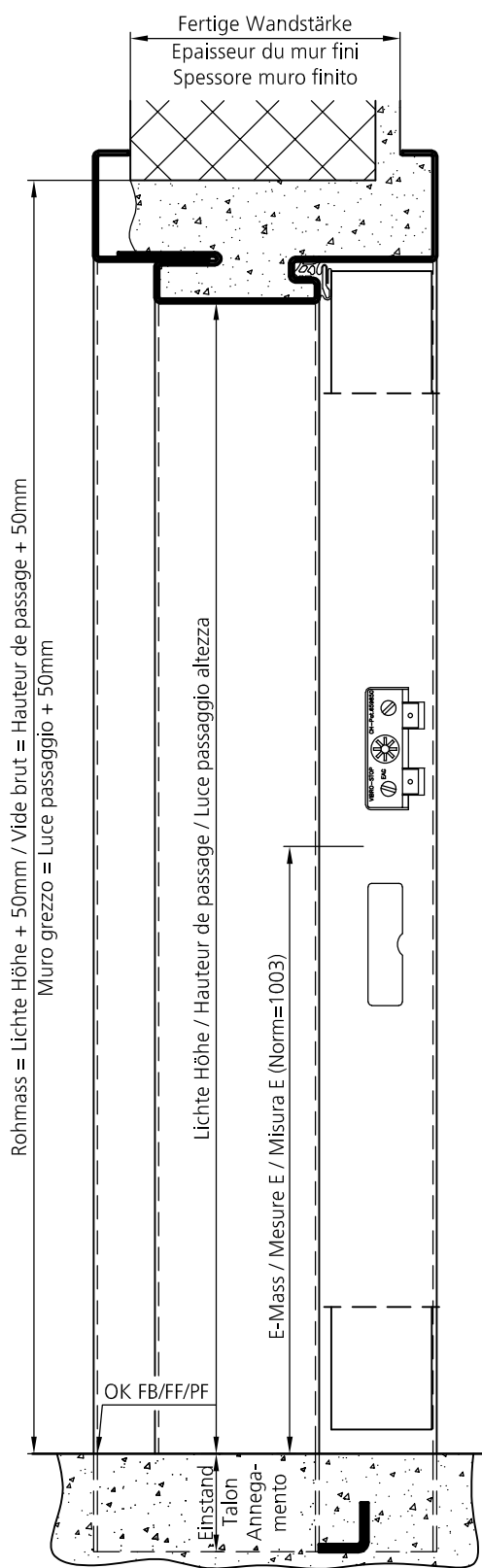
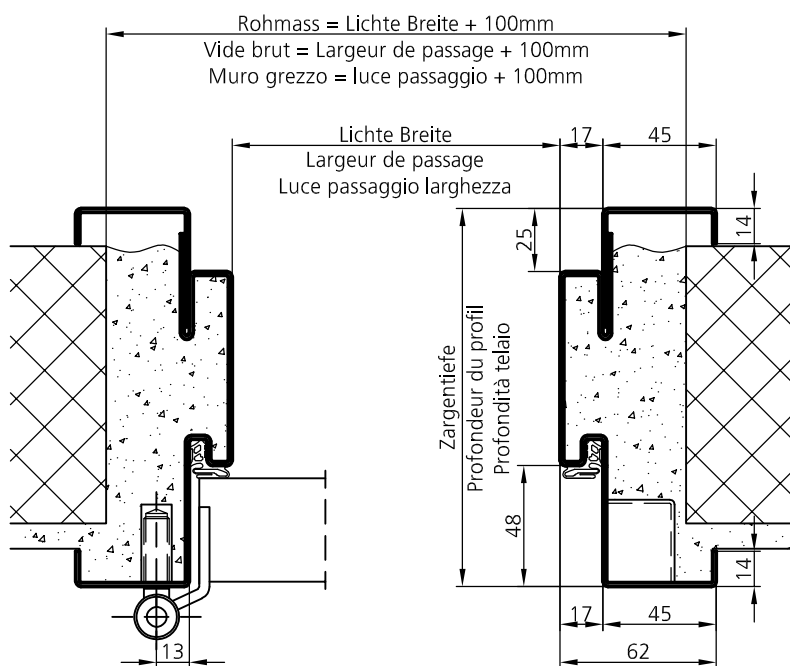

Bestellbeispiel gemäss Seite / Exemple de commande selon page / Esempio ordinazione vedi pagina 01.02.40/41

ST7.UDS

Masstab Version: P.Stacher 23.06.2017

1:3

ELKUCH EISENRING AG
Unterdorfstrasse 26
CH-9243 Jonschwil



06.30.01

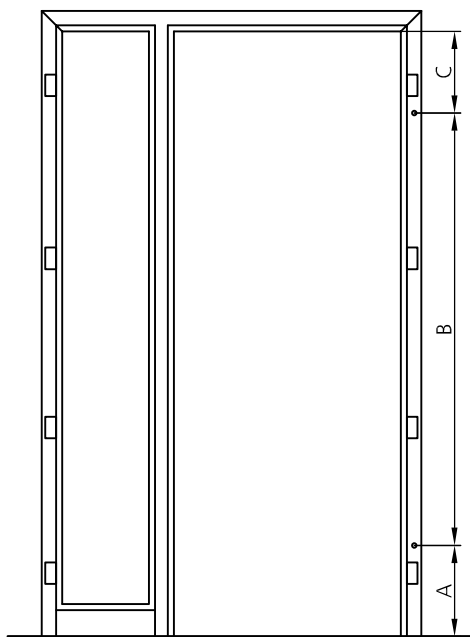

(Gezeichnet: Q1 = Glas links, Band rechts)
 (Dessin: Q1 = verre gauche, Fiche droite)
 (Disegnato: Q1 = vetri sinistra, cerniere sx)

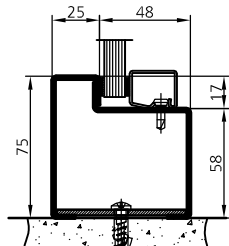

Sockel ohne Bodeneinstand
 Socle sans talon

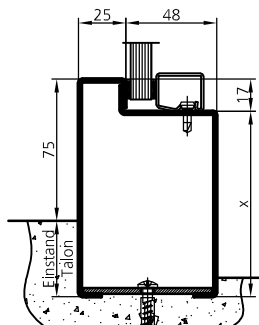

Sockel mit Bodeneinstand
 Socle avec talon

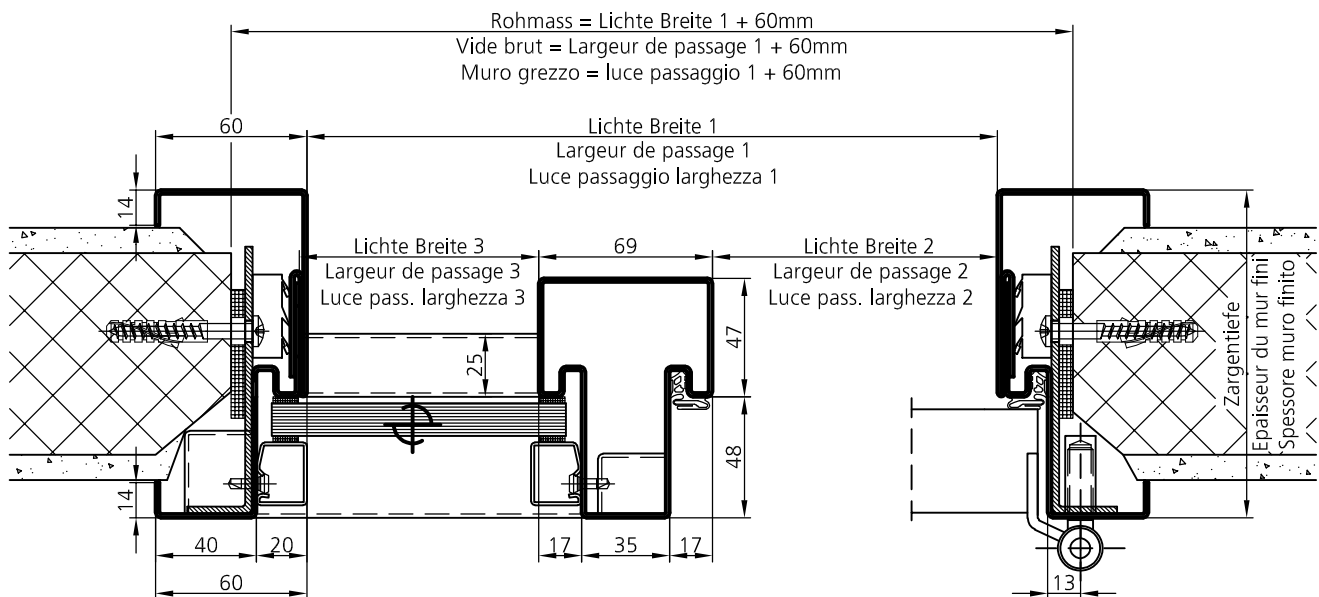
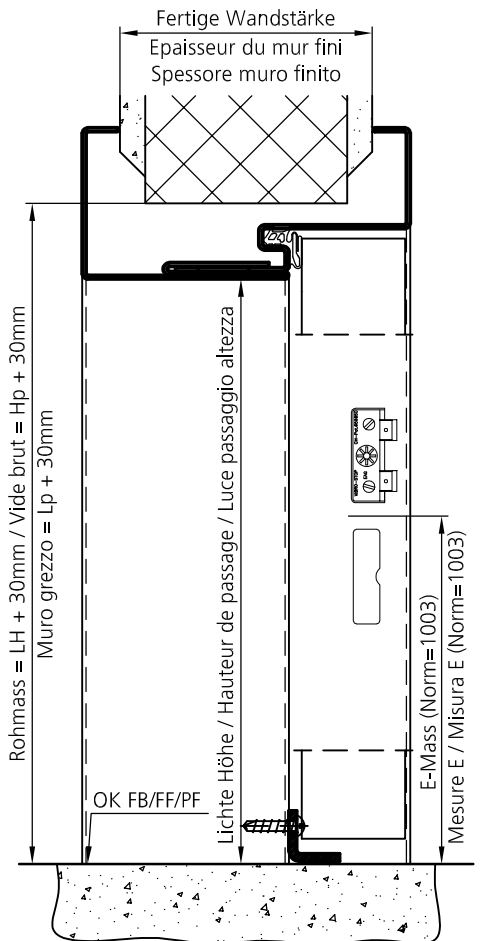

mit Alu- oder Jansen-Glasleisten
avec baguettes à verre Alu ou Jansen / ferma-vetri in alu o Jansen

Schreinerdetail Steckzargen / Détails de menuiserie pour huisserie en deux parties / Dettaglio telai a baionetta per il falegname 09.05.01
 Bestellbeispiel gemäss Seite / Exemple de commande selon page / Esempio ordinazione vedi pagina 01.02.40/41

Q1/2.ST.UDS

Masstab Version: P.Stacher 23.06.2017

1:3

ELKUCH EISENRING AG
 Unterdorfstrasse 26
 CH-9243 Jonschwil



06.35.01

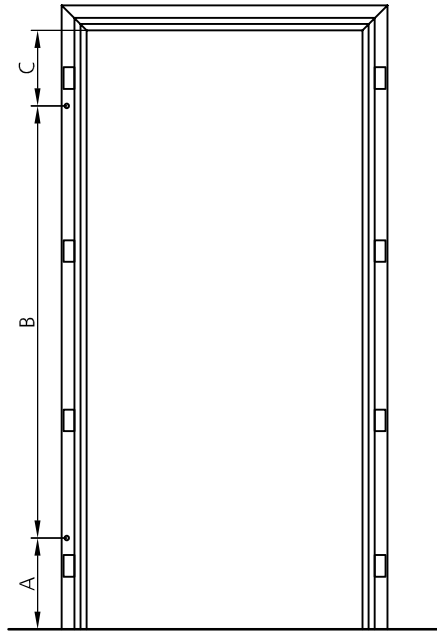

(Gezeichnet: Band links)
(Dessin: Fiche gauche)
(Disegnato: cerniere sx)

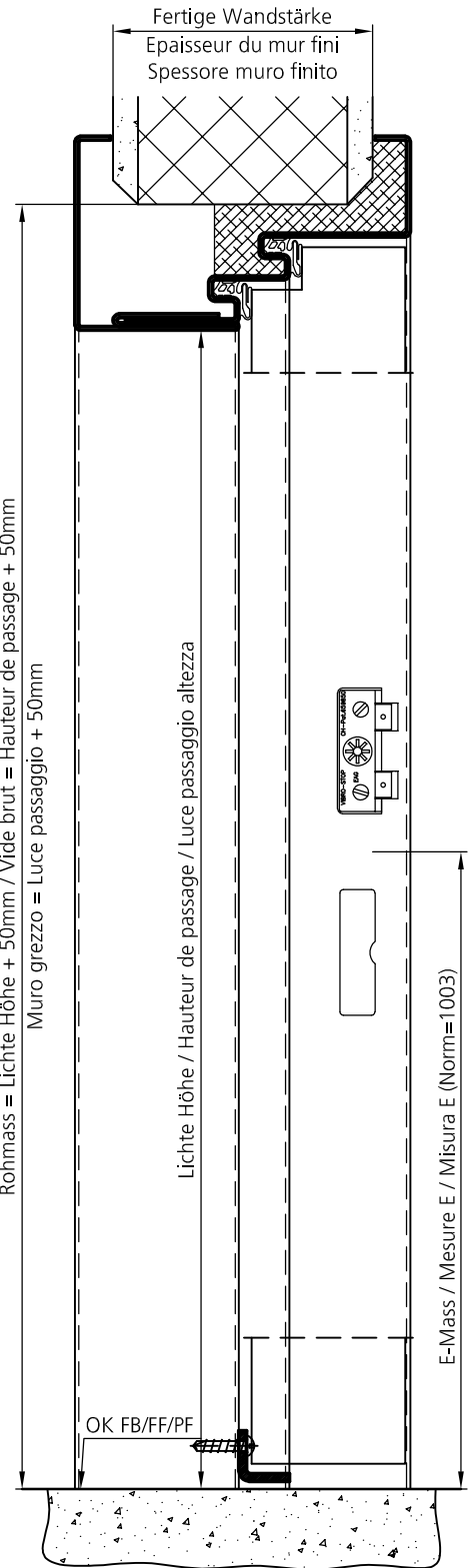
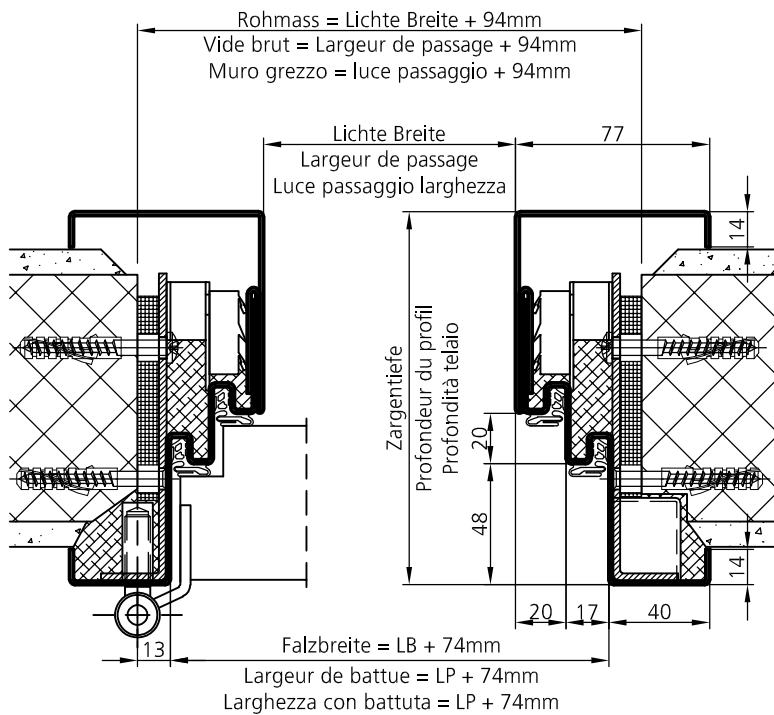

Schreinerdetail Steckzargen / Détails de menuiserie pour huisserie en deux parties / Dettaglio telai a baionetta per il falegname 09.05.01
EI30 = BS mit Steinwolle isolieren oder schäumen (bauseits) / EI30 = Cadre isolé avec laine de roche ou mousse (fournies par vos soins)
EI30 = Telaio isolare con lana di roccia o schiumare (a vostro carico)
Bestellbeispiel gemäss Seite / Exemple de commande selon page / Esempio ordinazione vedi pagina 01.02.40/41

ST.UDDS



Massstab Version: P.Stacher 23.06.2017

1:3

ELKUCH EISENRING AG
Unterdorfstrasse 26
CH-9243 Jonschwil

06.40.01

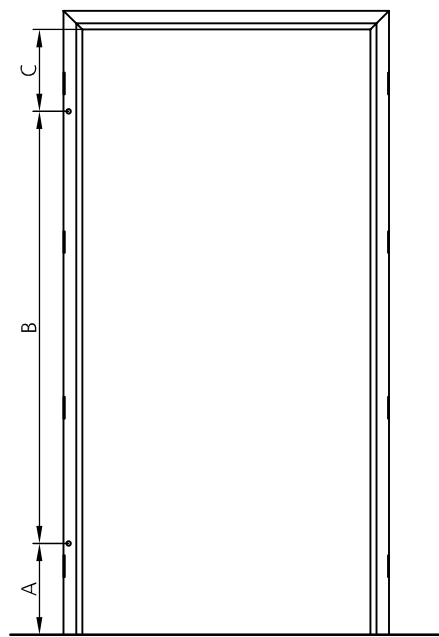

(Gezeichnet: Band links)
 (Dessin: Fiche gauche)
 (Disegnato: cerniere sx)

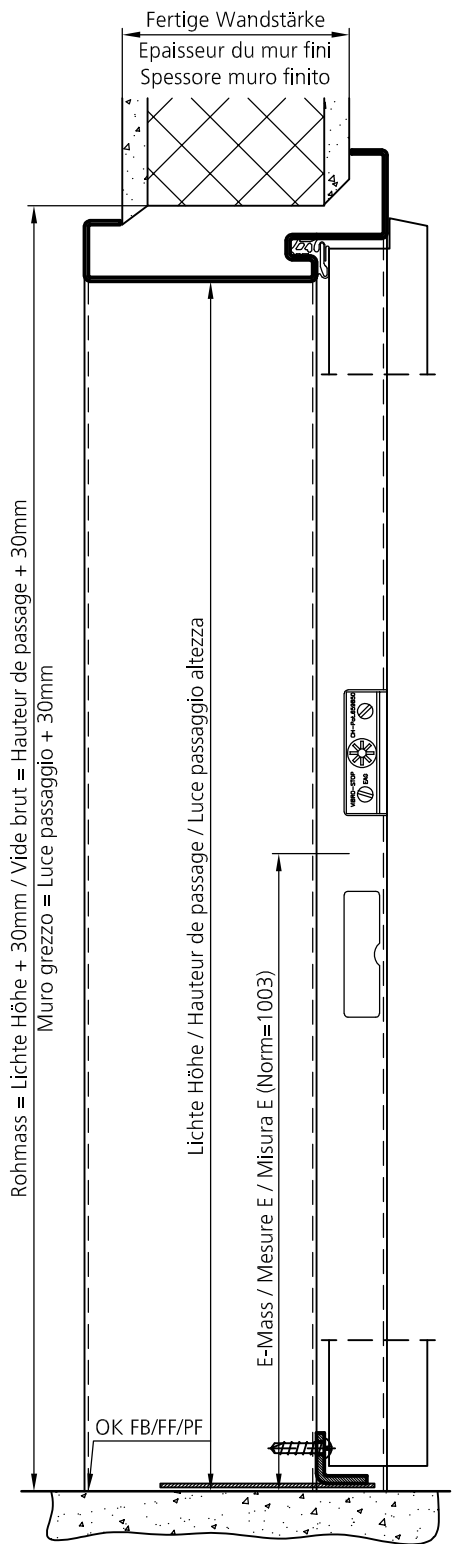
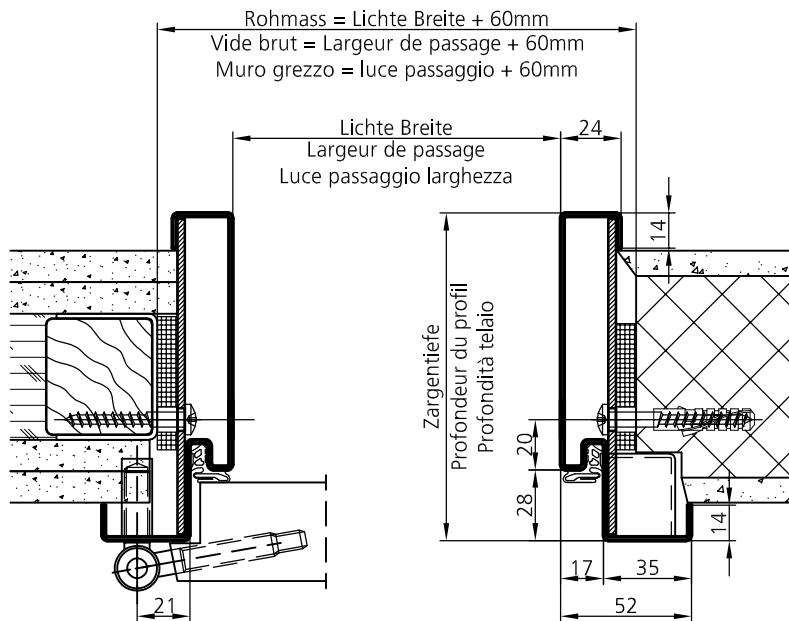

Bestellbeispiel gemäss Seite / Exemple de commande selon page / Esempio ordinazione vedi pagina 01.02.40/41

UD.TM

Masstab Version: P.Stacher 23.06.2017

1:3

ELKUCH EISENRING AG
 Unterdorfstrasse 26
 CH-9243 Jonschwil



06.80.01

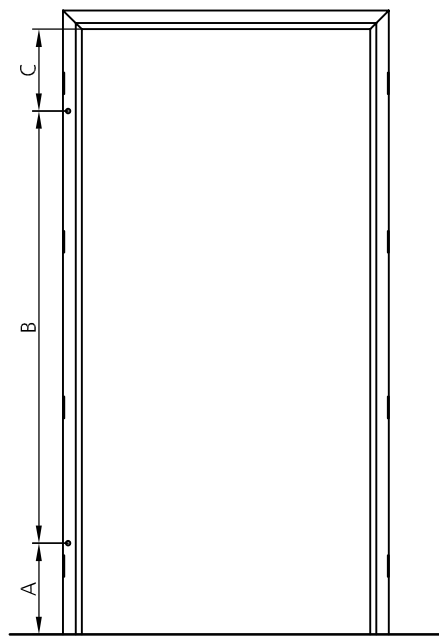

(Gezeichnet: Band links)
(Dessin: Fiche gauche)
(Disegnato: cerniere sx)

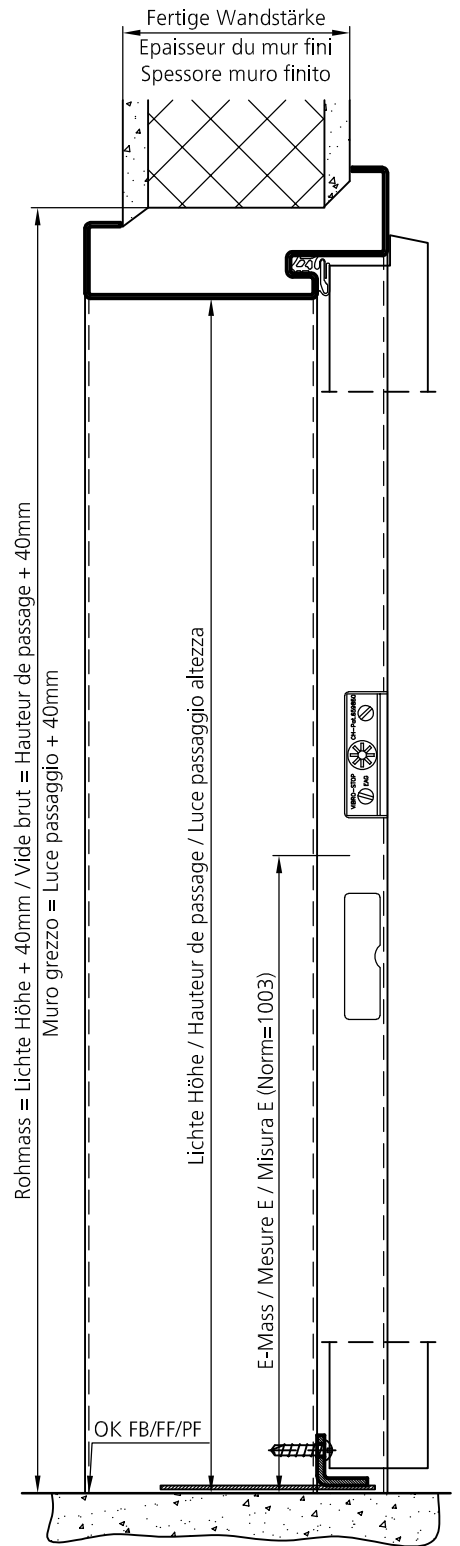
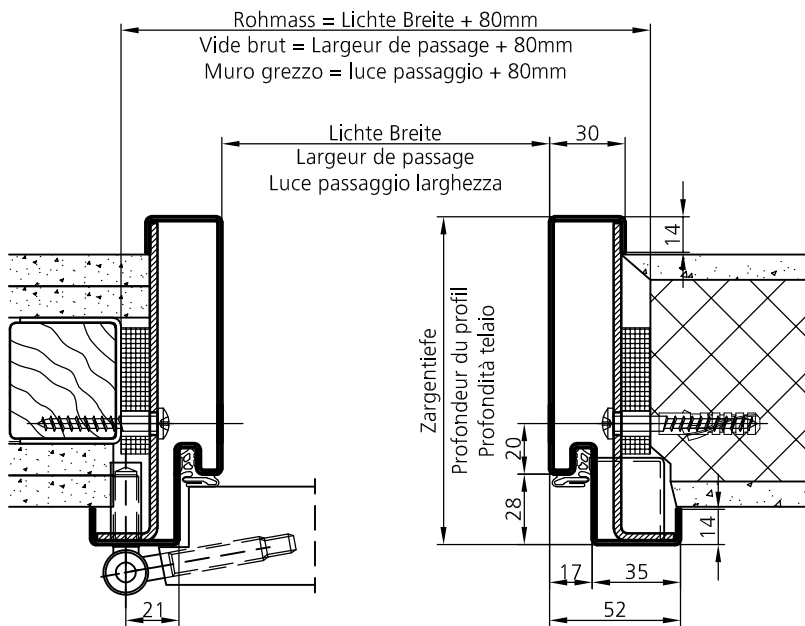

Bestellbeispiel gemäss Seite / Exemple de commande selon page / Esempio ordinazione vedi pagina 01.02.40/41

UD.TM.S

Masstab

Version:

P.Stacher

23.06.2017

1:3

ELKUCH EISENRING AG
Unterdorfstrasse 26
CH-9243 Jonschwil



06.80.10

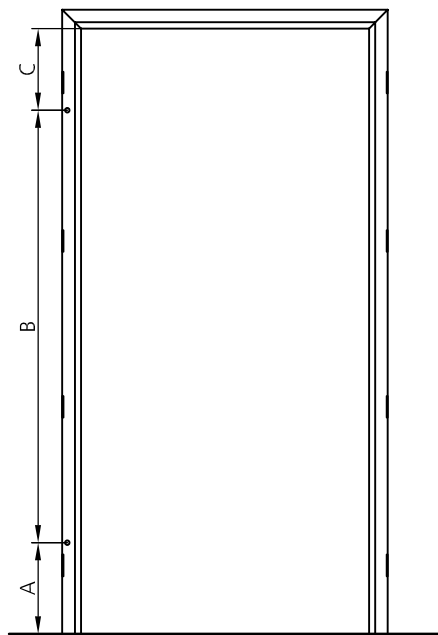

(Gezeichnet: Band links)
(Dessin: Fiche gauche)
(Disegnato: cerniere sx)

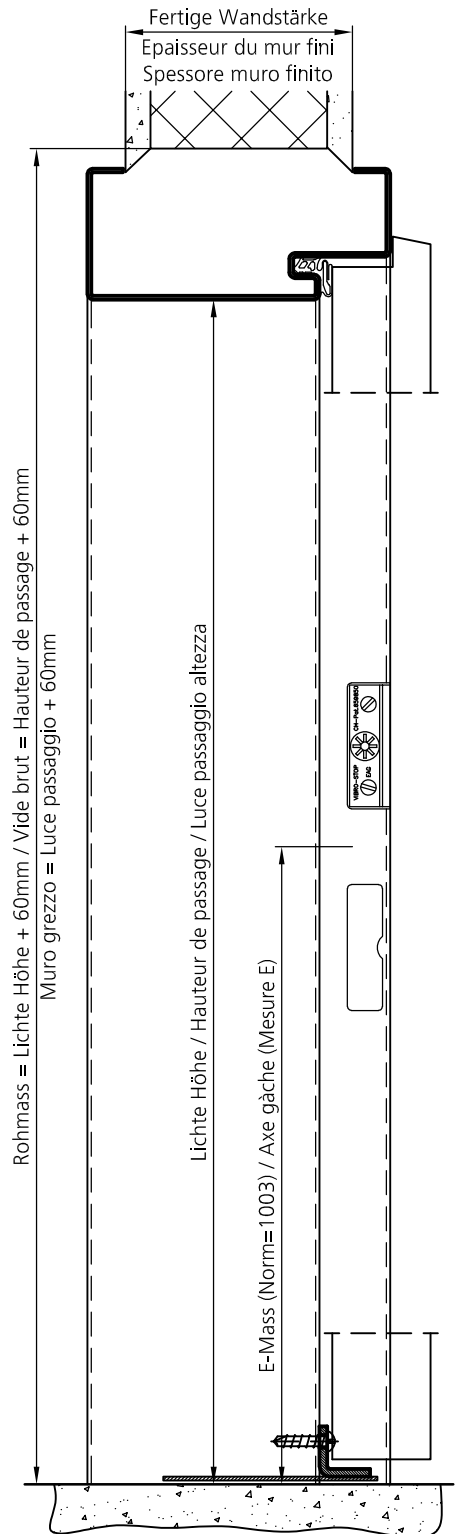
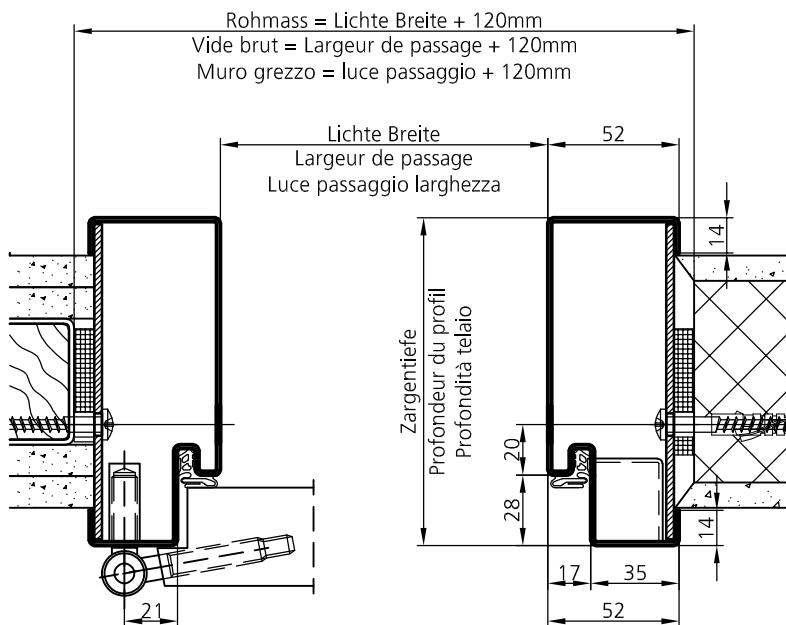

Bestellbeispiel gemäss Seite / Exemple de commande selon page / Esempio ordinazione vedi pagina 01.02.40/41

W.UD.TM

Masstab

Version:

P.Stacher

23.06.2017

1:3

ELKUCH EISENRING AG
Unterdorfstrasse 26
CH-9243 Jonschwil



06.80.20

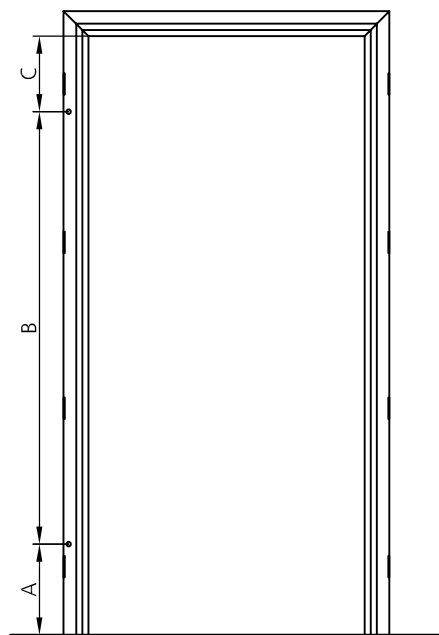

(Gezeichnet: Band links)
(Dessin: Fiche gauche)
(Disegnato: cerniere sx)

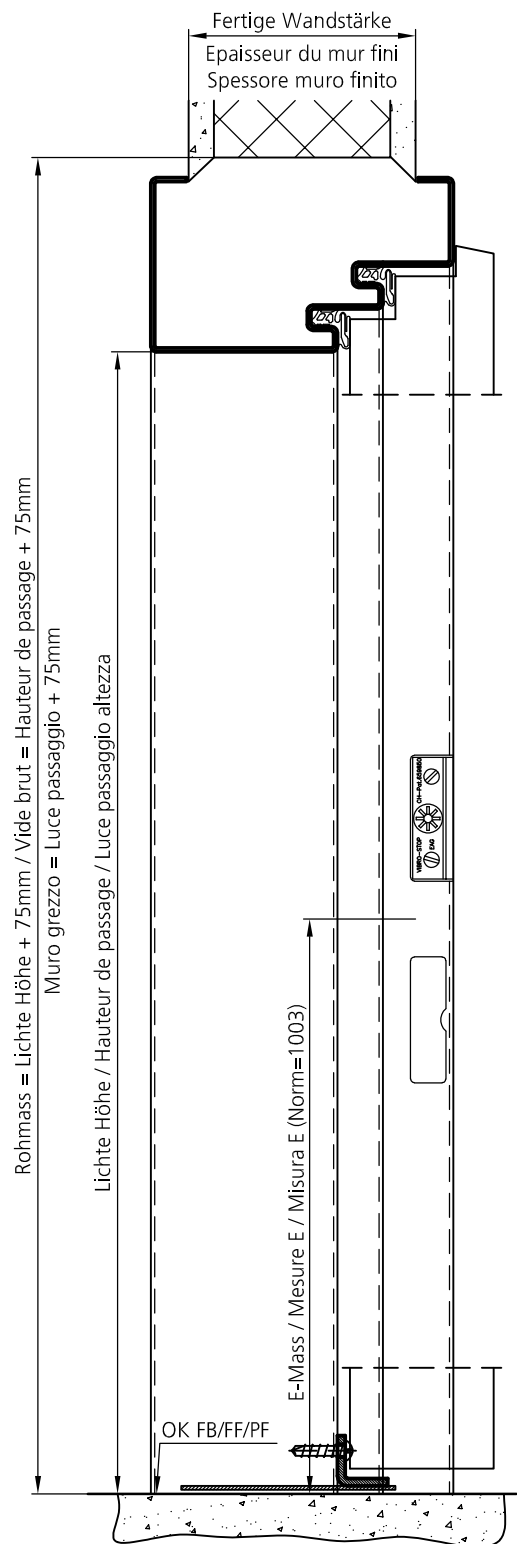
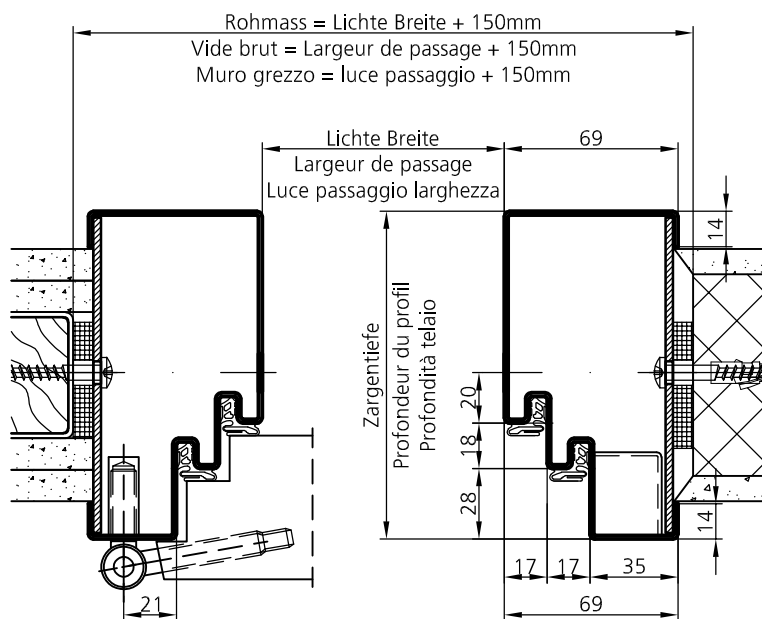

Bestellbeispiel gemäss Seite / Exemple de commande selon page / Esempio ordinazione vedi pagina 01.02.40/41

W.UDD.TM

Masstab

Version:

P.Stacher

23.06.2017

1:3

ELKUCH EISENRING AG
Unterdorfstrasse 26
CH-9243 Jonschwil



06.82.20

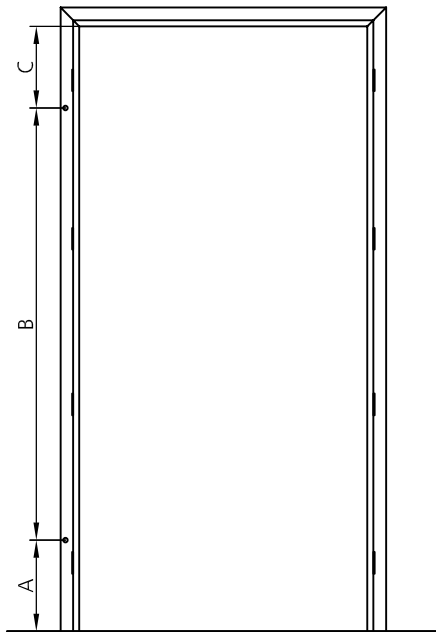

(Gezeichnet: Band links)
(Dessin: Fiche gauche)
(Disegnato: cerniere sx)

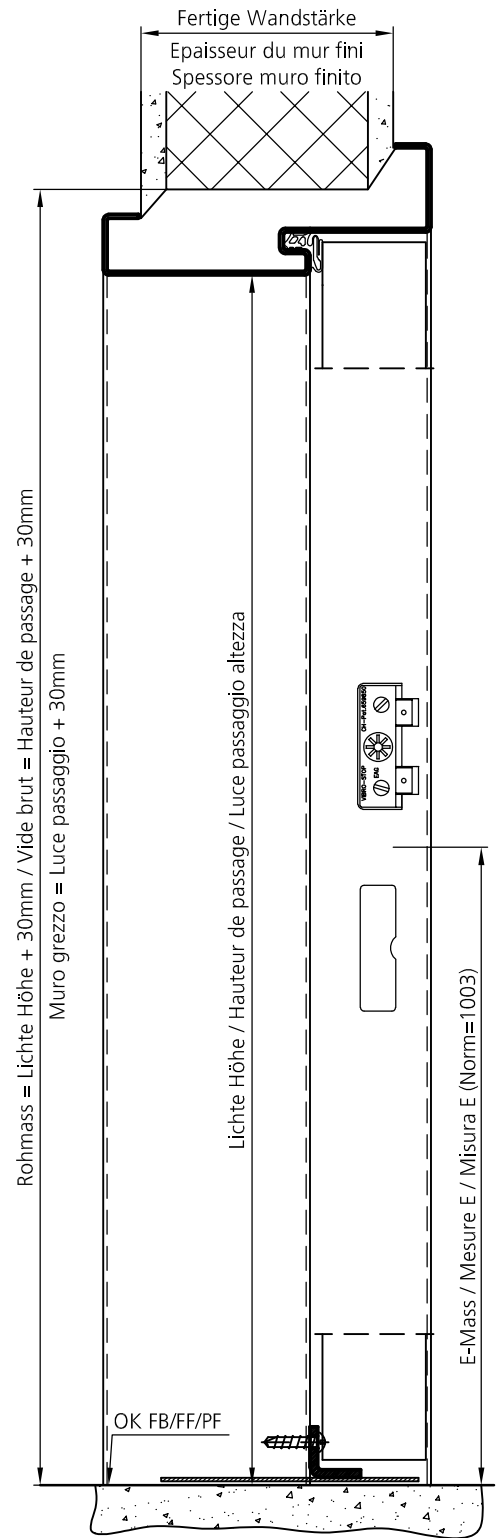
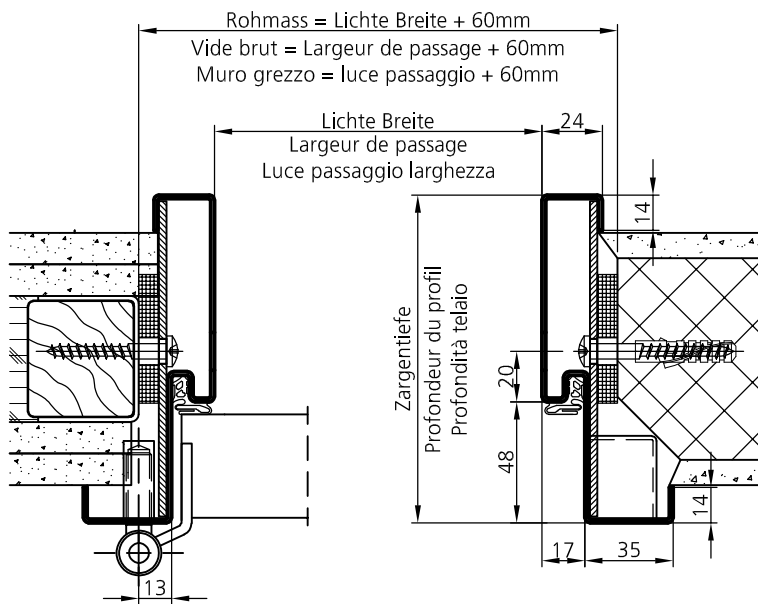

Bestellbeispiel gemäss Seite / Exemple de commande selon page / Esempio ordinazione vedi pagina 01.02.40/41

UDS.TM

Masstab Version: P.Stacher 23.06.2017

1:3

ELKUCH EISENRING AG
Unterdorfstrasse 26
CH-9243 Jonschwil



06.84.01

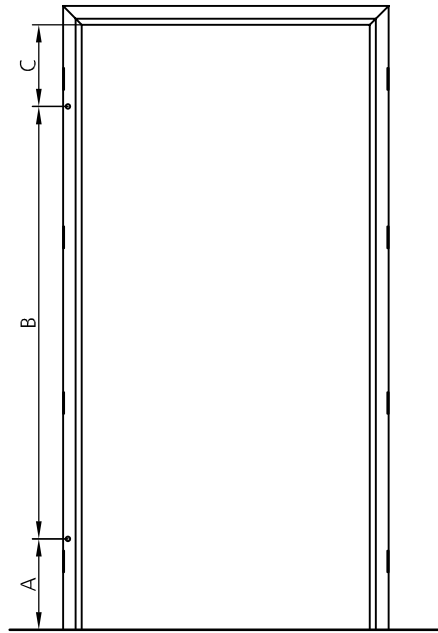

(Gezeichnet: Band links)
(Dessin: Fiche gauche)
(Disegnato: cerniere sx)

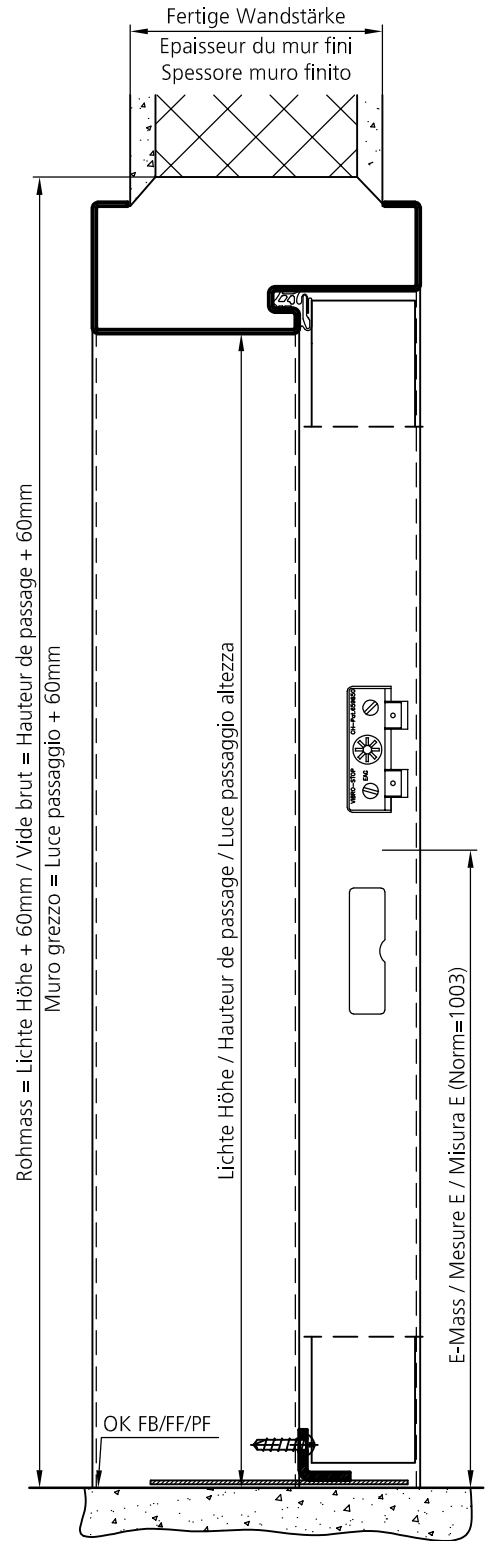
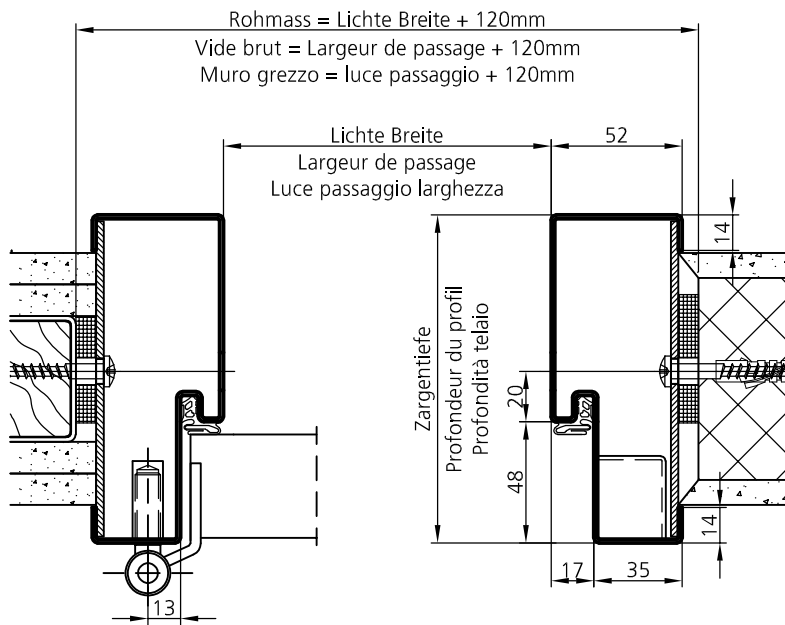

Bestellbeispiel gemäss Seite / Exemple de commande selon page / Esempio ordinazione vedi pagina 01.02.40/41

W.UDS.TM

Masstab 1:3 Version: P.Stacher 23.06.2017

ELKUCH EISENRING AG
Unterdorfstrasse 26
CH-9243 Jonschwil



06.84.20

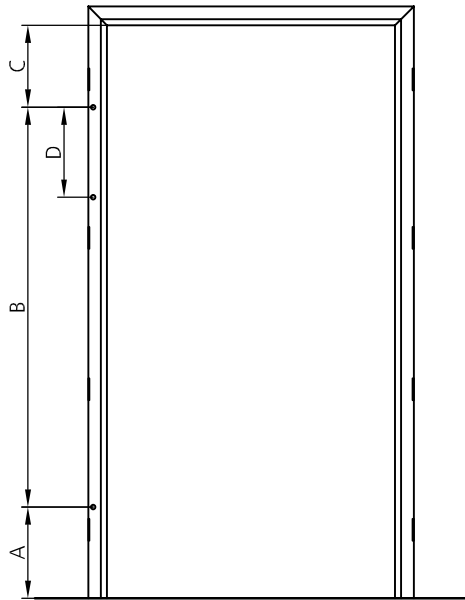

(Gezeichnet: Band links)
 (Dessin: Fiche gauche)
 (Disegnato: cerniere sx)

Wandanschluss 3-seitig: durchgehend isoliert,
 oder Steinwollzopf 2x (li+re)
 Raccordement au mur sur 3 côtés: isolé en continu
 ou cordon de laine de roche 2x (drt+gch)
 Raccordo al muro isolato continuo o cordone di
 lana di roccia 2x (dx+sx)

Bügelanordnung + Montage analog L4.EI30-Rahmen
Position des pattes + montage similaire au cadre L4.EI30
Posizione della staffa + montaggio come telaio L4.EI30

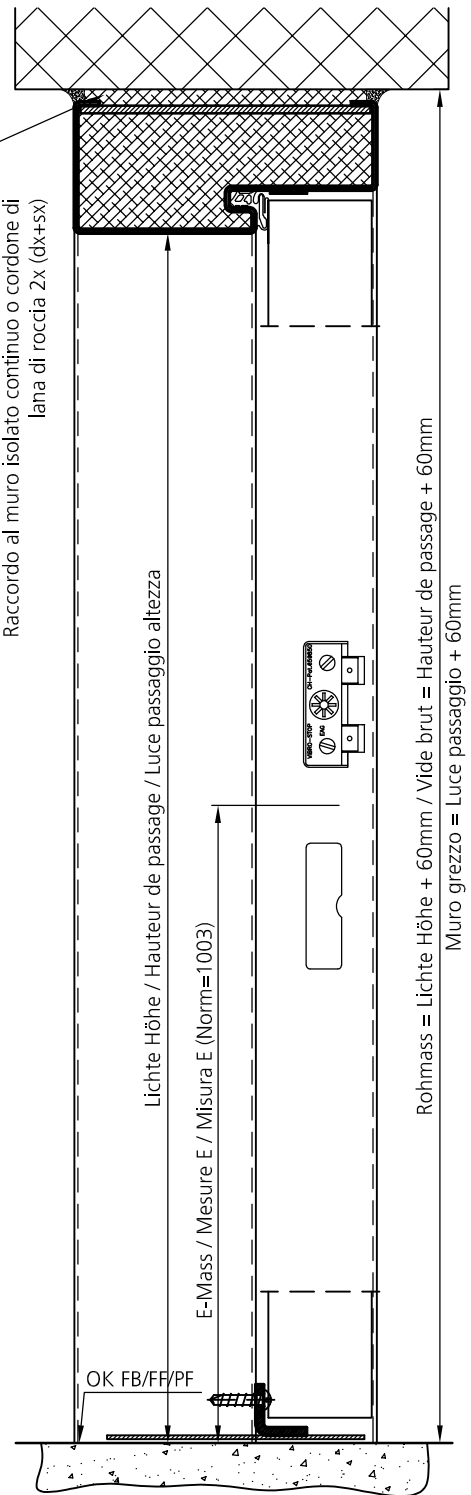
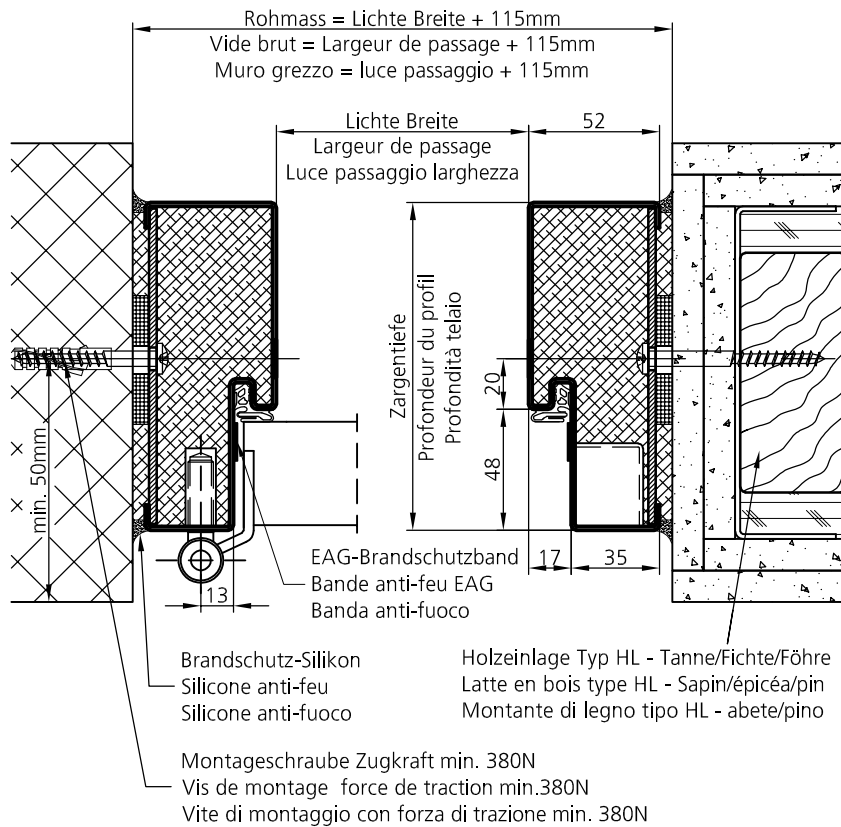

Bestellbeispiel gemäss Seite / Exemple de commande selon page / Esempio ordinazione vedi pagina 01.02.40/41

W.UDS.TM.EI30

Masstab

Version:

P.Stacher

23.06.2017

1:3

ELKUCH EISENRING AG
 Unterdorfstrasse 26
 CH-9243 Jonschwil



06.84.70

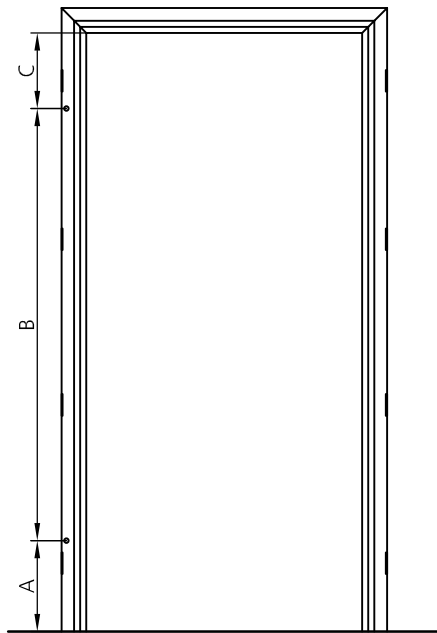

(Gezeichnet: Band links)
 (Dessin: Fiche gauche)
 (Disegnato: cerniere sx)

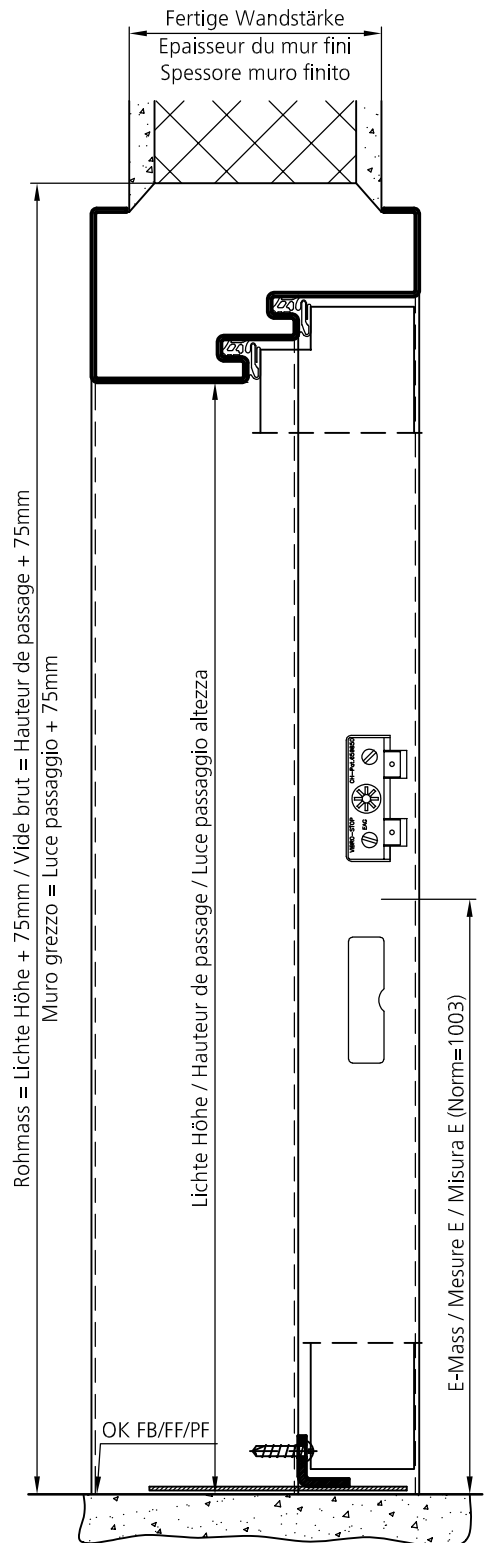
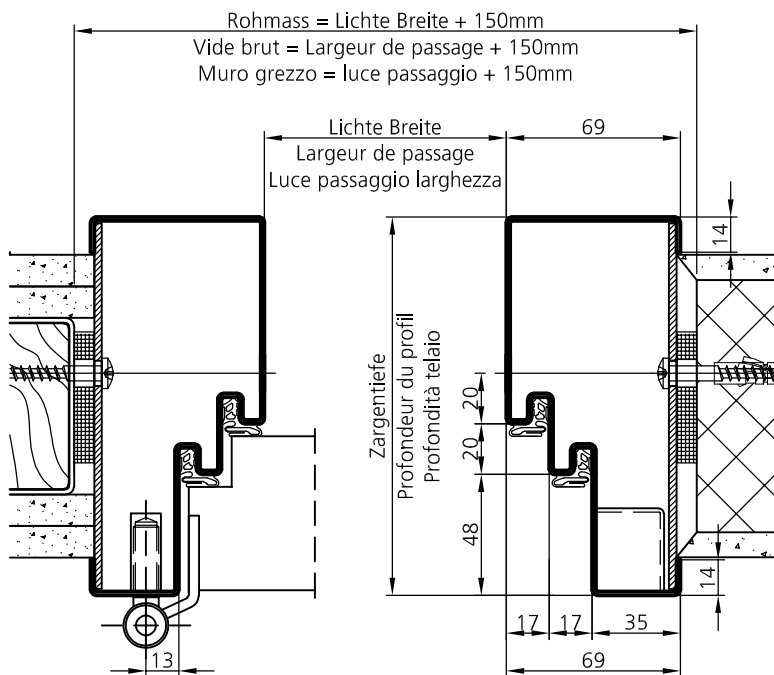

Bestellbeispiel gemäss Seite / Exemple de commande selon page / Esempio ordinazione vedi pagina 01.02.40/41

W.UDDS.TM

Masstab

Version:

P.Stacher

23.06.2017

1:3

ELKUCH EISENRING AG
 Unterdorfstrasse 26
 CH-9243 Jonschwil



ELKUCH EISENRING

06.86.20

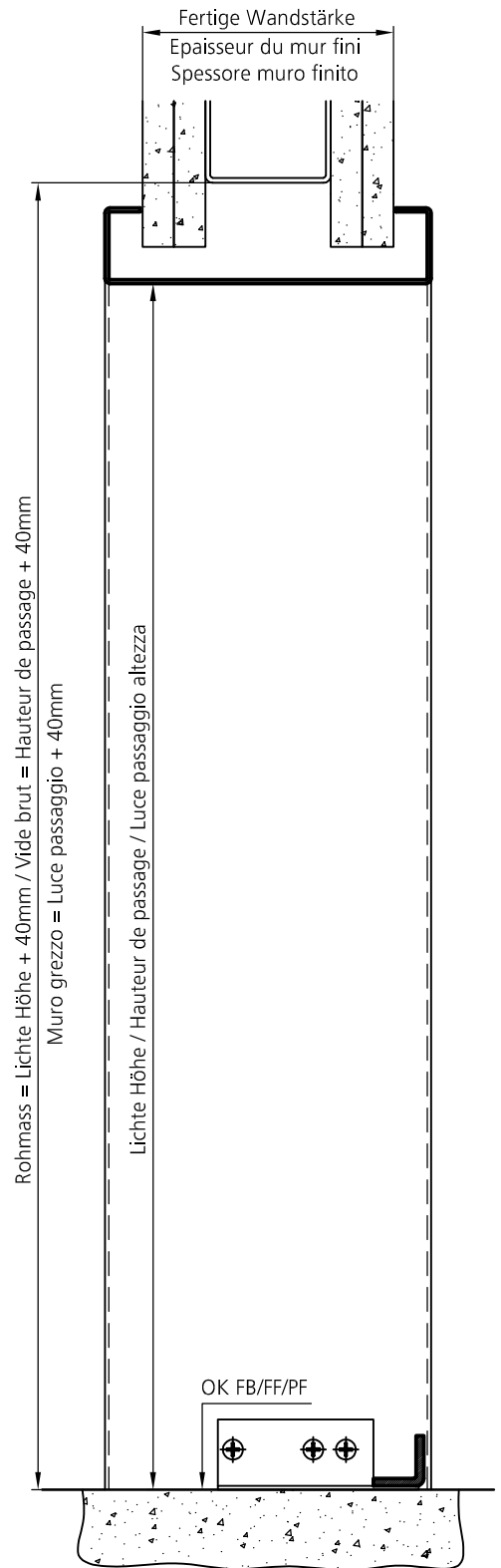
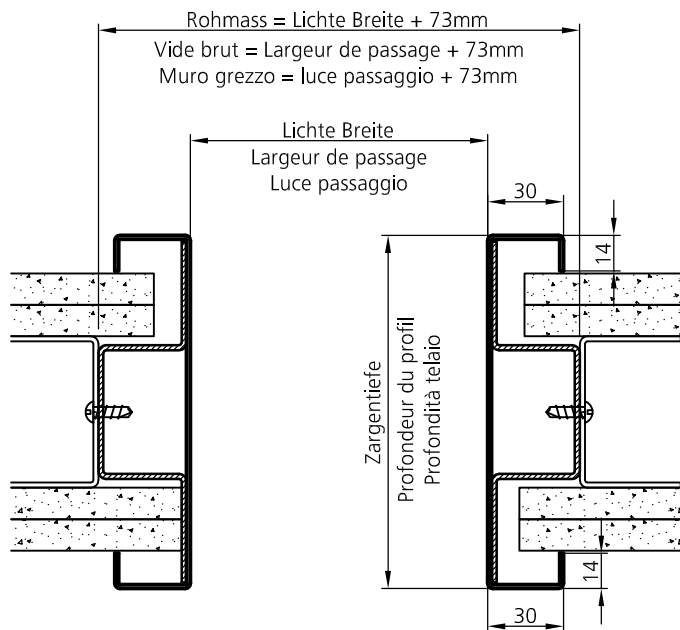
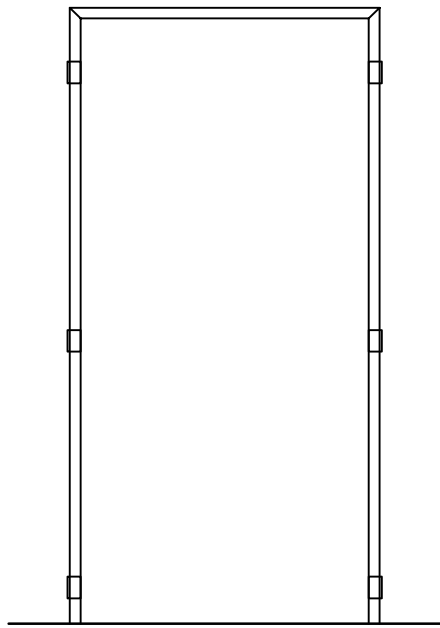

Bestellbeispiel gemäss Seite / Exemple de commande selon page / Esempio ordinazione vedi pagina 01.02.40/41

C.U.LBW

Masstab

Version:

P.Stacher

06.12.2016

1:3

ELKUCH EISENRING AG
 Unterdorfstrasse 26
 CH-9243 Jonschwil



06.90.00

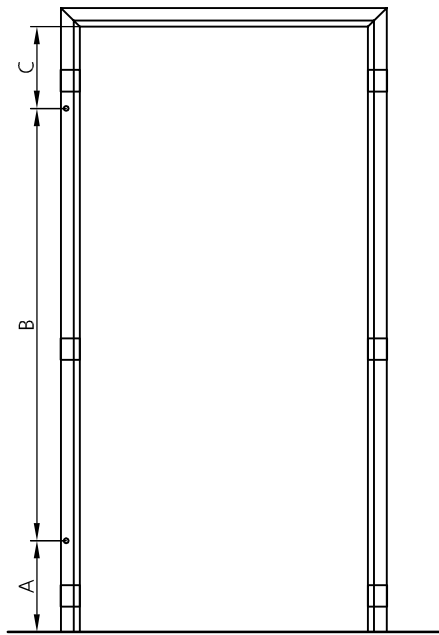

(Gezeichnet: Band links)
 (Dessin: Fiche gauche)
 (Disegnato: cerniere sx)

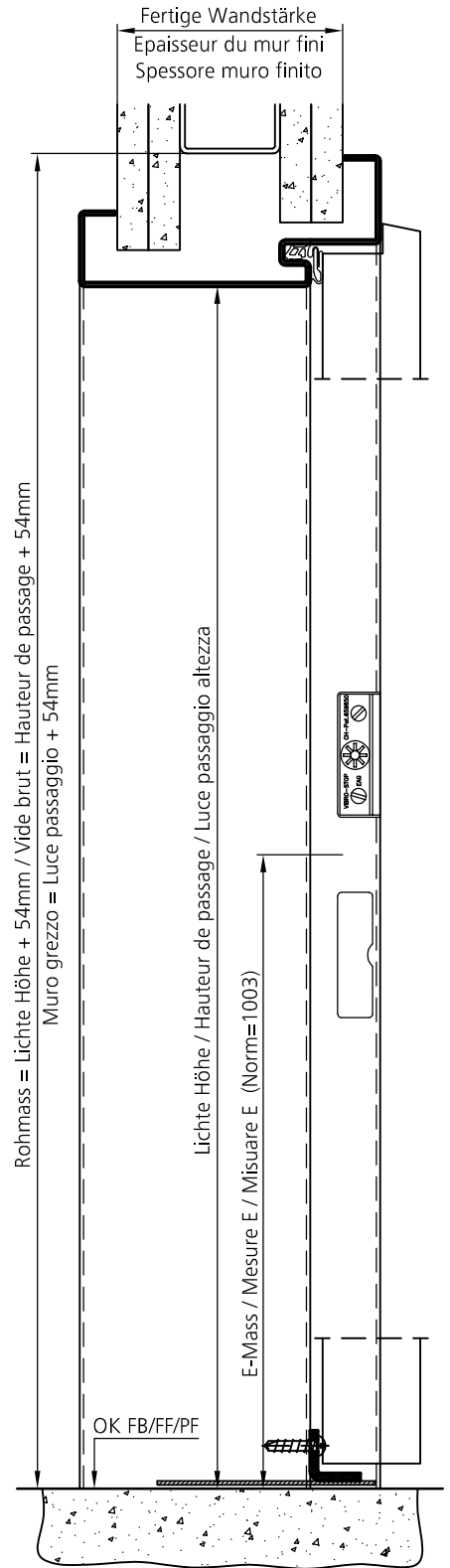
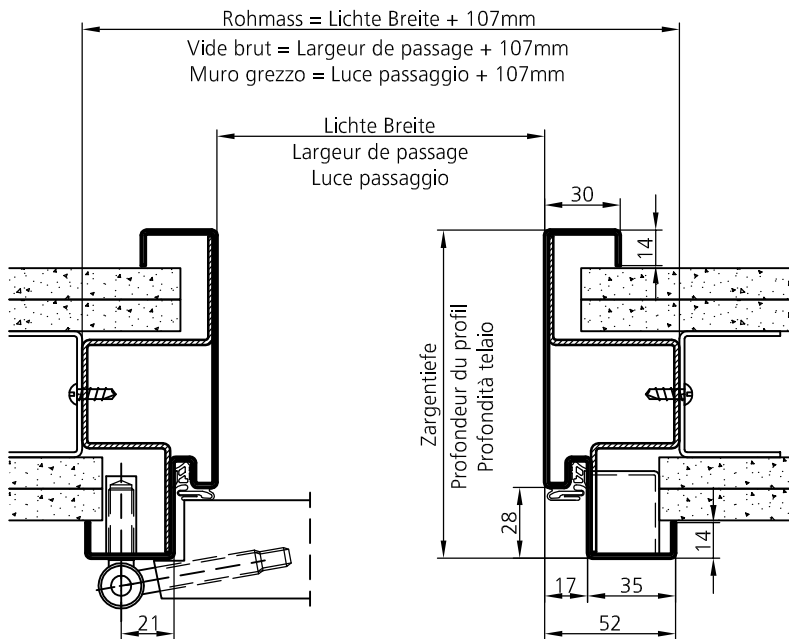

Bestellbeispiel gemäss Seite / Exemple de commande selon page / Esempio ordinazione vedi pagina 01.02.40/41

UD.LBW

Masstab

Version:

P.Stacher

01.12.2016

1:3

ELKUCH EISENRING AG
 Unterdorfstrasse 26
 CH-9243 Jonschwil



06.90.01

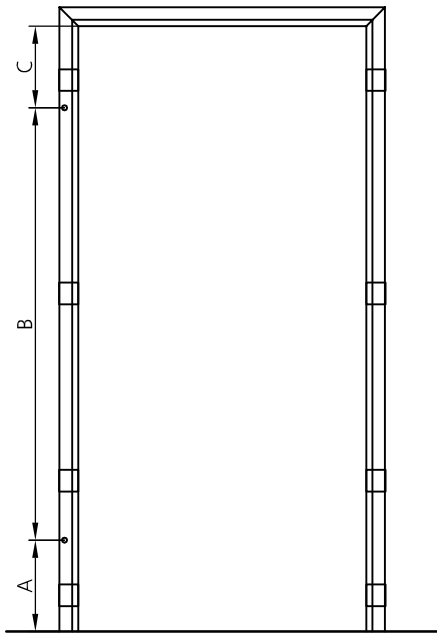

(Gezeichnet: Band links)
(Dessin: Fiche gauche)
(Disegnato: cerniere sx)

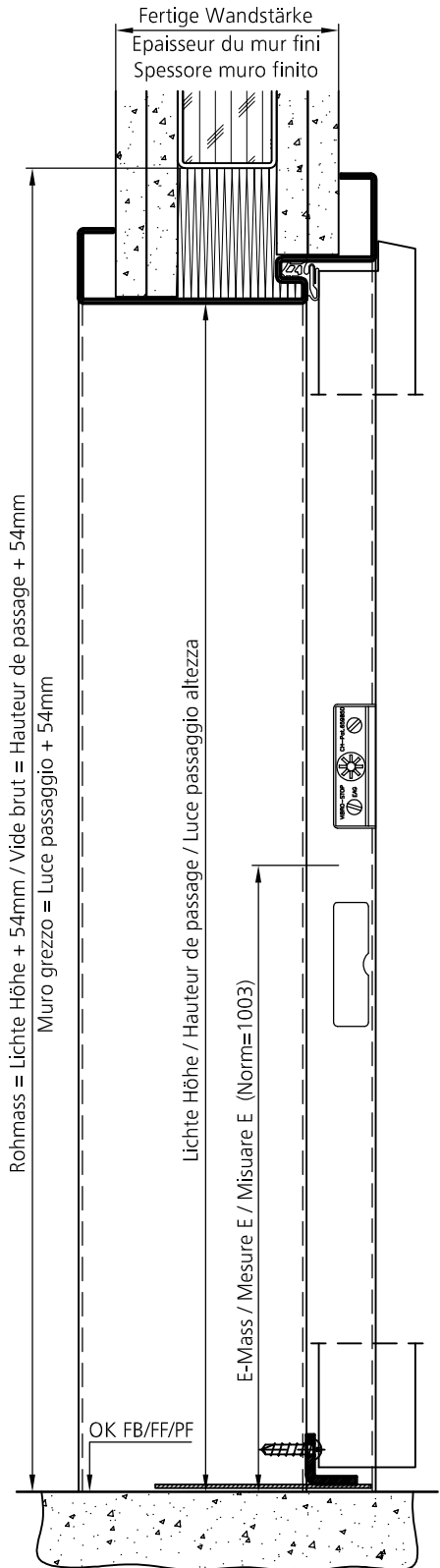
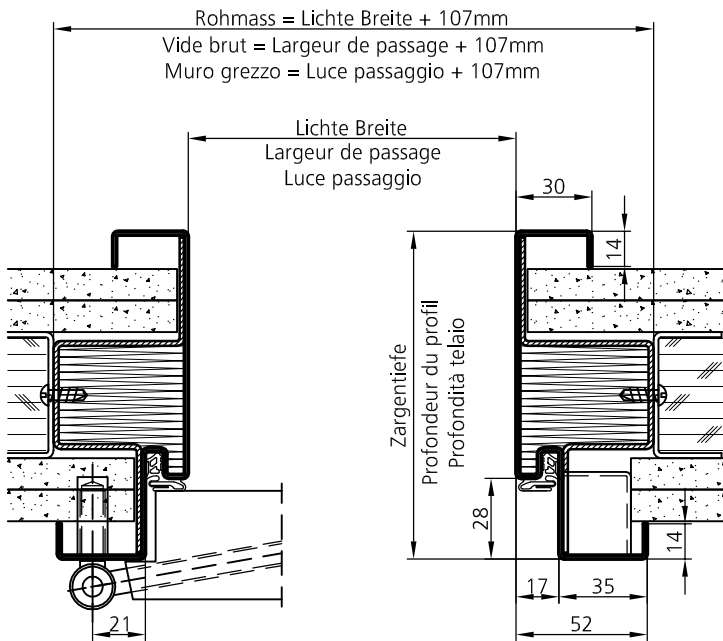

LBW4 (EI30) = 4 Bügel, ohne Roku-Strip / 4 étrier, sans Roku-Strip / 4 staffa, senza Roku-Strip
Bestellbeispiel gemäss Seite / Exemple de commande selon page / Esempio ordinazione vedi pagina 01.02.40/41

UD.LBW4

Masstab

Version:

P.Stacher

06.12.2016

1:3

ELKUCH EISENRING AG
Unterdorfstrasse 26
CH-9243 Jonschwil



06.90.02

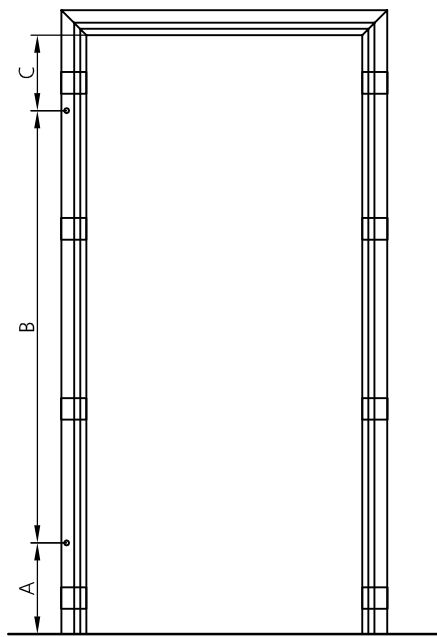

(Gezeichnet: Band links)
 (Dessin: Fiche gauche)
 (Disegnato: cerniere sx)

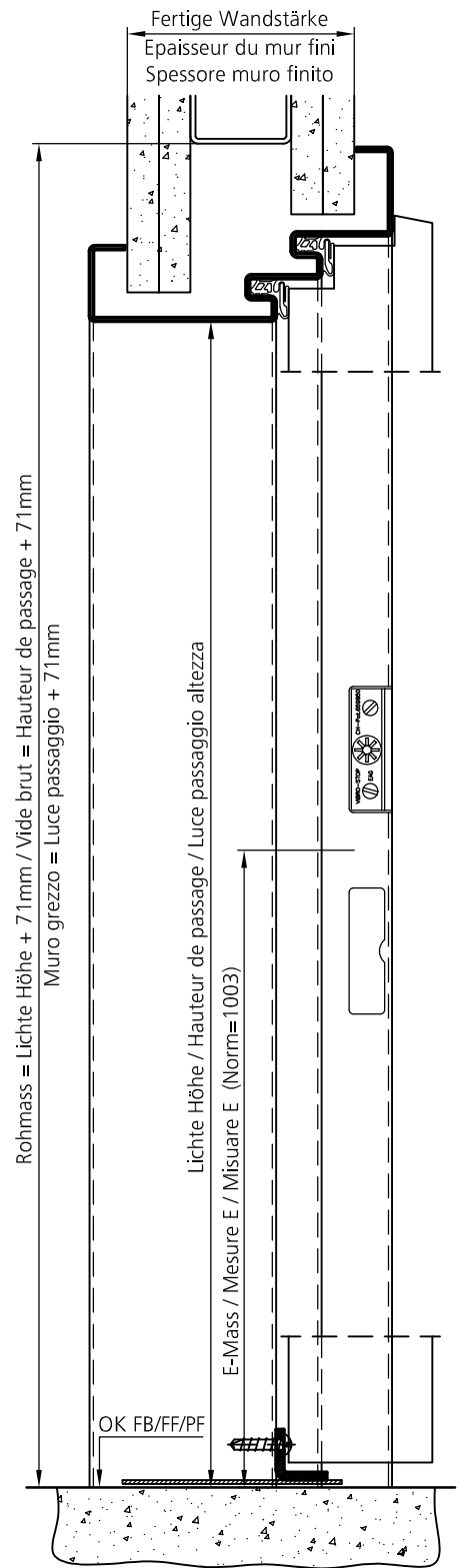
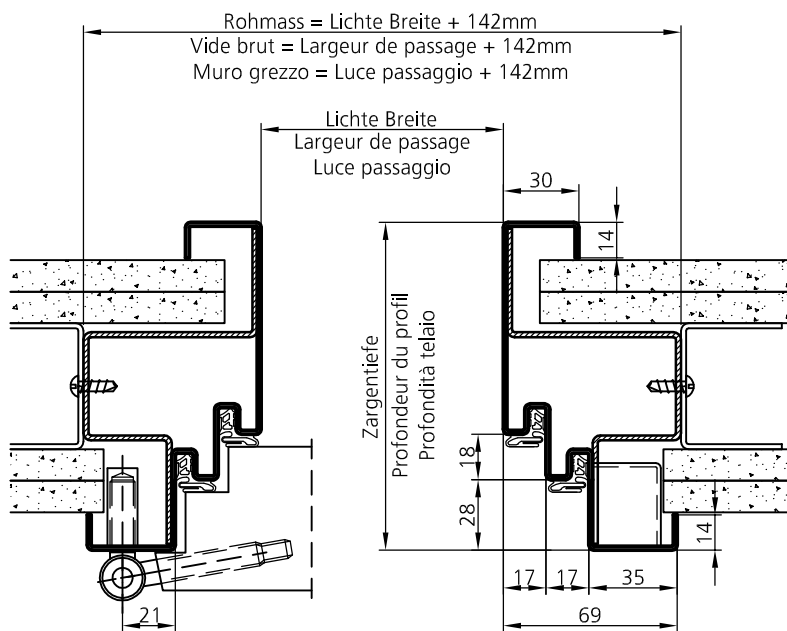

Bestellbeispiel gemäss Seite / Exemple de commande selon page / Esempio ordinazione vedi pagina 01.02.40/41

UDD.LBW

Masstab

Version:

P.Stacher

01.12.2016

1:3

ELKUCH EISENRING AG
 Unterdorfstrasse 26
 CH-9243 Jonschwil



06.92.01

Lagerzarge UDS.LBW4 mit lichter Höhe von 2000 mm Huisserie UDS.LBW4 de stock avec hauteur de passage de 2000 mm Telaio UDS.LBW4 con luce di passaggio 2000 mm

- 2x Bandklotz M10x1 (für Bandtypen: 16-4, 18-4 oder 18-4V, optional)
2x taquets M10x1 (pour types de fiches: 16-4, 18-4 ou 18-4V, en option)
2 blocchetti M10x1 (per le cerniere 16-4, 18-4 e 18-4V (optional))
- Bandung nach EAG-Norm / Position des fiches selon norme EAG /
Posizione cerniere seconda norma EAG (A=253, B=1500, C=247mm)
- Vibro-Riegel Ausschnitt mit E-Mass = 1003mm / Entaille pêne Vibro avec mesure E = 1003 mm
Intaglio Vibro con misura E = 1003 mm
- 4 LBW-Bügel pro Seite / 4 étriers pour cloison légère par côté / 4 staffa per lato telaio
- Ohne Bodeneinstand, provisorischer Schwelle VFS-10 / Sans talon, seuil provisoire VFS-10
Senza annegamento, soglia provvisoria VFS-10
- 40mm Bodeneinstand nur für Zarge: 180/800/2000mm, mit prov. Schwelle VFS /
Talon de 40 mm seulement pour huisserie: 180/800/2000 mm, avec seuil provisoire VFS /
Con annegamento 40mm solo per il profilo 180/800/2000 mm con soglia provvisoria VFS

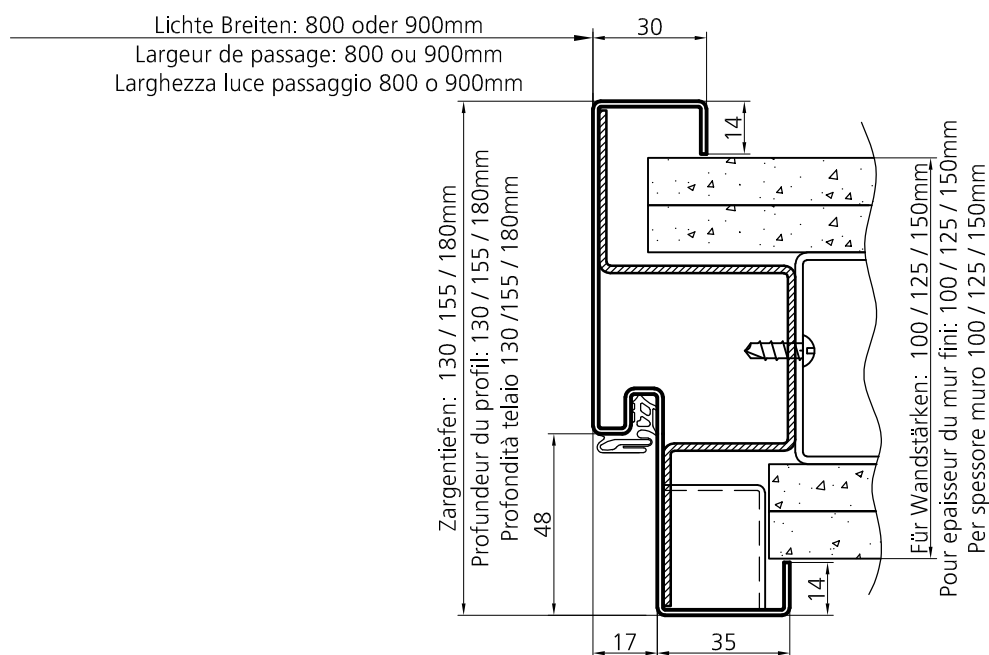

Liefertermine: Abholbereit ab Rampe EAG, oder 1-2 Arbeitstage je nach Transport
Délais de livraison: prêt à emporter départ rampe EAG ou en 1-2 jours ouvrables suivant le type de transport
Termini di fornitura: pronti consegna da rampa EAG o 1-2 lavorativi, a dipendenza del trasporto

Bestellformular siehe Seite / Formulaire de commande selon page / Formulario ordinazione vedi pagina 00.00.05
LBW4 (EI30) = 4 Bügel, ohne Roku-Strip / 4 étrier, sans Roku-Strip / 4 staffa, senza Roku-Strip

UDS.LBW4 (Lagerzarge)

Huisserie de stock / Telaio da stock

Massstab

Version:

P.Stacher

24.04.2017

1:2

ELKUCH EISENRING AG
Unterdorfstrasse 26
CH-9243 Jonschwil



06.94.00

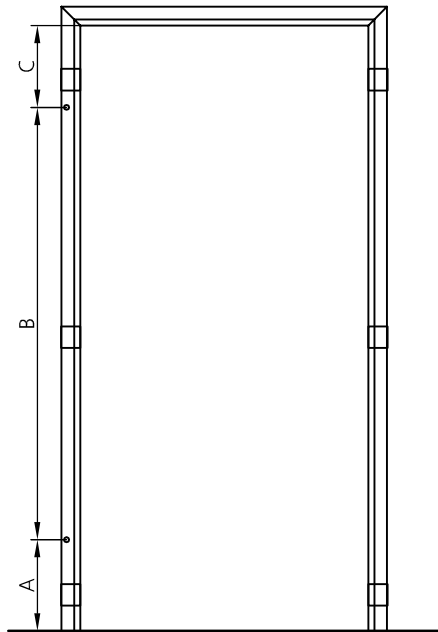

(Gezeichnet: Band links)
 (Dessin: Fiche gauche)
 (Disegnato: cerniere sx)

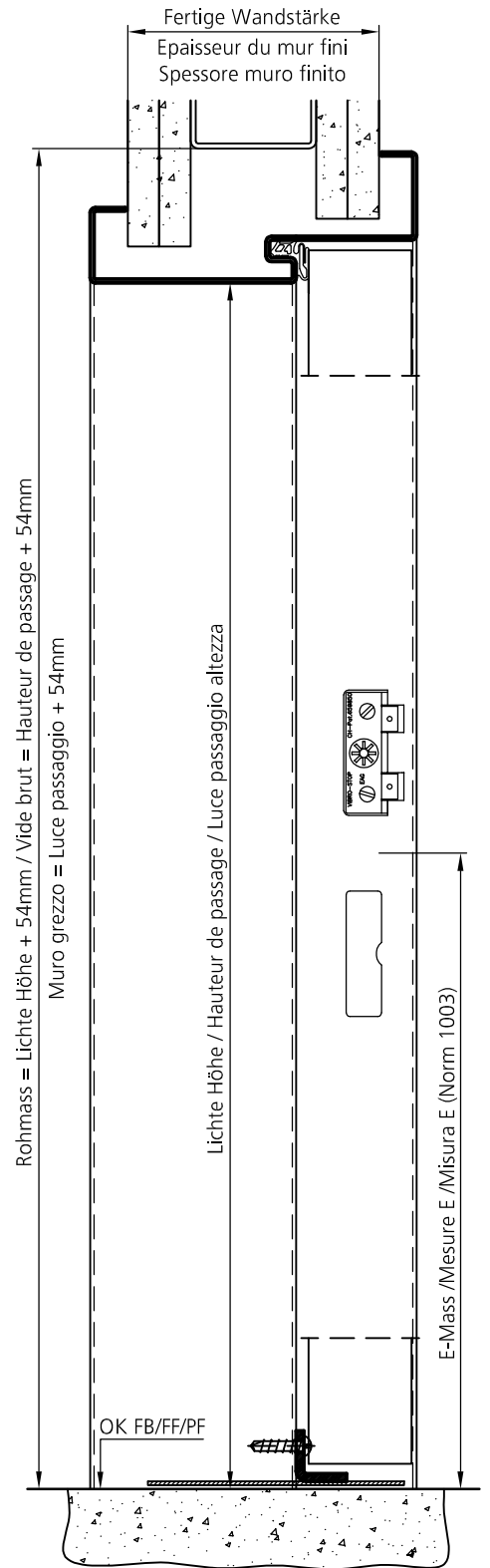
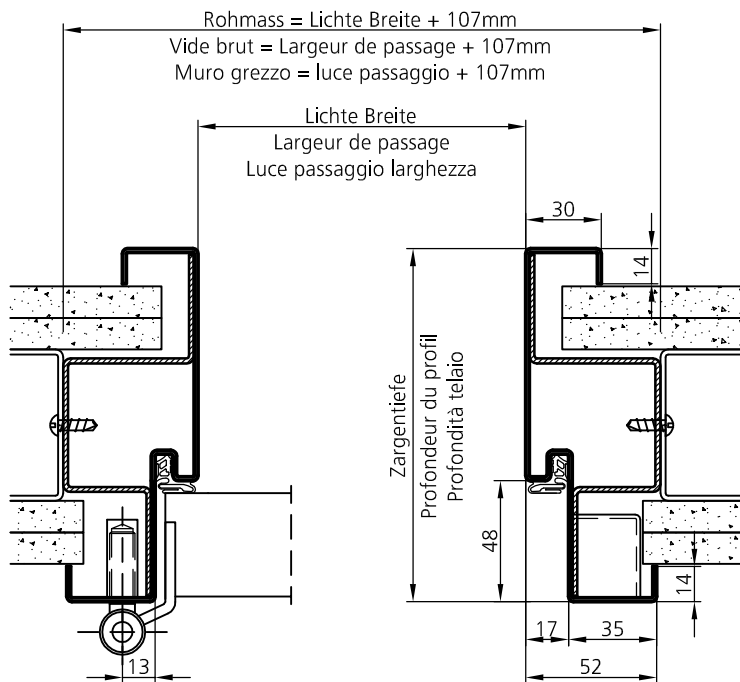

Bestellbeispiel gemäss Seite / Exemple de commande selon page / Esempio ordinazione vedi pagina 01.02.40/41

UDS.LBW

Masstab

Version:

P.Stacher

02.12.2016

1:3

ELKUCH EISENRING AG
 Unterdorfstrasse 26
 CH-9243 Jonschwil



06.94.01

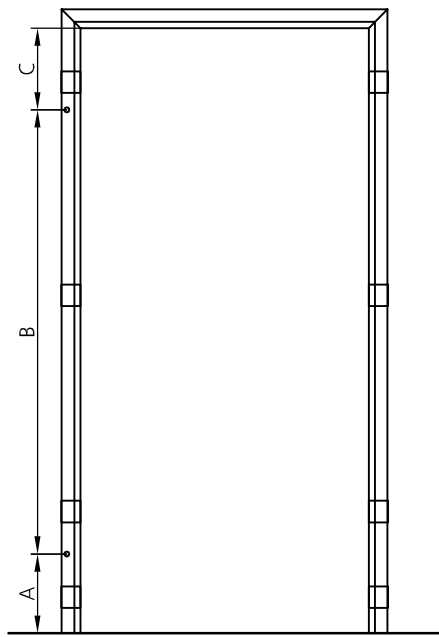

(Gezeichnet: Band links)
 (Dessin: Fiche gauche)
 (Disegnato: cerniere sx)

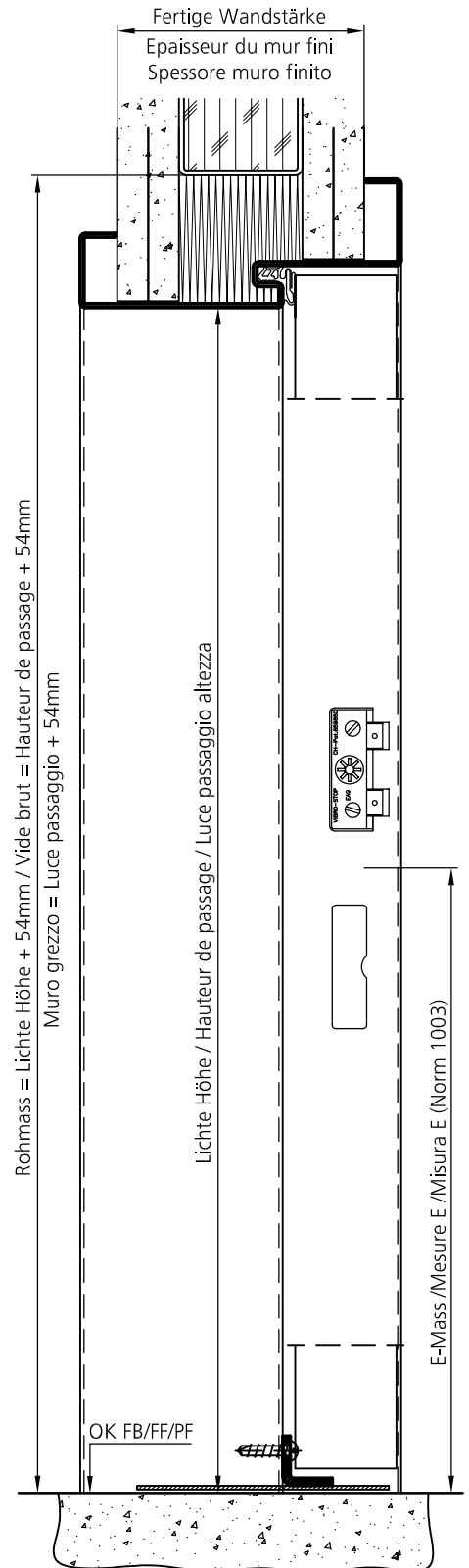
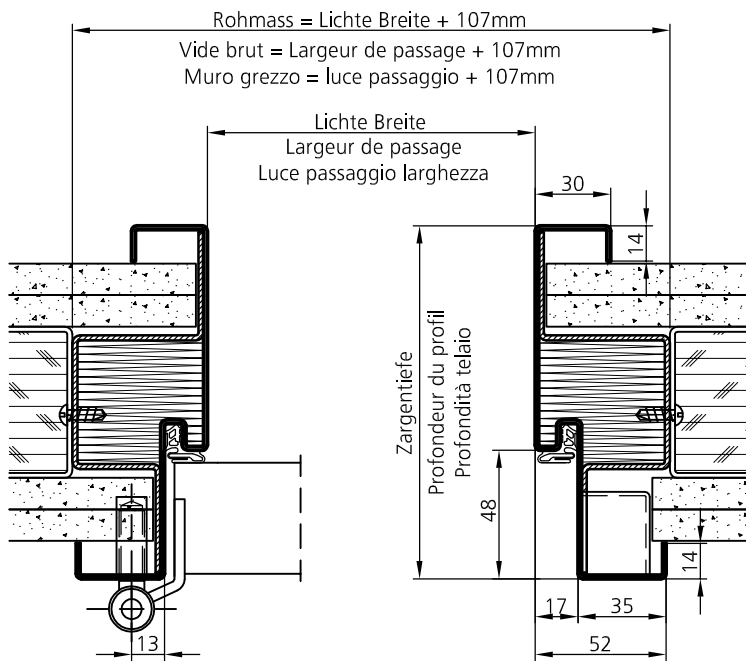

LBW4 (EI30) = 4 Bügel, ohne Roku-Strip / 4 étrier, sans Roku-Strip / 4 staffa, senza Roku-Strip
 Bestellbeispiel gemäss Seite / Exemple de commande selon page / Esempio ordinazione vedi pagina 01.02.40/41

UDS.LBW4

Masstab Version: P.Stacher 06.12.2016

1:3

ELKUCH EISENRING AG
 Unterdorfstrasse 26
 CH-9243 Jonschwil



06.94.02

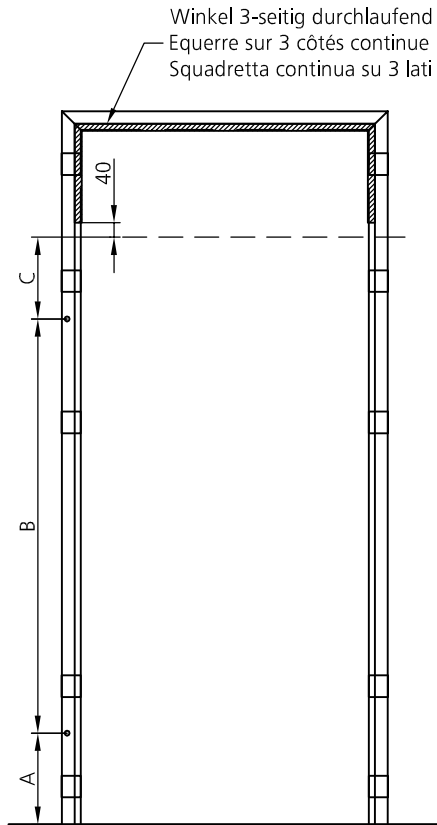

Detail: Blendenbefestigung
 Détail: fixation attique
 Dettaglio: fissaggio del sopraluce

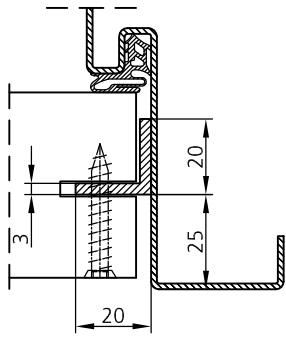

(Gezeichnet: Band links)
 (Dessin: Fiche gauche)
 (Disegnato: cerniere sx)

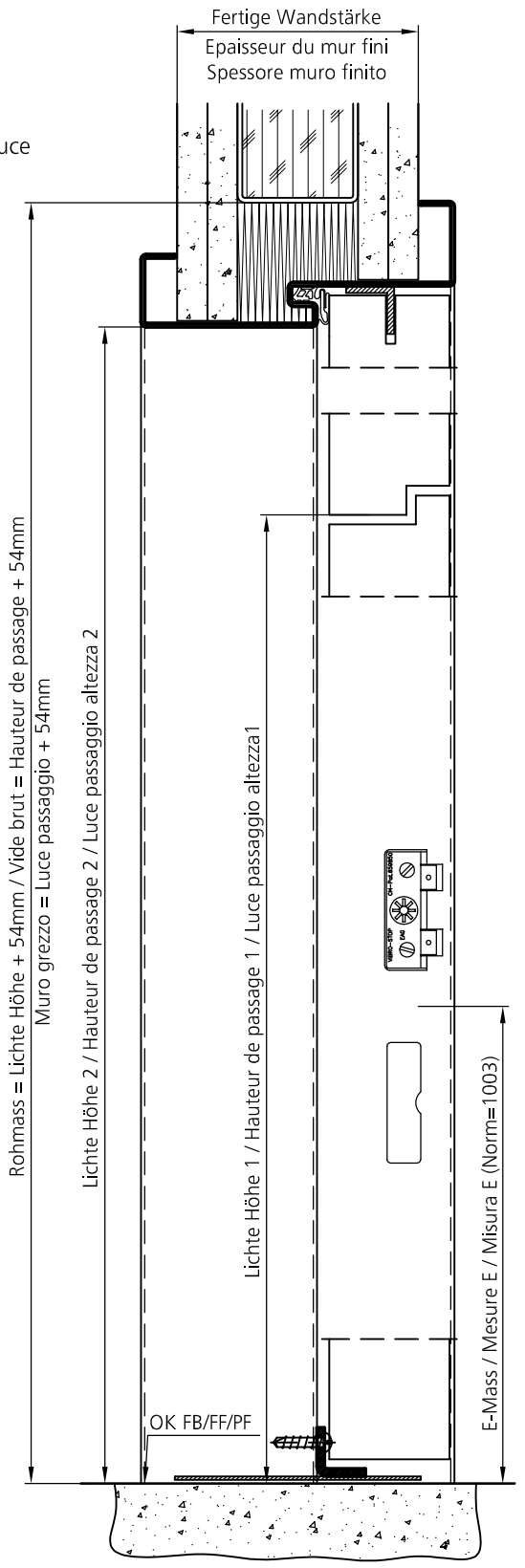
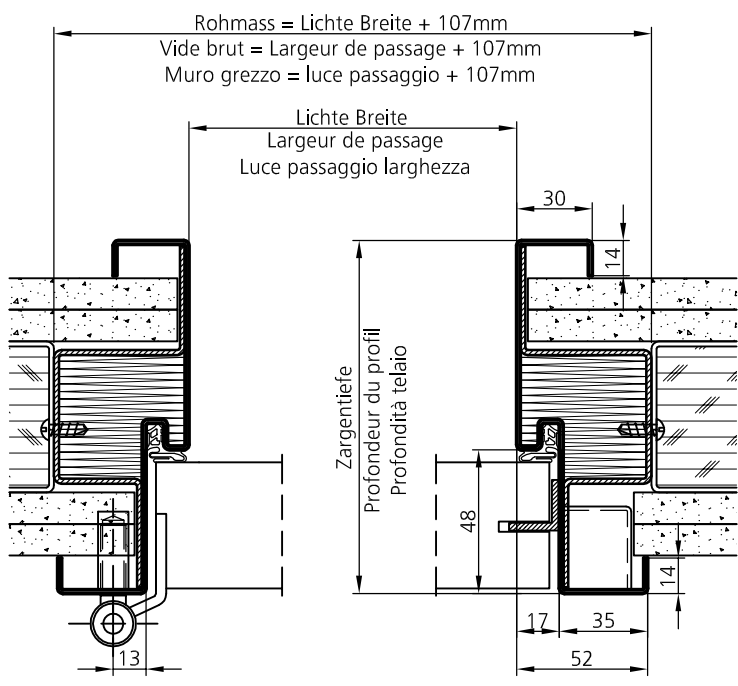

LBW4 (EI30) = 4 Bügel, ohne Roku-Strip / 4 étrier, sans Roku-Strip / 4 staffa, senza Roku-Strip
 Bestellbeispiel gemäss Seite / Exemple de commande selon page / Esempio ordinazione vedi pagina 01.02.40/41

B3.UDS.LBW4

Masstab 1:3 Version: P.Stacher 02.12.2016

ELKUCH EISENRING AG
 Unterdorfstrasse 26
 CH-9243 Jonschwil



06.94.04

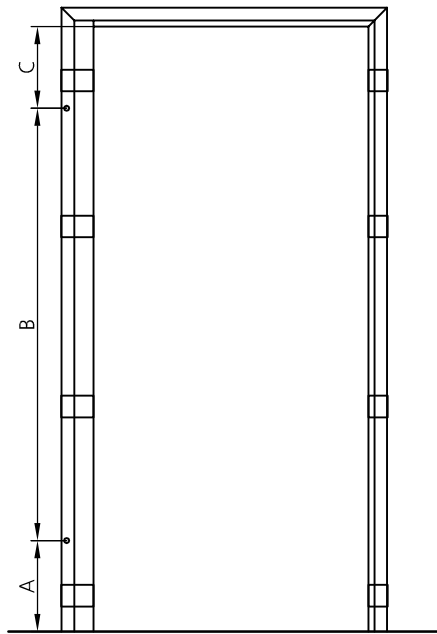

(Gezeichnet: Band links)
 (Dessin: Fiche gauche)
 (Disegnato: cerniere sx)

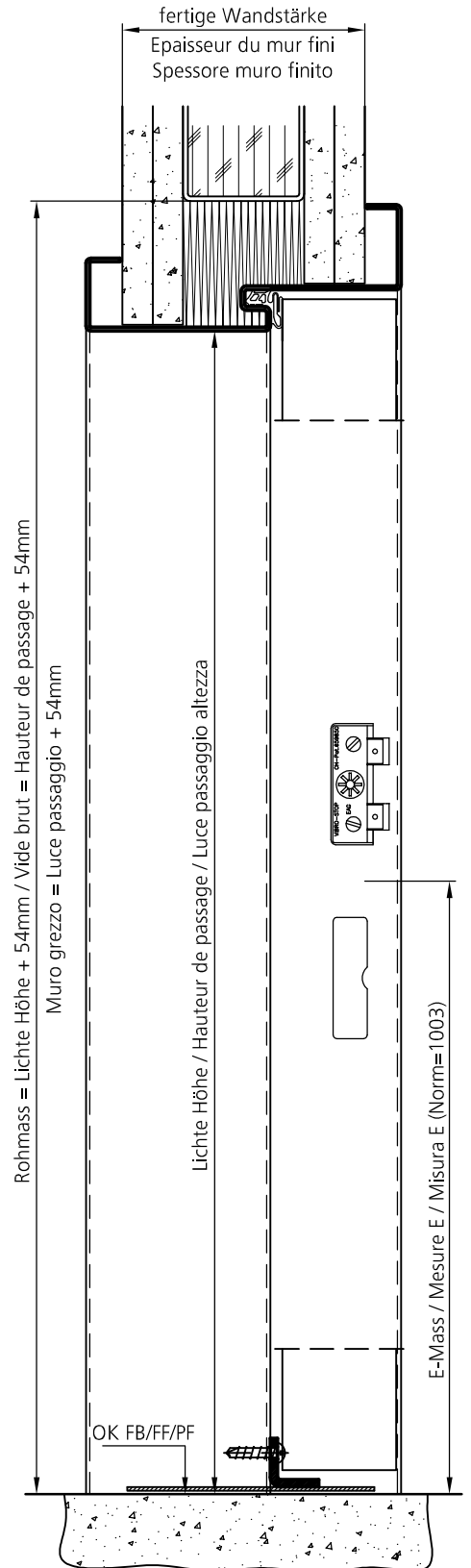
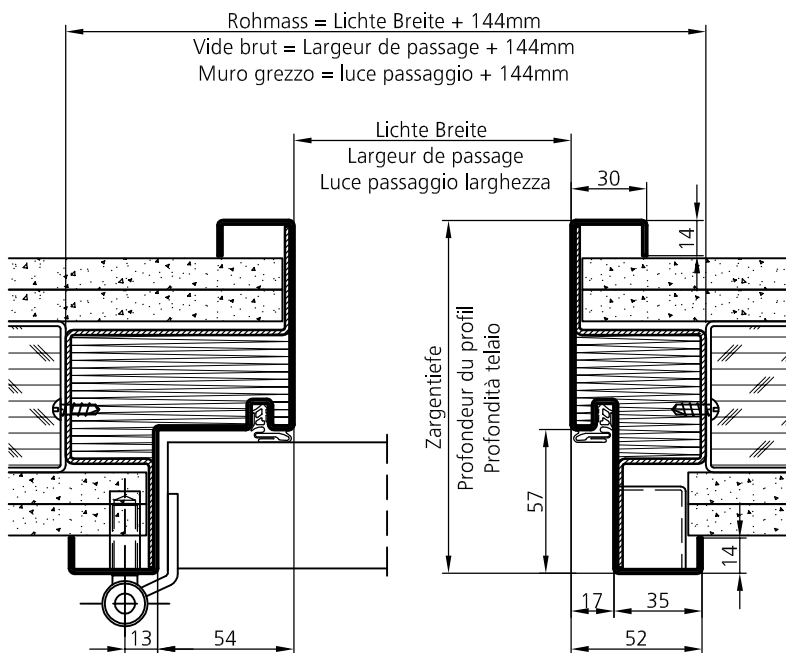

Bestellbeispiel gemäss Seite / Exemple de commande selon page / Esempio ordinazione vedi pagina 01.02.40/41

UDS57.SP.LBW

Masstab Version: P.Stacher 02.12.2016

1:3

ELKUCH EISENRING AG
 Unterdorfstrasse 26
 CH-9243 Jonschwil



06.94.07

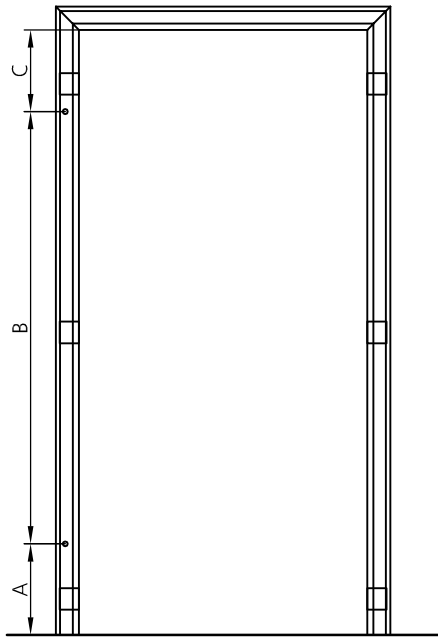

(Gezeichnet: Band links)
 (Dessin: Fiche gauche)
 (Disegnato: cerniere sx)

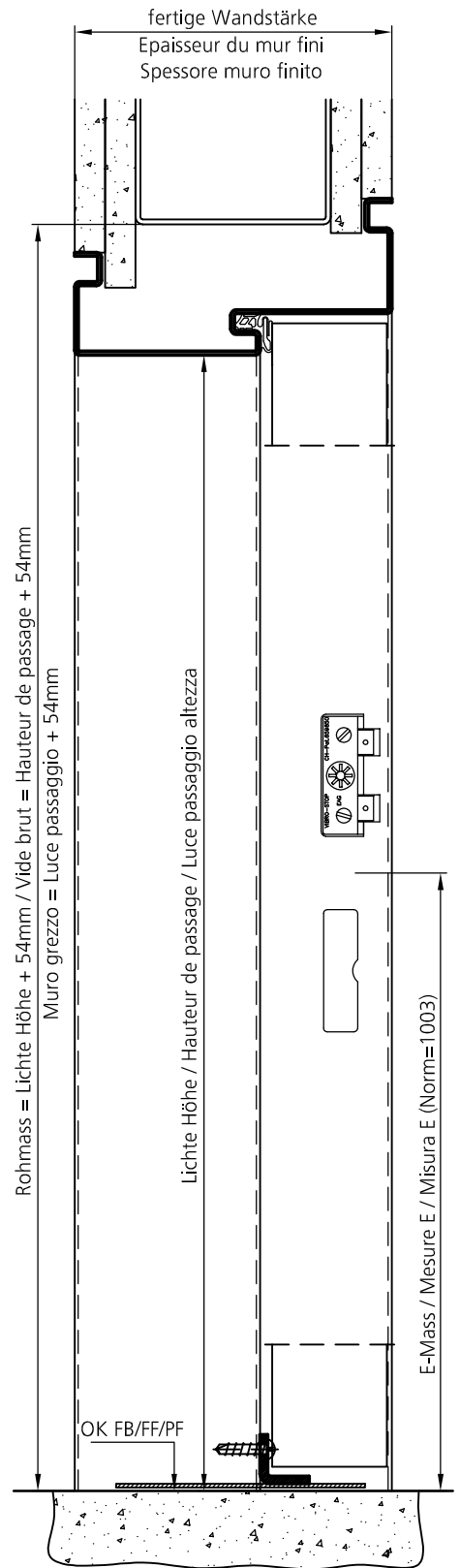
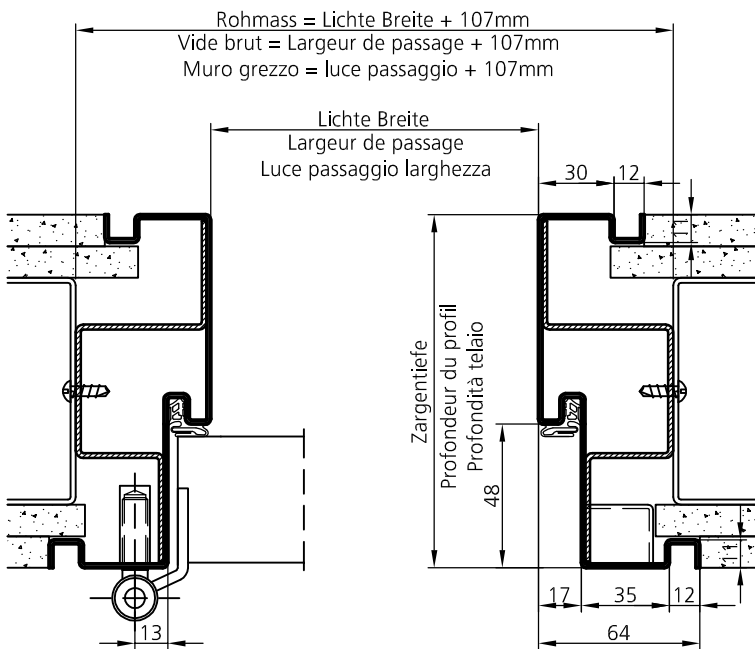

Bestellbeispiel gemäss Seite / Exemple de commande selon page / Esempio ordinazione vedi pagina 01.02.40/41

N.UDS.LBW

Masstab

Version:

P.Stacher

02.12.2016

1:3

ELKUCH EISENRING AG
 Unterdorfstrasse 26
 CH-9243 Jonschwil



06.94.09

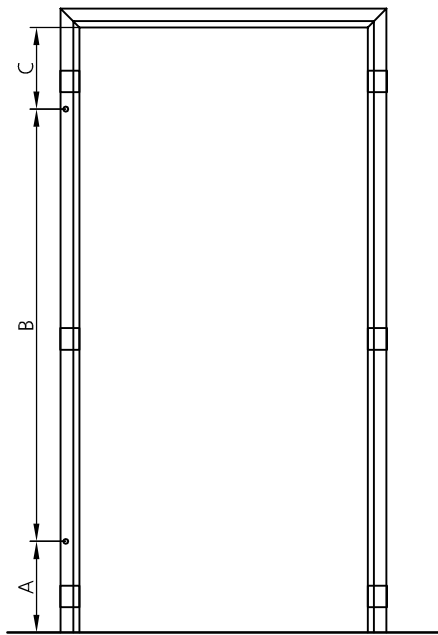

(Gezeichnet: Band links)
 (Dessin: Fiche gauche)
 (Disegnato: cerniere sx)

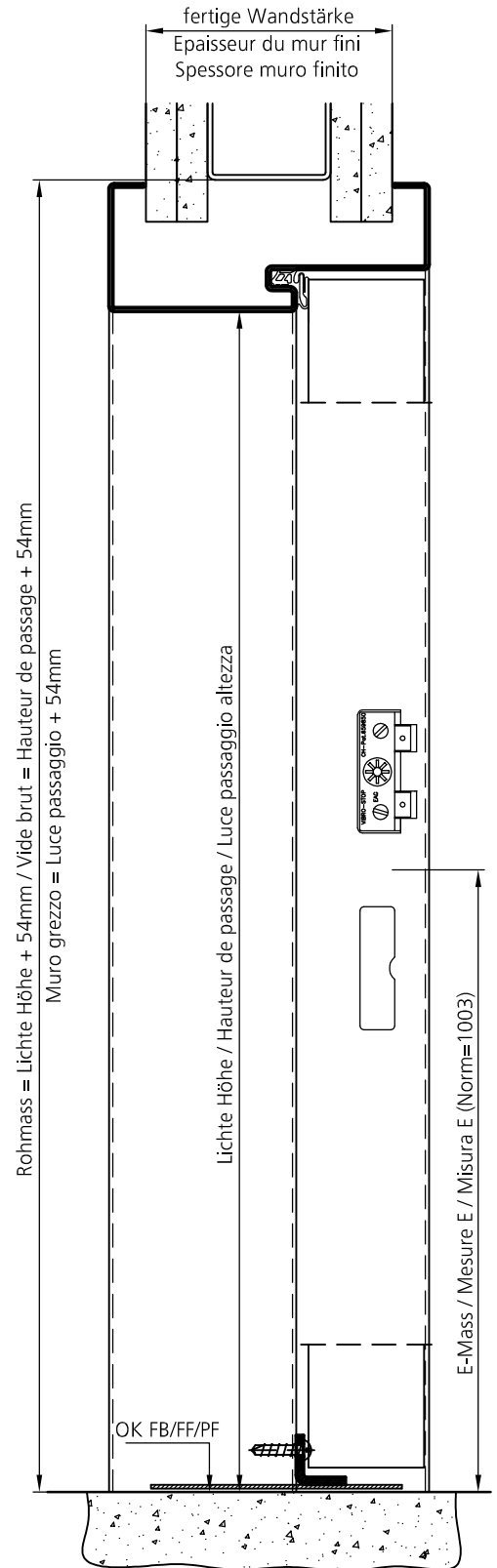
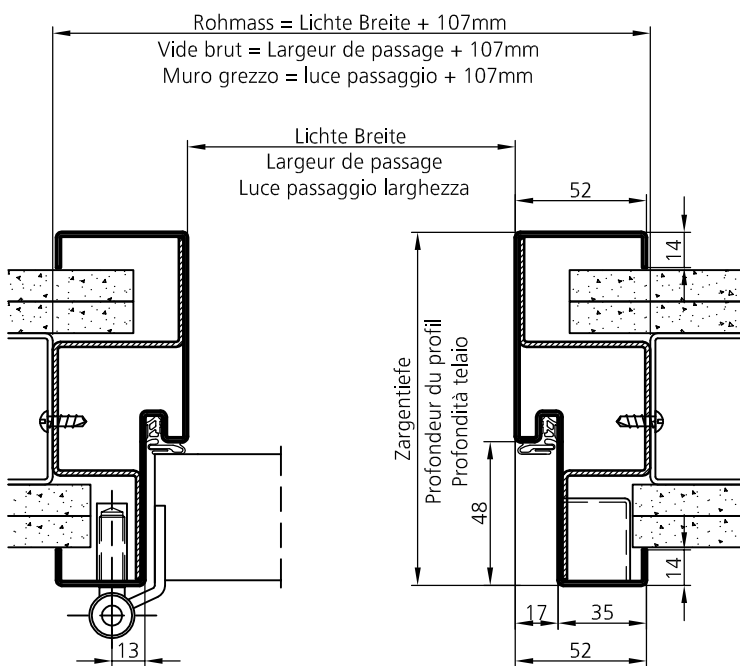

Bestellbeispiel gemäss Seite / Exemple de commande selon page / Esempio ordinazione vedi pagina 01.02.40/41

W.UDS.LBW

Masstab

Version:

P.Stacher

02.12.2016

1:3

ELKUCH EISENRING AG
 Unterdorfstrasse 26
 CH-9243 Jonschwil



ELKUCH EISENRING

06.94.10

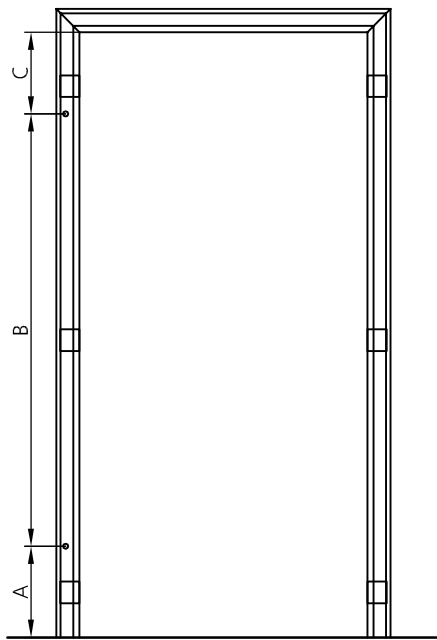

(Gezeichnet: Band links)
 (Dessin: Fiche gauche)
 (Disegnato: cerniere sx)

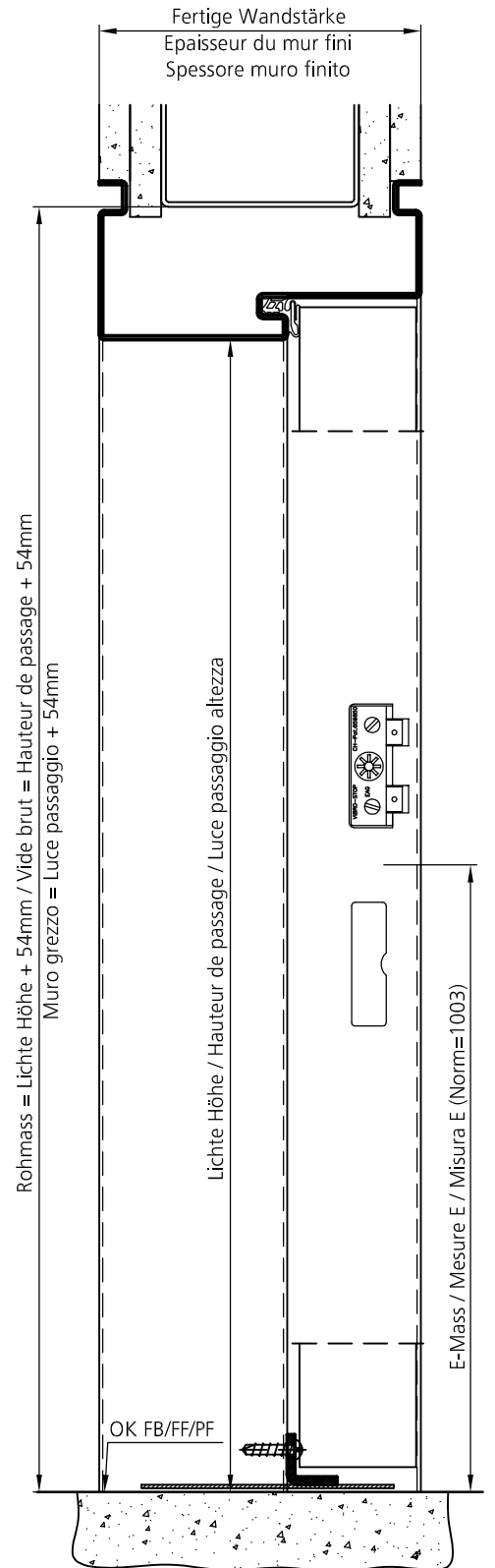
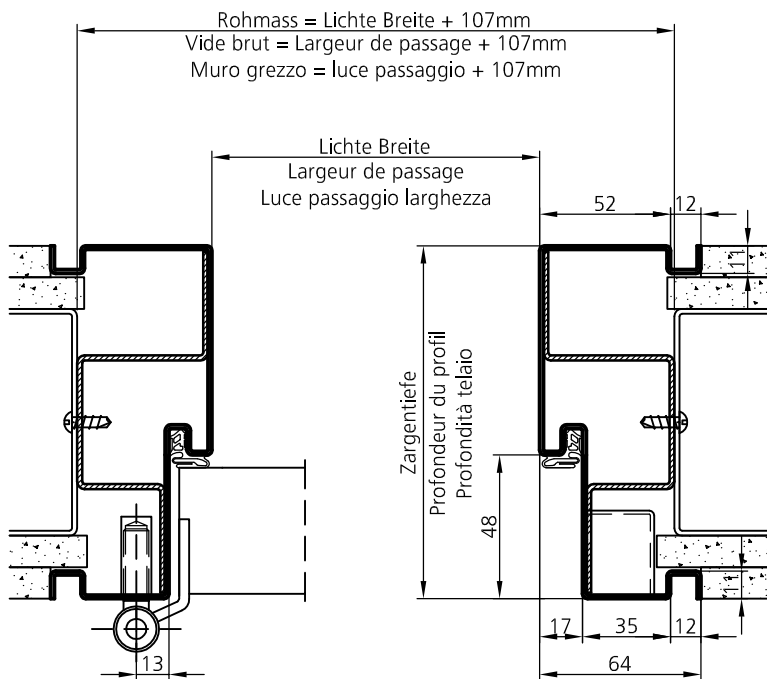

Bestellbeispiel gemäss Seite / Exemple de commande selon page / Esempio ordinazione vedi pagina 01.02.40/41

NW.UDS.LBW

Masstab

Version:

P.Stacher

02.12.2016

1:3

ELKUCH EISENRING AG
 Unterdorfstrasse 26
 CH-9243 Jonschwil



06.94.15

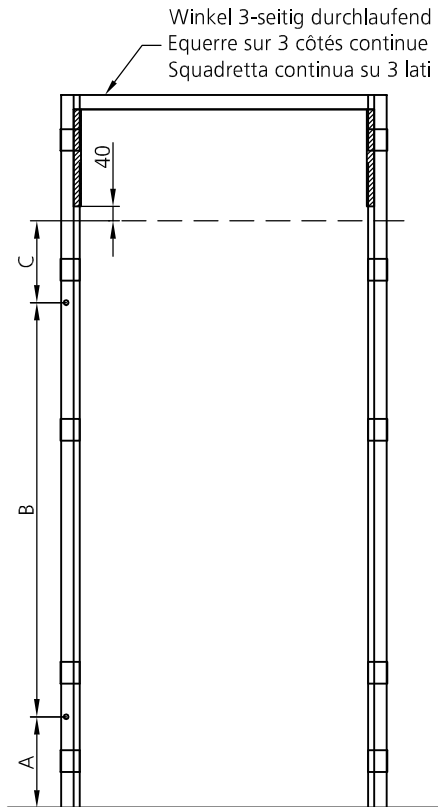

Winkel 3-seitig durchlaufend
 Equerre sur 3 côtés continue
 Squadretta continua su 3 lati

Detail: Blendenbefestigung
 Détail: fixation attique
 Dettaglio: fissaggio del sopraluce

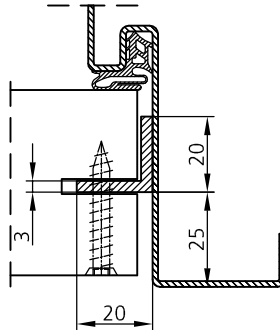

(Gezeichnet: Band links)
 (Dessin: Fiche gauche)
 (Disegnato: cerniere sx)

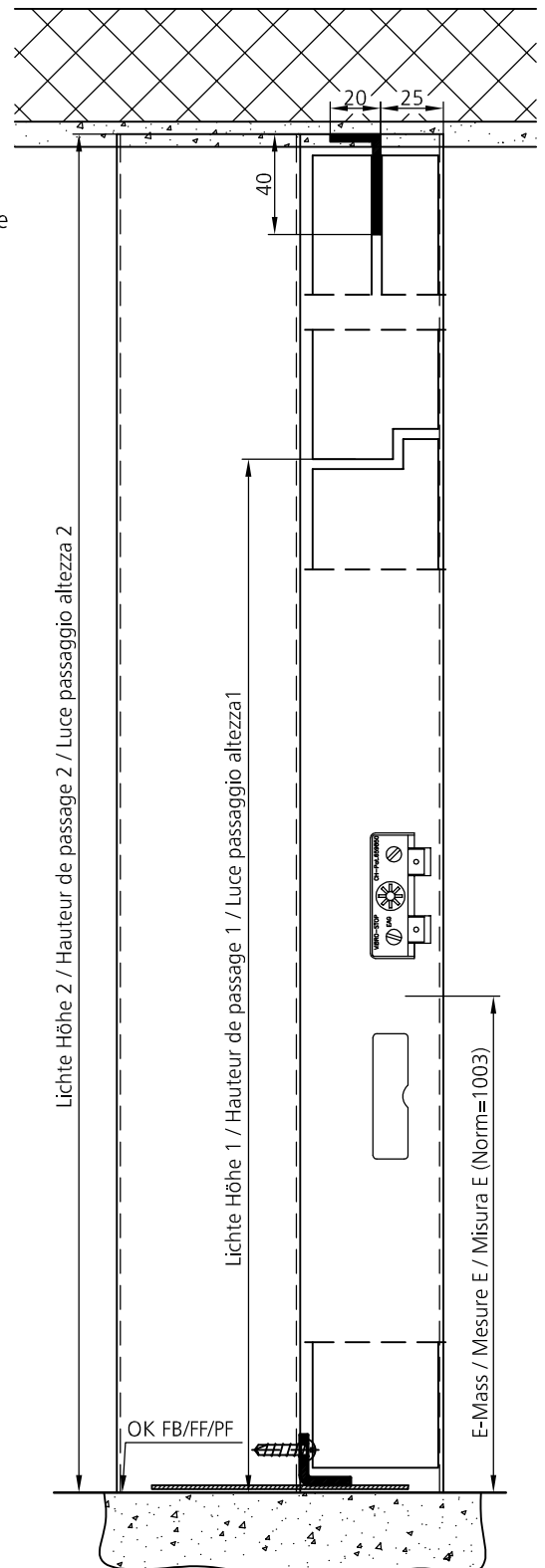
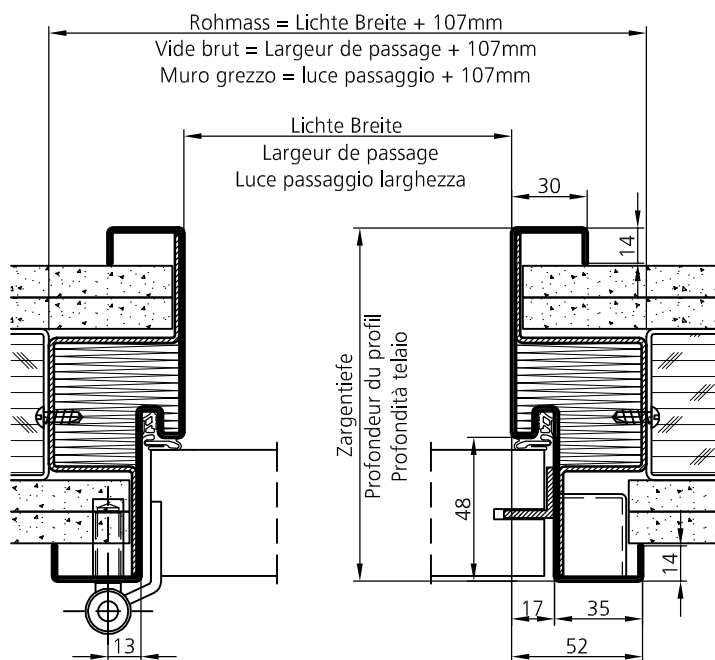

LBW4 (EI30) = 4 Bügel, ohne Roku-Strip / 4 étrier, sans Roku-Strip / 4 staffa, senza Roku-Strip
 Bestellbeispiel gemäss Seite / Exemple de commande selon page / Esempio ordinazione vedi pagina 01.02.40/41

H3.UDS.LBW4

Masstab Version: P.Stacher 02.12.2016

1:3

ELKUCH EISENRING AG
 Unterdorfstrasse 26
 CH-9243 Jonschwil



06.94.18

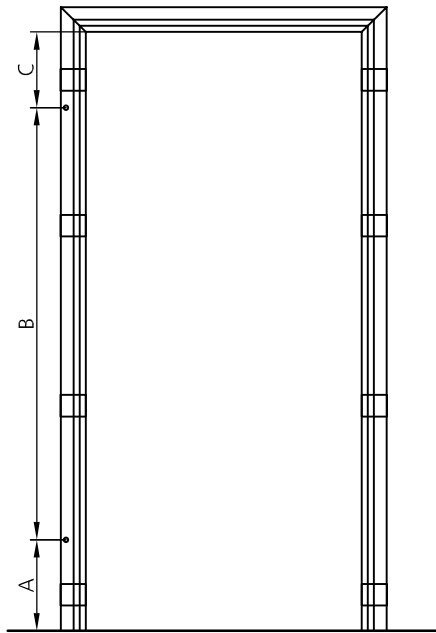

(Gezeichnet: Band links)
 (Dessin: Fiche gauche)
 (Disegnato: cerniere sx)

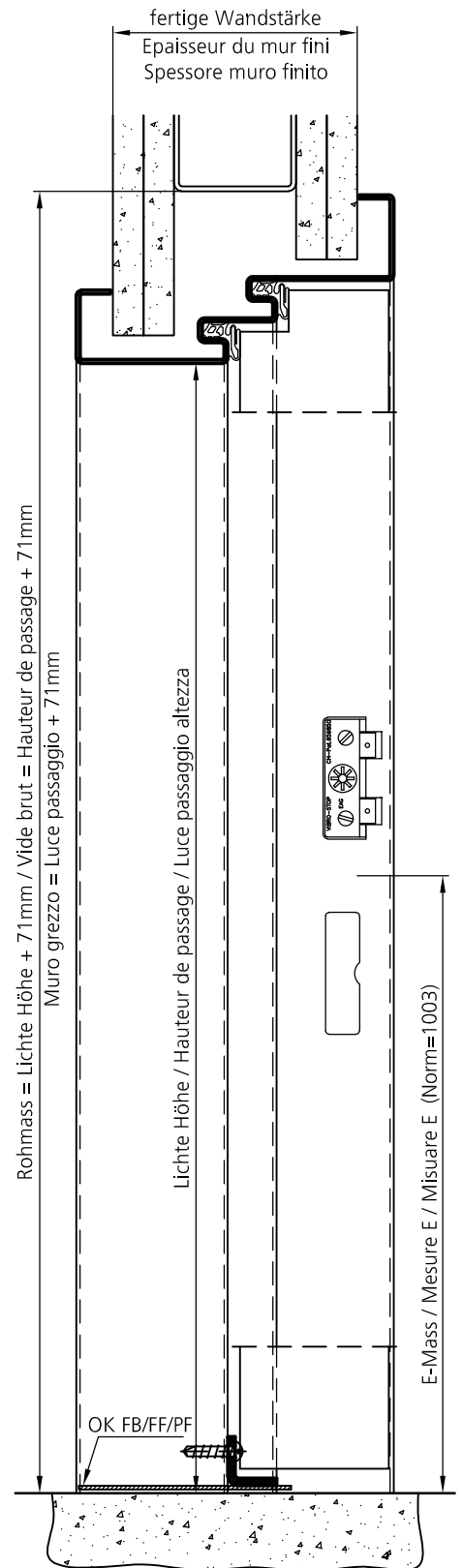
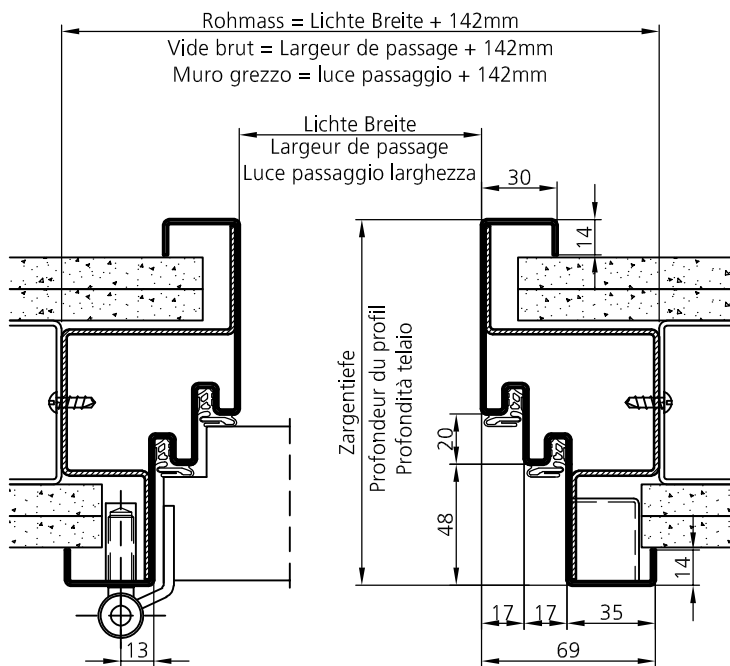

Bestellbeispiel gemäss Seite / Exemple de commande selon page / Esempio ordinazione vedi pagina 01.02.40/41

UDDS.LBW

Masstab 1:3 Version: P. Stacher 23.06.2017

ELKUCH EISENRING AG
 Unterdorfstrasse 26
 CH-9243 Jonschwil



06.96.01