



Conçu pour : Utilisation faible à intensive
Utilisation : Intérieur et extérieur
Variantes : Montage au sol, latéral et système profil engravé
Applications : Balcons, passerelles/cloisons, escaliers, protection de fenêtres
Matériau : Acier inoxydable 304 et 316 (inox brossé et poli miroir)

Projet inspiration:



[q-railing.com/
p-q-line](http://q-railing.com/p-q-line)

Q-LINE

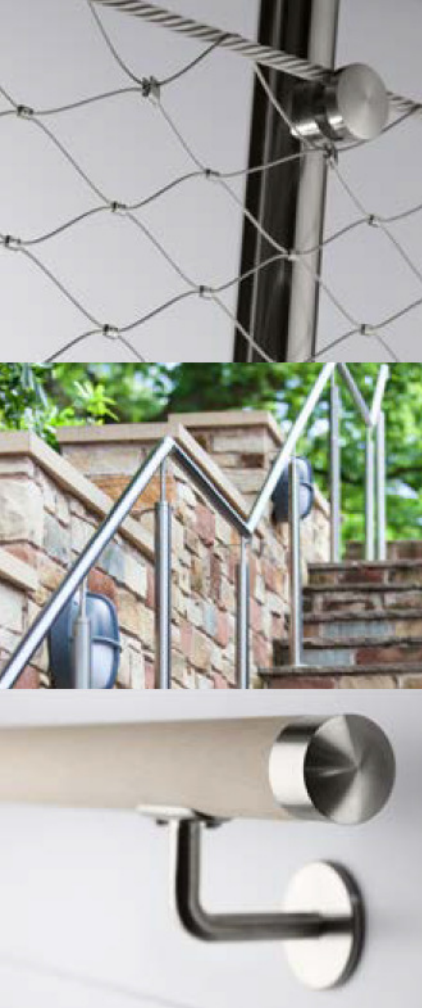

Un système aux possibilités infinies

Q-line est certainement notre système le plus polyvalent. Il se décline en une très large gamme d'éléments qui répondent à la plupart des défis architecturaux et à presque toutes les exigences spécifiques. Il vous permet même de créer un garde-corps avec une finition polie miroir intégrale. Pourquoi ne pas lui intégrer des éléments d'autres systèmes pour créer un design totalement unique ? Laissez libre cours à votre imagination.



q-railing.com/certificates

Tests/calculs/certificats internationaux:



- 1 La gamme Q-line est très variée avec différentes options de surface et de remplissage, des montages au sol et latéraux et même des solutions pour les escaliers.
- 2 Q-line comprend également un poteau à double paroi (montage au sol et latéral) vous permettant de créer un garde-corps avec des poteaux ronds résistant à des charges linéaires plus élevées.

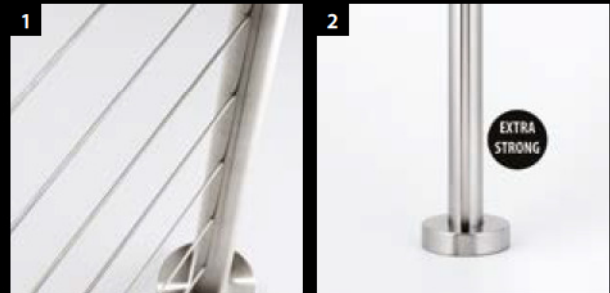

REMPLISSAGES Q-LINE

Verre

- Encadrement pour verre
- Pincés à verre
- Adaptateurs à verre
- Supports de verre



☞ 290 - 293

Barre et tube

- Remplissages horizontaux
- Remplissages verticaux



☞ 294 - 307

Câble

- Fast Fix Ø 3,2 mm
- Fast Fix Ø 4,0 mm
- Ø 3,2 mm
- Ø 6,0 mm

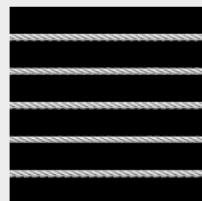

☞ 308 - 315

Filet

- Easy Q-web

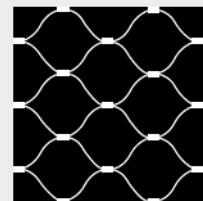

☞ 316 - 319

Panneau de tôle

- Pincés à tôle

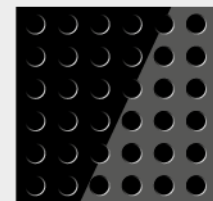

☞ 320 - 321

Poteaux

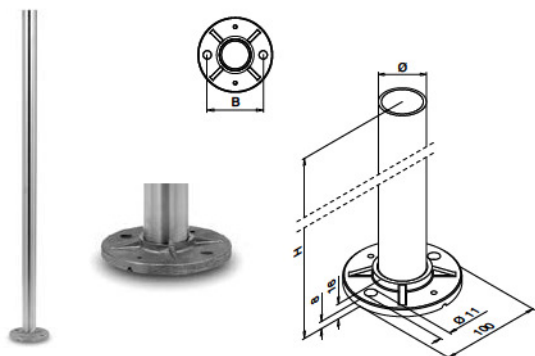

MOD 0921

V2A	304	Inox brossé				
INDOOR*			Ø	H	B	Accessories
	130921-242-12		42,4 x 2,0	989	75	QS-59 369 1
	130921-248-12		48,3 x 2,0	989	80	QS-59 369 1
V4A	316	Inox brossé				
OUTDOOR			Ø	H	B	Accessories
	140921-242-12		42,4 x 2,0	989	75	QS-58 369 1
	140921-248-12		48,3 x 2,0	989	80	QS-58 369 1
V4A	316	Poli miroir				
OUTDOOR			Ø	H	B	Accessories
NEW	140921-242-10		42,4 x 2,0	989	75	QS-58 369 1

MOD 0914

V2A	304	Inox brossé				
INDOOR*			Ø	H	B	Accessories
SELL OUT	130914-242-12		42,4 x 2,0	970	75	QS-59 369 1
SELL OUT	130914-042-12		42,4 x 2,6	970	75	QS-59 369 1
V4A	316	Inox brossé				
OUTDOOR			Ø	H	B	Accessories
SELL OUT	140914-048-12		48,3 x 2,6	970	80	QS-58 369 1

MOD 0944

V4A	316	Inox brossé				
OUTDOOR			Ø	H	B	Accessories
	140944-242-12		42,4 x 2,0	1150	75	QS-58 369 1
	140944-248-12		48,3 x 2,0	1150	80	QS-58 369 1

PREFIX

Cache embases

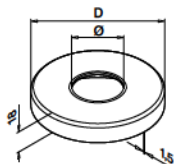

MOD 0512

V2A	304	Inox brossé			
INDOOR*			Ø	D	Accessories
	130512-042-12		42,4	105	2
	130512-048-12		48,3	105	2
V4A	316	Inox brossé			
OUTDOOR			Ø	D	Accessories
	140512-042-12		42,4	105	2
	140512-048-12		48,3	105	2
V4A	316	Poli miroir			
OUTDOOR			Ø	D	Accessories
	140512-042-10		42,4	105	2

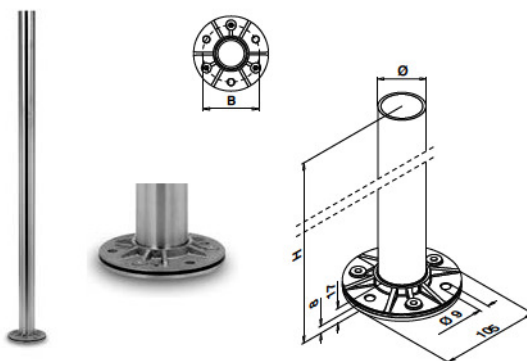

MOD 0912

V2A	304	Inox brossé				
INDOOR*			Ø	H	B	Accessories
	130912-242-12		42,4 x 2,0	989	80	QS-35 369 1
V4A	316	Inox brossé				
OUTDOOR			Ø	H	B	Accessories
	140912-242-12		42,4 x 2,0	989	80	QS-34 369 1
SELL OUT	140912-042-12		42,4 x 2,6	989	80	QS-34 369 1



Cache embases

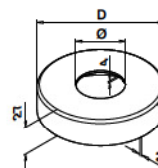

MOD 0511

V2A	304	Inox brossé			
INDOOR*			Ø	D	Accessories
	130511-042-12		42,4	110	2
V4A	316	Inox brossé			
OUTDOOR			Ø	D	Accessories
	140511-042-12		42,4	110	2
	140511-048-12		48,3	120	2

* Aussi pour l'extérieur dans des conditions physico-chimiques normales.



Seulement jusqu'à épuisement des stocks.

Q-INFO MOD 0912 / 0914

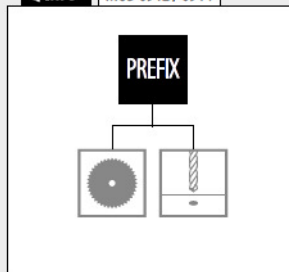

Q-INFO MOD 0912 / 0914



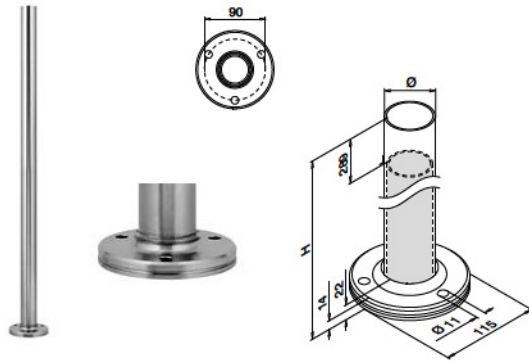

MOD 0916 - DOUBLE ÉPAISSEUR 4,6 mm

V2A	304	Inox brossé			
	INDOOR*	Ø	H		
	130916-548-12	48,3 x 4,6	989	QS-272	366

V4A	316	Inox brossé			
	OUTDOOR	Ø	H		
	140916-548-12	48,3 x 4,6	989	QS-273	366



	MOD 0713		MOD 0721		MOD 0773
	248		250		255

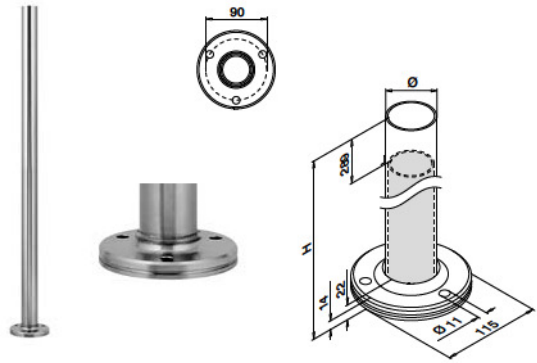

MOD 0917 - DOUBLE ÉPAISSEUR 4,6 mm

V4A	316	Inox brossé			
	OUTDOOR	Ø	H		
	140917-548-12	48,3 x 4,6	1089	QS-273	366



Poteaux

Cache embases



MOD 0511

V2A	304	Inox brossé			
	INDOOR*	Ø	D		
	130511-048-12	48,3	120		2

V4A	316	Inox brossé			
	OUTDOOR	Ø	D		
	140511-048-12	48,3	120		2

Q-INFO

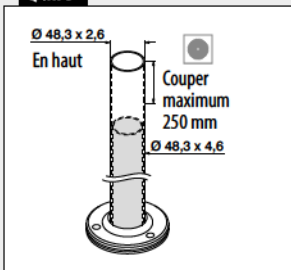

Q-INFO

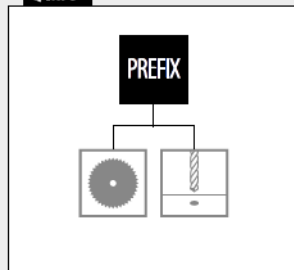

Q-INFO

MOD 0916 / 0917 / 0511



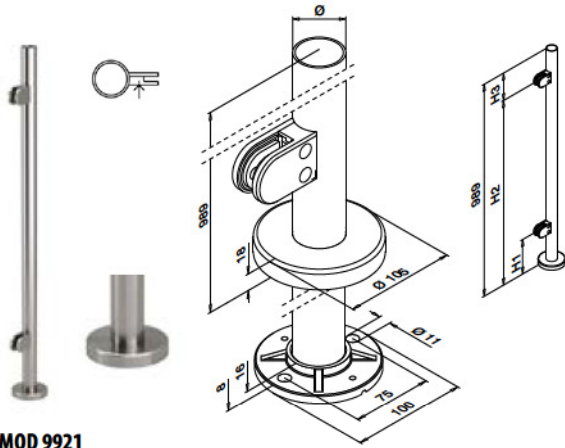

MOD 9921

V2A	304	Inox brossé						
	INDOOR*	Ø	H1	H2	H3			
	139921-242-01-12	42,4 x 2,0	175	869	120	QS-59	369	2

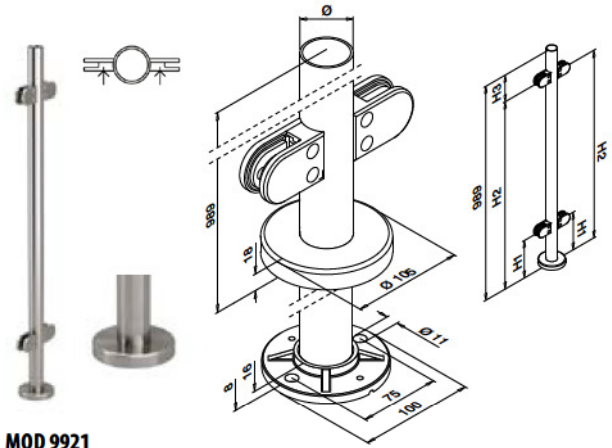

MOD 9921

V2A	304	Inox brossé						
	INDOOR*	Ø	H1	H2	H3			
	139921-242-02-12	42,4 x 2,0	175	869	120	QS-59	369	1

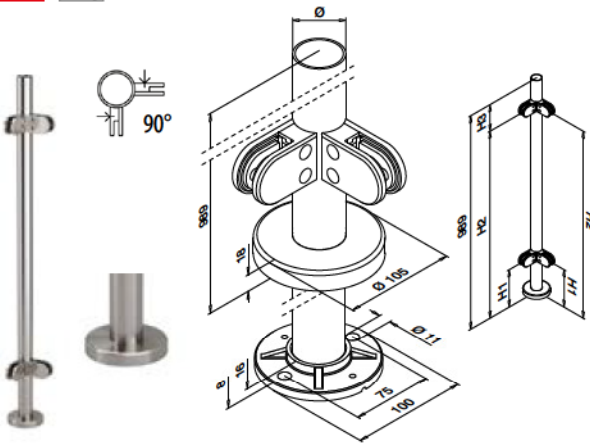

MOD 9921

V2A	304	Inox brossé						
	INDOOR*	Ø	H1	H2	H3			
	139921-242-90-12	42,4 x 2,0	175	869	120	QS-59	369	1



Remplissage

Cales caoutchouc pour pinces à verre MOD 2500



2 pièces par pince à verre

MOD 5025

Accessoires

Mono	T	
205025-06	6	8
205025-08	8	8
205025-10	10	8
205025-12	12	8

Feuilleté	T	
205025-07	6,76 (3-0,76-3)	8
205025-09	8,76 (4-0,76-4)	8
205025-11	10,76 (5-0,76-5)	8
205025-13	12,76 (6-0,76-6)	8

Accessoires

Goupilles de sécurité

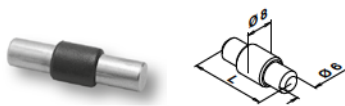

Optionnel pour MOD 2500

MOD 5015

Accessoires

	L	
205015-25	25	4



MOD 0710
248, 249
MOD 0718
250

* Aussi pour l'extérieur dans des conditions physico-chimiques normales.

Q-INFO MOD 5015

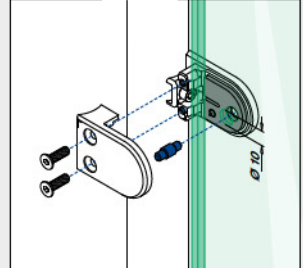

Q-INFO

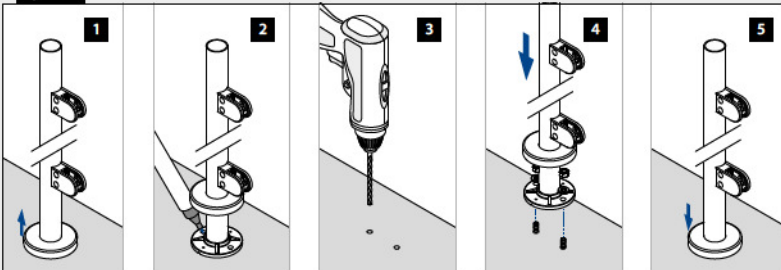

Q-INFO

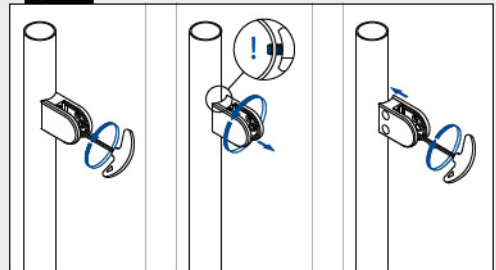

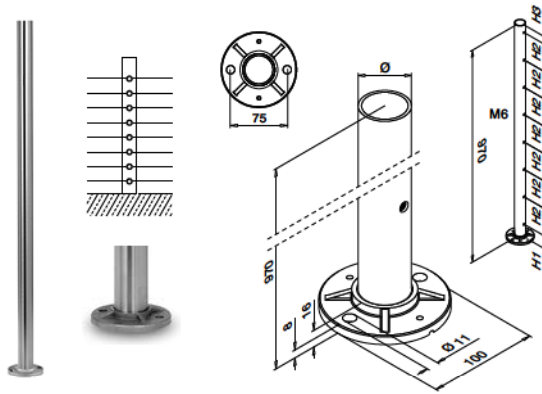

MOD 0930

V2A	304	Inox brossé					
	INDOOR*	Ø	H1	H2	H3		
SELL OUT	130930-242-00-12	42,4 x 2,0	60	125	35	QS-59	369 1

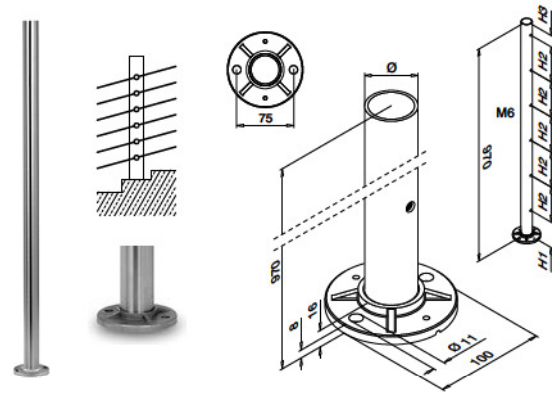

MOD 0930

V2A	304	Inox brossé					
	INDOOR*	Ø	H1	H2	H3		
SELL OUT	130930-242-01-12	42,4 x 2,0	125	160	45	QS-59	369 1

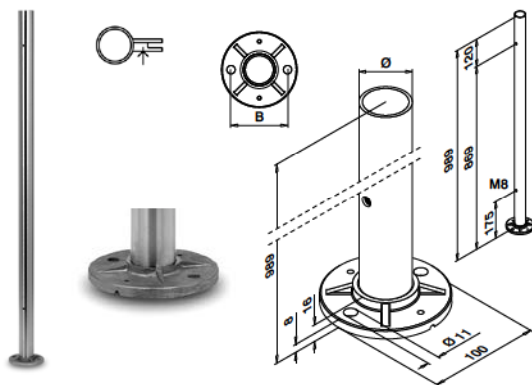

MOD 0962

V4A	316	Inox brossé					
	OUTDOOR	Ø	B				
	140962-242-01-12	42,4 x 2,0	75	QS-58	369	1	
	140962-248-01-12	48,3 x 2,0	80	QS-58	369	1	

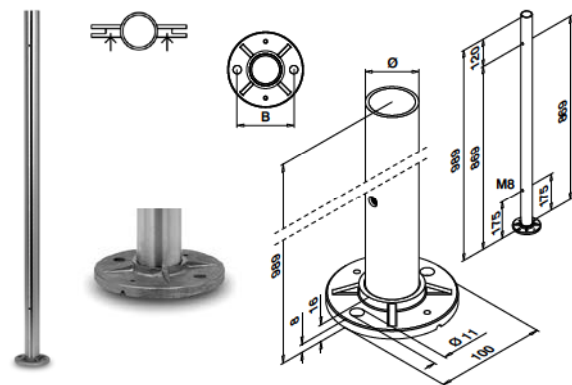

MOD 0962

V4A	316	Inox brossé					
	OUTDOOR	Ø	B				
	140962-242-02-12	42,4 x 2,0	75	QS-58	369	1	
	140962-248-02-12	48,3 x 2,0	80	QS-58	369	1	

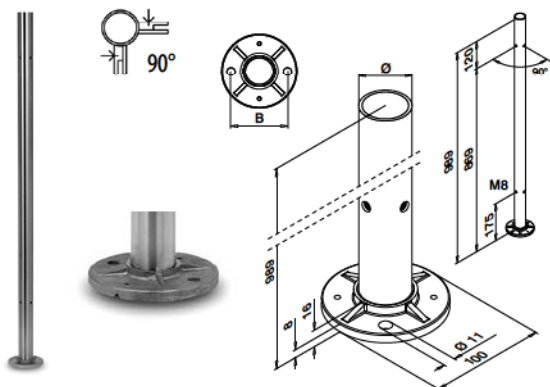

MOD 0962

V4A	316	Inox brossé					
	OUTDOOR	Ø	B				
	140962-242-90-12	42,4 x 2,0	75	QS-58	369	1	
	140962-248-90-12	48,3 x 2,0	80	QS-58	369	1	

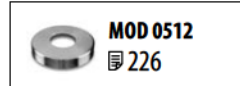

SELL OUT Seulement jusqu'à épuisement des stocks.

Q-INFO MOD 0930 / 0962

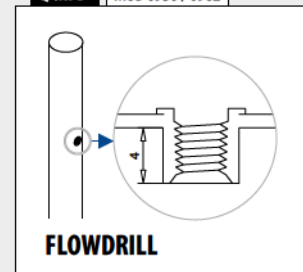

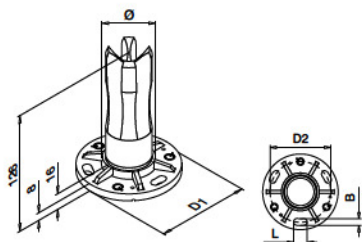

MOD 0942

V2A 304 Inox brossé

INDOOR*	Ø	D1	D2	B x L	Q5-35	369	2
130942-233	33,7 x 2,0	100	80	9x28	Q5-35	369	2
130942-242	42,4 x 2,0	100	80	9x28	Q5-35	369	2
130942-248	48,3 x 2,0	100	80	9x28	Q5-35	369	2
130942-060	60,3 x 2,0	120	90	11x30	Q5-35	369	2

V4A 316 Inox brossé

OUTDOOR	Ø	D1	D2	B x L	Q5-34	369	2
140942-233	33,7 x 2,0	100	80	9x28	Q5-34	369	2
140942-242	42,4 x 2,0	100	80	9x28	Q5-34	369	2
140942-248	48,3 x 2,0	100	80	9x28	Q5-34	369	2

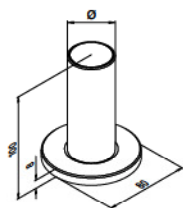

Cache-embase inutile

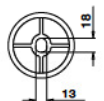

MOD 0946

V2A 304 Inox brossé

INDOOR*	Ø	Q5-33	366	2
130946-242-12	42,4 x 2,0	Q5-33	366	2

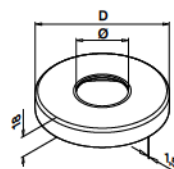
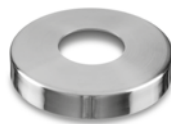

MOD 0512

V2A 304 Inox brossé

INDOOR*	Ø	D	2
130512-033-12	33,7	105	2
130512-042-12	42,4	105	2
130512-048-12	48,3	105	2

V4A 316 Inox brossé

OUTDOOR	Ø	D	2
140512-033-12	33,7	105	2
140512-042-12	42,4	105	2
140512-048-12	48,3	105	2

MOD 0513

V2A 304 Inox brossé

INDOOR*	Ø	D	2
130513-042-12	42,4	125	2
130513-048-12	48,3	125	2
130513-060-12	60,3	125	2

V4A 316 Inox brossé

OUTDOOR	Ø	D	2
140513-042-12	42,4	125	2
140513-048-12	48,3	125	2

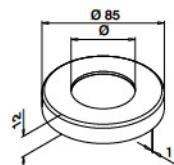
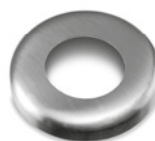

MOD 0516

V2A 304 Inox brossé

INDOOR*	Ø	2
130516-033	33,7	2
130516-042	42,4	2

Q-INFO MOD 0942

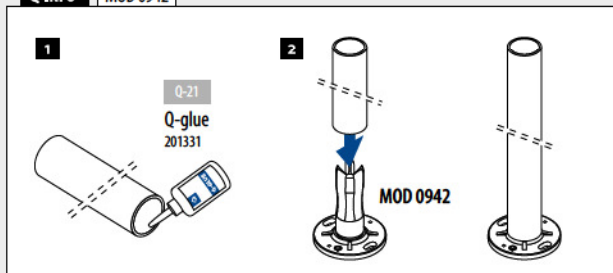

Q-INFO MOD 0946

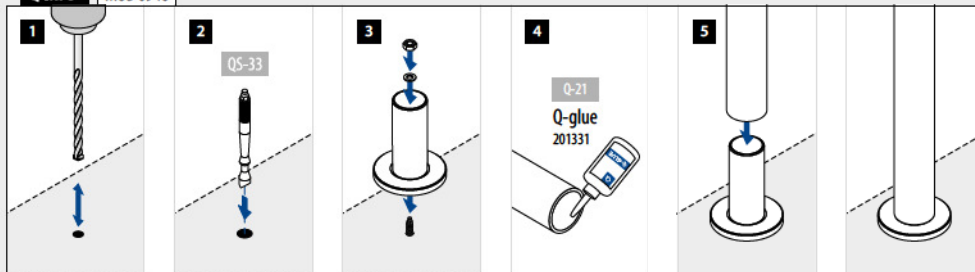

* Aussi pour l'extérieur dans des conditions physico-chimiques normales.

SELL OUT Seulement jusqu'à épuisement des stocks.

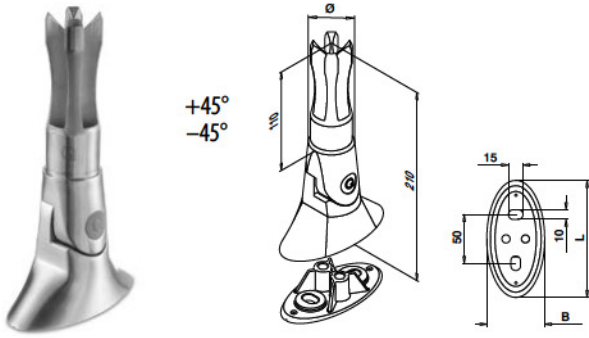

MOD 0945

V2A	304	Inox brossé				
INDOOR*			Ø	B	L	
130945-242	42,4 x 2,0	59	118	QS-65	366	1
130945-248	48,3 x 2,0	65	118	QS-65	366	1
V4A	316	Inox brossé				
OUTDOOR			Ø	B	L	
140945-242	42,4 x 2,0	59	118	QS-64	366	1



Tubes prédécoupés

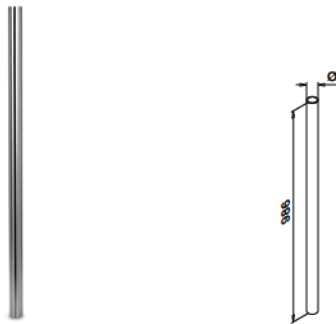

MOD 0901

V2A	304	Inox brossé		
INDOOR*		Ø		
130901-242-12	42,4 x 2,0	1		



Q-INFO MOD 0901

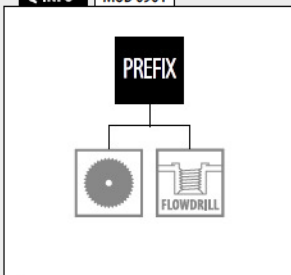

Q-INFO MOD 0945

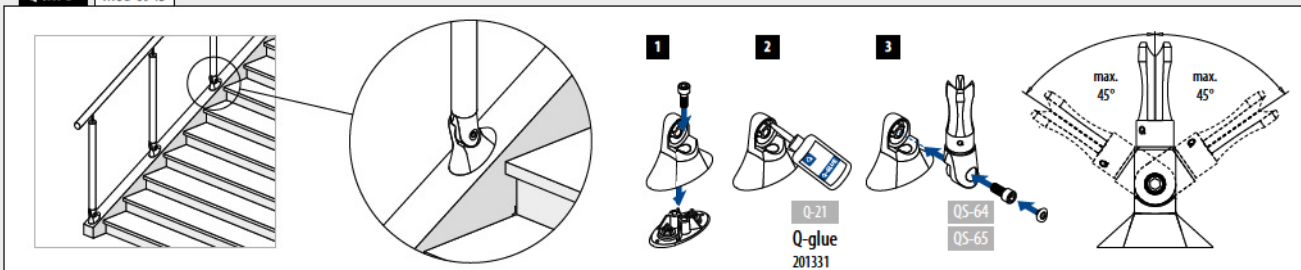

Support mural pour poteau

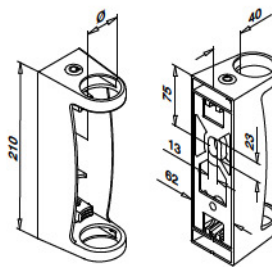
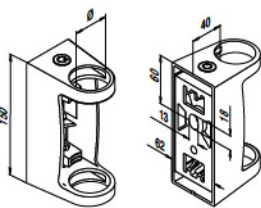

MOD 0557

V2A	304	Inox brossé		
INDOOR*				
130557-042-12	42,4	QS-33	366	1
130557-048-12	48,3	QS-33	366	1
V4A				
316 Inox brossé				
OUTDOOR				
140557-042-12	42,4	QS-32	366	1
140557-048-12	48,3	QS-32	366	1



International Design Modèle Protection

MOD 0558

V2A	304	Inox brossé		
INDOOR*				
130558-048-12	48,3	QS-33	366	1
V4A				
316 Inox brossé				
OUTDOOR				
NEW 140558-048-12	48,3	QS-275	366	1



International Design Modèle Protection

Support mural pour poteau

Angle ajustable

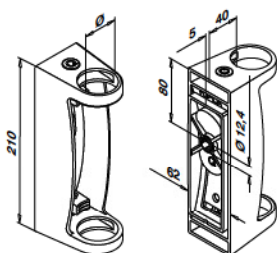

MOD 0556

V2A	304	Inox brossé		
INDOOR*				
130556-042	42,4	QS-505	367 / QS-551	376
				1



International Design Modèle Protection

Q-INFO MOD 0556

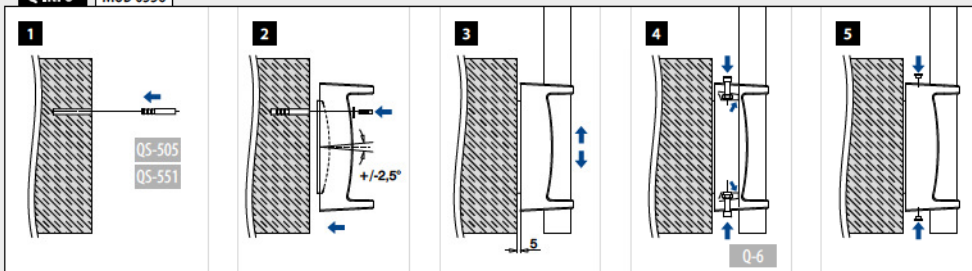

Q-INFO MOD 0557 / 0558

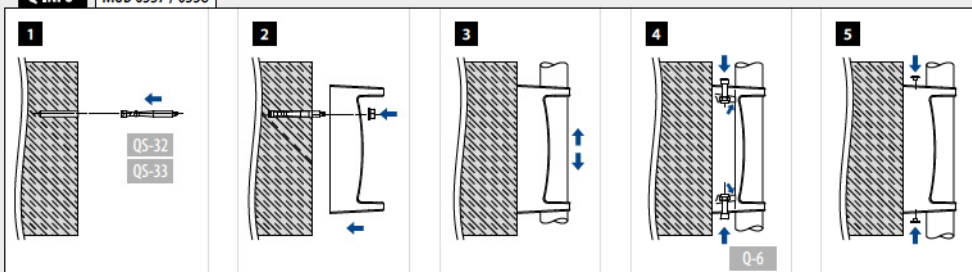

Support mural pour poteau

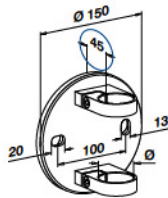

MOD 0551

V2A	304	Inox brossé			
	INDOOR*	Ø			
	130551-042-12	42,4	Ø5-33	366	1
V2A	304	Poli miroir			
	INDOOR*	Ø			
SELL OUT	130551-042-10	42,4	Ø5-33	366	1
V4A	316	Inox brossé			
	OUTDOOR	Ø			
	140551-042-12	42,4	Ø5-32	366	1
	140551-048-12	48,3	Ø5-32	366	1
V4A	316	Poli miroir			
	OUTDOOR	Ø			
	140551-042-10	42,4	Ø5-32	366	1

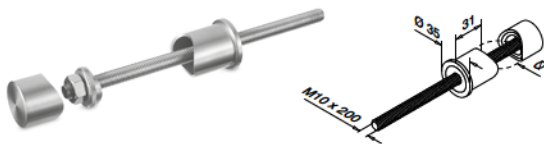

MOD 0550

V2A	304	Inox brossé			
	INDOOR*	Ø			
	130550-042-12	42,4			2
	130550-048-12	48,3			2
V4A	316	Inox brossé			
	OUTDOOR	Ø			
	140550-042-12	42,4			2
	140550-048-12	48,3			2

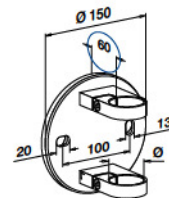

MOD 0552

V2A	304	Inox brossé			
	INDOOR*	Ø			
SELL OUT	130552-042-12	42,4	Ø5-33	366	1
V4A	316	Inox brossé			
	OUTDOOR	Ø			
	140552-042-12	42,4	Ø5-32	366	1
	140552-048-12	48,3	Ø5-32	366	1



Support mural pour poteau



Angle rentrant et sortant

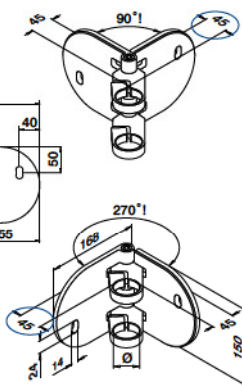
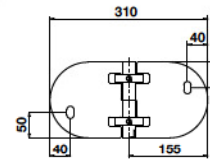

MOD 0555

V2A	304	Inox brossé			
	INDOOR*	Ø			
	130555-042-12	42,4	Ø5-33	366	1
V4A	316	Inox brossé			
	OUTDOOR	Ø			
	140555-042-12	42,4	Ø5-32	366	1
	140555-048-12	48,3	Ø5-32	366	1
V4A	316	Poli miroir			
	OUTDOOR	Ø			
	140555-042-10	42,4	Ø5-32	366	1



* Aussi pour l'extérieur dans des conditions physico-chimiques normales.

SELL OUT Seulement jusqu'à épaisseur des stocks.

Q-INFO MOD 0551 / 0552 / 0555

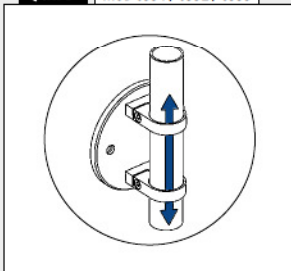

Q-INFO MOD 0550



Q-INFO MOD 0550

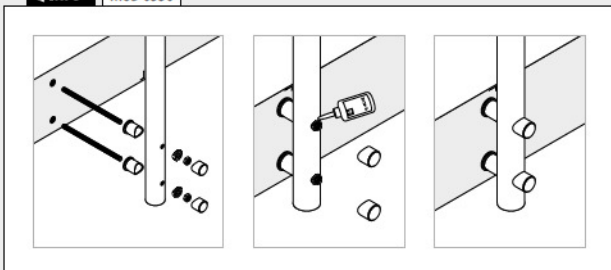

Q-INFO MOD 0551 / 0552

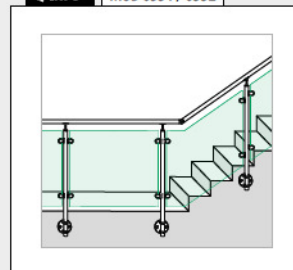

Q-INFO MOD 1035



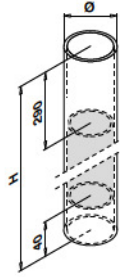

MOD 0951 - DOUBLE ÉPAISSEUR 4,6 mm

V2A	304	Inox brossé		
	INDOOR*		Ø	H
130951-548-12	48,3 x 4,6			1
V4A	316	Inox brossé		
	OUTDOOR		Ø	H
140951-548-12	48,3 x 4,6			1

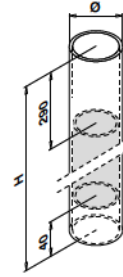
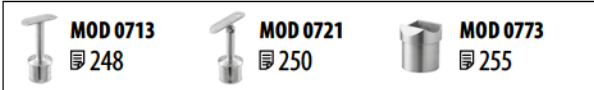
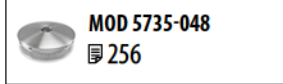

MOD 0952 - DOUBLE ÉPAISSEUR 4,6 mm

V2A	304	Inox brossé		
	INDOOR*		Ø	H
130952-548-12	48,3 x 4,6			1
V4A	316	Inox brossé		
	OUTDOOR		Ø	H
140952-548-12	48,3 x 4,6			1



SYSTÈMES DE GARDE-CORPS À POTEAUX

Q-LINE - EXTRA FORT

Q-INFO

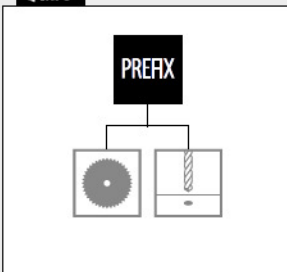

Q-INFO MOD 0951 / 0952

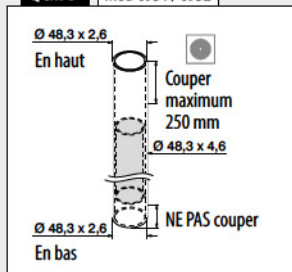

Q-INFO MOD 0951 / 0952

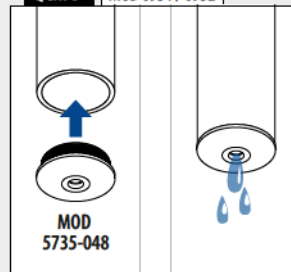

* Aussi pour l'extérieur dans des conditions physico-chimiques normales.

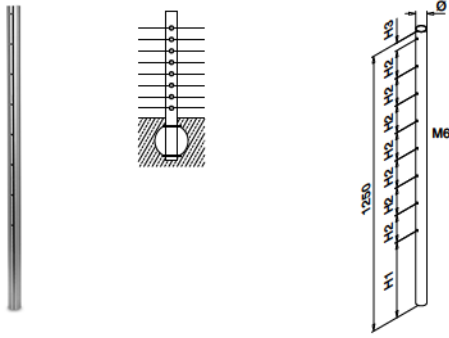

MOD 0935

V2A	304	Inox brossé				
INDOOR*		Ø	H1	H2	H3	
130935-242-00-12	42,4 x 2,0	340	125	35	1	

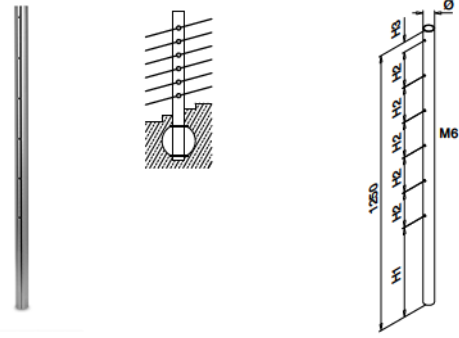

MOD 0935

V2A	304	Inox brossé				
INDOOR*		Ø	H1	H2	H3	
130935-242-01-12	42,4 x 2,0	405	160	45	1	

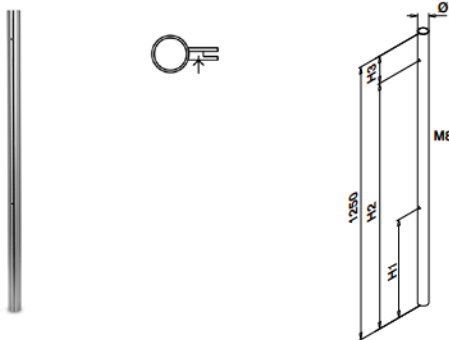

MOD 0937

V2A	304	Inox brossé				
INDOOR*		Ø	H1	H2	H3	
130937-242-01-12	42,4 x 2,0	455	1130	120	1	

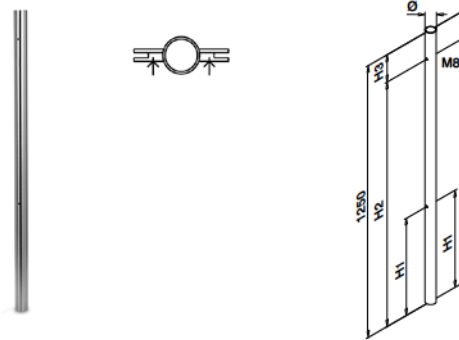

MOD 0937

V2A	304	Inox brossé				
INDOOR*		Ø	H1	H2	H3	
130937-242-02-12	42,4 x 2,0	455	1130	120	1	

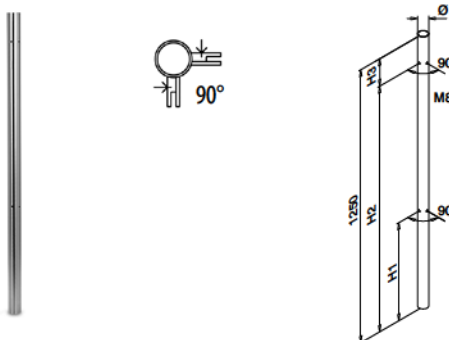

MOD 0937

V2A	304	Inox brossé				
INDOOR*		Ø	H1	H2	H3	
130937-242-90-12	42,4 x 2,0	455	1130	120	1	



	MOD 5735-242 256		MOD 5736-242 256
--	----------------------------	--	----------------------------

	MOD 0710 248		MOD 0718 250		MOD 0725, MOD 0770 255
--	------------------------	--	------------------------	--	----------------------------------

	MOD 055x 232, 233
--	-----------------------------

Q-INFO MOD 0935 / 0937

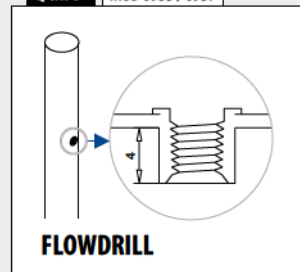

Poteaux

Poteaux

Pour marches flottantes

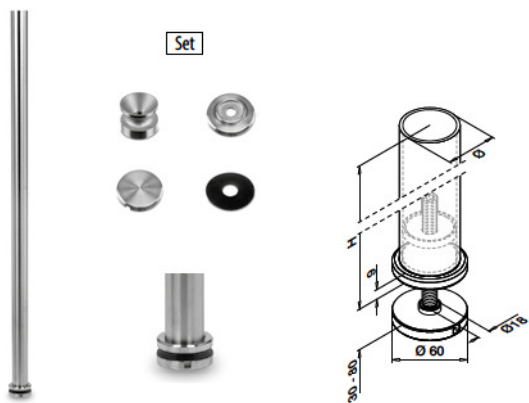

MOD 0545

V2A	304	Inox brossé		
INDOOR*		Ø	H	
130545		42,4 x 2,0	1150	1

PREFIX ?

Poteaux

Embases-manchons

Fixation traversante

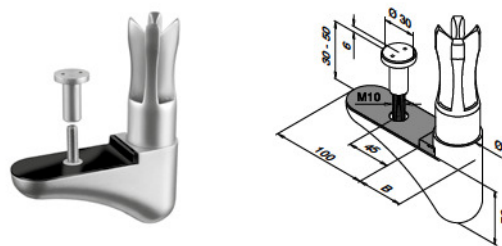

MOD 0947

V2A	304	Inox brossé		
INDOOR*		Ø	B	
130947-242		42,4 x 2,0	48	1



International Design Modèle Protection



MOD 0947

Q-INFO MOD 0545

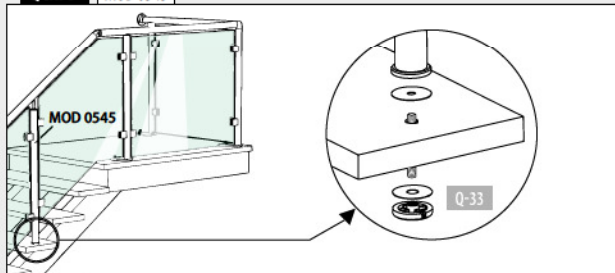

Q-INFO MOD 0947

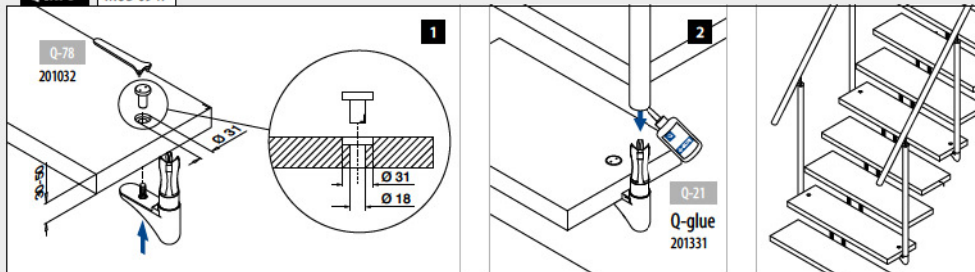

Q-INFO MOD 0545

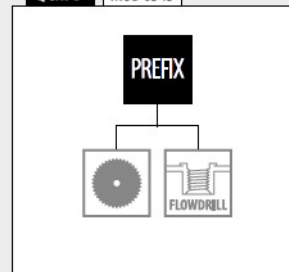

Support mural pour poteau

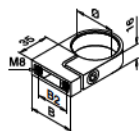

MOD 3507

V2A	304	Inox brossé				
INDOOR*		Ø	B	B2		
133507-033-12		33,7	45	30	2	
133507-042-12		42,4	50	35	2	
133507-048-12		48,3	55	35	2	
V4A	316	Inox brossé				
OUTDOOR		Ø	B	B2		
143507-042-12		42,4	50	35	2	
143507-048-12		48,3	55	35	2	



Insert à souder

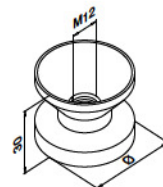

MOD 3501

V2A	304	Brut		
INDOOR*		Ø		
133501-242		42,4 x 2,0	QS-274	366 2
133501-042		42,4 x 2,6	QS-274	366 2

SELL OUT



Rondelle de calage

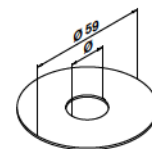

MOD 5080 / 5081

Accessoires		
	Ø	
205080	18	20
205081	12	20

Rosace

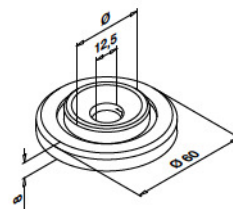

MOD 0501

V2A	304	Inox brossé		
INDOOR*		Ø		
130501-042		42,4 x 2,0 + 42,4 x 2,6		2

Cache embases

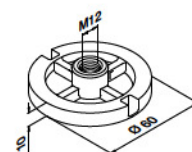

MOD 0731

V2A	304	Inox brossé		
INDOOR*				
130731				2



* Aussi pour l'extérieur dans des conditions physico-chimiques normales.

Seulement jusqu'à épuisement des stocks.

Q-INFO MOD 3507

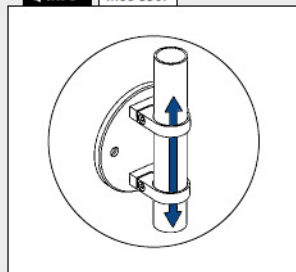

Q-INFO MOD 3501

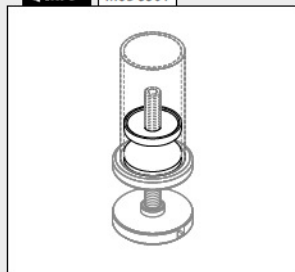

Mur - plat

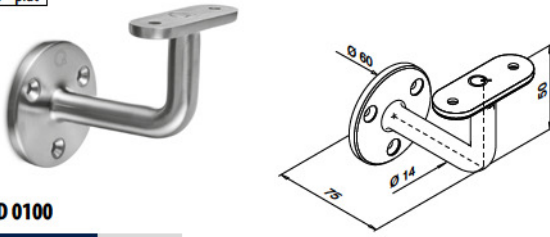

MOD 0100

V2A	304	Inox brossé		
INDOOR*				
130100-000-12	QS-7	375 / QS-12	376 / QS-87	374 2
V4A	316	Inox brossé		
OUTDOOR				
140100-000-12	QS-50	375 / QS-13	376 / QS-87	374 2



Mur - tube

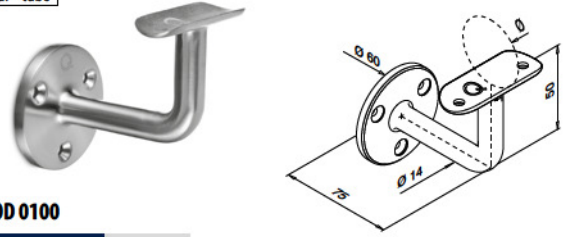

MOD 0100

V2A	304	Inox brossé			
INDOOR*					
130100-042-12	42,4	QS-7	375 / QS-10	376 / QS-87	374 2
130100-048-12	48,3	QS-7	375 / QS-10	376 / QS-87	374 2
V4A	316	Inox brossé			
OUTDOOR					
140100-042-12	42,4	QS-50	375 / QS-11	376 / QS-87	374 2
140100-048-12	48,3	QS-50	375 / QS-11	376 / QS-87	374 2



Mur - plat

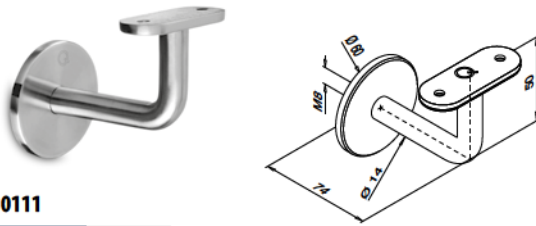

MOD 0111

V2A	304	Inox brossé		
INDOOR*				
130111-000-12	QS-12	376		2
V4A	316	Inox brossé		
OUTDOOR				
140111-000-12	QS-13	376		2



Mur - tube

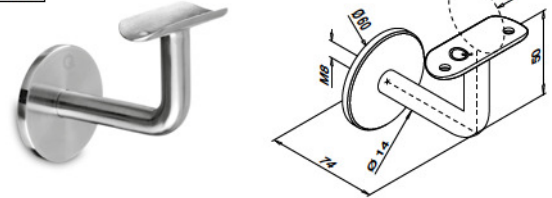

MOD 0111

V2A	304	Inox brossé		
INDOOR*				
130111-033-12	33,7	QS-10	375	2
130111-042-12	42,4	QS-10	375	2
130111-048-12	48,3	QS-10	375	2
V2A	304	Poli miroir		
INDOOR*				
SELL OUT 130111-042-10	42,4	QS-10	375	2
V4A	316	Inox brossé		
OUTDOOR				
140111-042-12	42,4	QS-11	376	2
140111-048-12	48,3	QS-11	376	2
V4A	316	Poli miroir		
OUTDOOR				
140111-042-10	42,4	QS-11	376	2



Q-INFO MOD 0100 / 0111

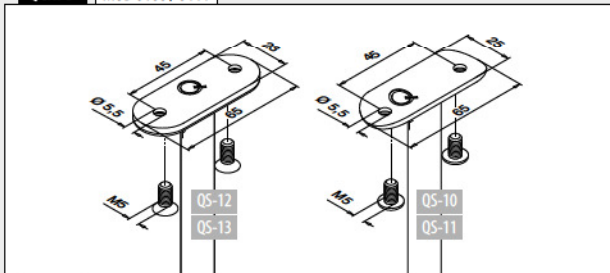

* Aussi pour l'extérieur dans des conditions physico-chimiques normales.



SELL OUT Seulement jusqu'à épuisement des stocks.

Q-INFO MOD 0111

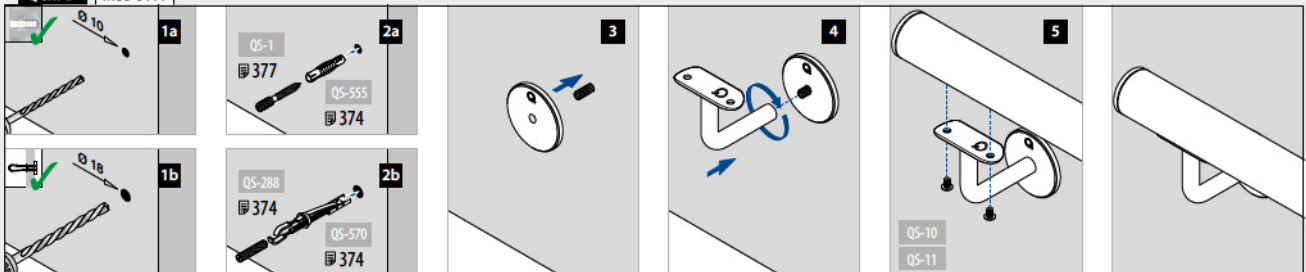

Mur - tube

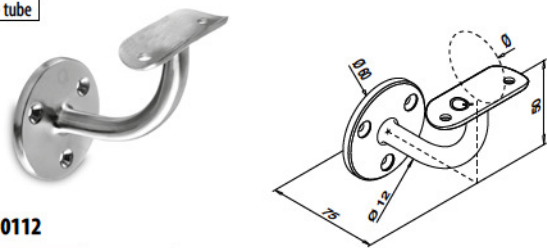

MOD 0112

V2A	304	Inox brossé				
INDOOR*						
130112-033-12	33,7	QS-7	375 / QS-10	375 / QS-87	374	2
130112-042-12	42,4	QS-7	375 / QS-10	375 / QS-87	374	2
130112-048-12	48,3	QS-7	375 / QS-10	375 / QS-87	374	2

V2A	304	Poli miroir				
INDOOR*						
130112-042-10	42,4	QS-7	375 / QS-10	375 / QS-87	374	2

V4A	316	Inox brossé				
OUTDOOR						
140112-042-12	42,4	QS-50	375 / QS-11	376 / QS-87	374	2

V4A	316	Poli miroir				
OUTDOOR						
140112-042-10	42,4	QS-50	375 / QS-11	376 / QS-87	374	2

	Zamak	Aspect inox brossé				
INDOOR						
100112-042	42,4	QS-7	375 / QS-10	375 / QS-87	374	2



Mur - tube

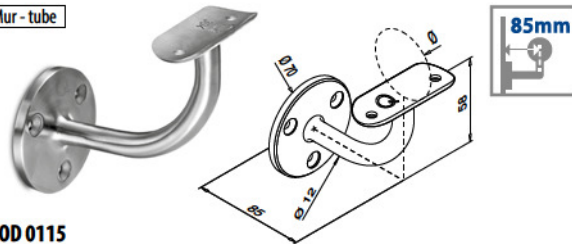

MOD 0115

V2A	304	Inox brossé				
INDOOR*						
130115	42,4	QS-7	375 / QS-10	375 / QS-87	374	2



Mur - plat

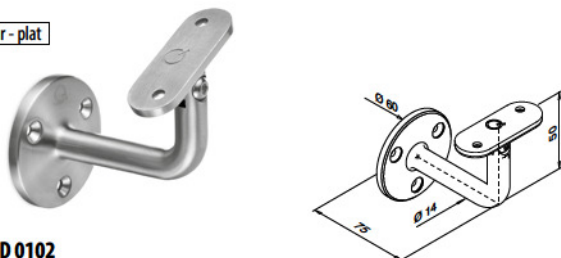

MOD 0102

V2A	304	Inox brossé				
INDOOR*						
130102-000-12		QS-7	375 / QS-12	376 / QS-87	374	2



Mur - tube

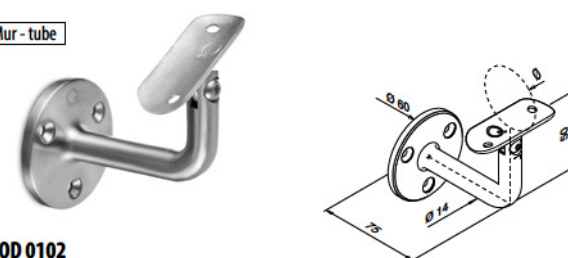

MOD 0102

V2A	304	Inox brossé				
INDOOR*						
130102-042-12	42,4	QS-7	375 / QS-10	375 / QS-87	374	2
130102-048-12	48,3	QS-7	375 / QS-10	375 / QS-87	374	2

V4A	316	Inox brossé				
OUTDOOR						
140102-042-12	42,4	QS-50	375 / QS-11	376 / QS-87	374	2
140102-048-12	48,3	QS-50	375 / QS-11	376 / QS-87	374	2



Q-INFO MOD 0102

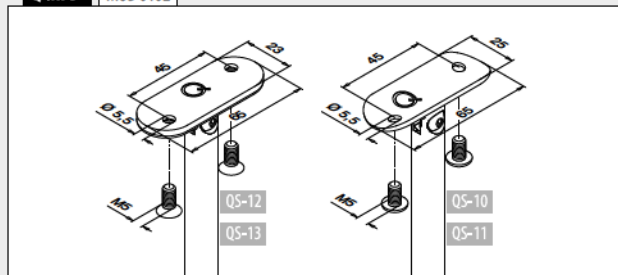

Q-INFO MOD 0112 / 0115

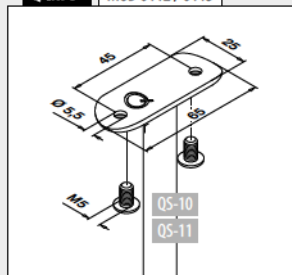

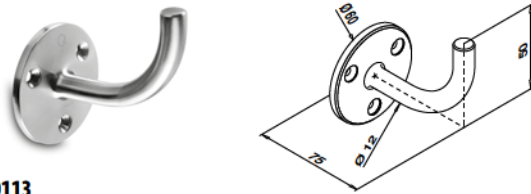

MOD 0113

V2A	304	Inox brossé		
	INDOOR*			
130113	QS-7	375 / QS-87	374	2
V4A	316	Inox brossé		
	OUTDOOR			
140113	QS-50	375 / QS-87	374	2

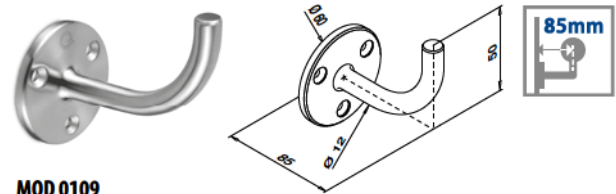

MOD 0109

V2A	304	Inox brossé		
	INDOOR*			
130109	QS-7	375 / QS-87	374	2

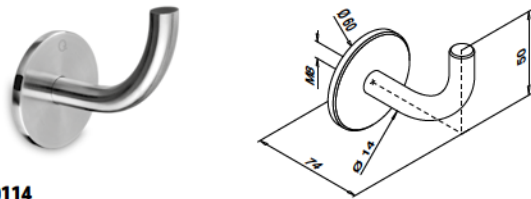

MOD 0114

V2A	304	Inox brossé		
	INDOOR*			
SELL OUT 130114	QS-1	377		2
V4A	316	Inox brossé		
	OUTDOOR			
SELL OUT 140114	QS-2	375		2

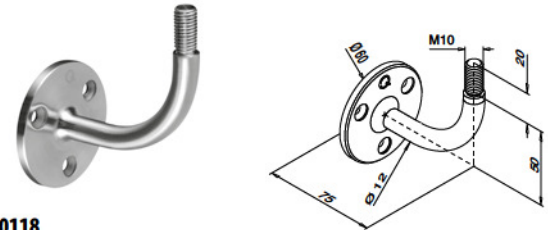

MOD 0118

V2A	304	Inox brossé		
	INDOOR*			
130118	QS-7	375 / QS-87	374	2



MOD 0519

V4A	316	Inox brossé		
	OUTDOOR			
140519				2
	Zamak	Aspect inox brossé		
	INDOOR			
SELL OUT 100519				2

* Aussi pour l'extérieur dans des conditions physico-chimiques normales.

Seulement jusqu'à épuisement des stocks.

Q-INFO MOD 0118



Q-INFO MOD 0519

Pour MOD 0109,
0118 et 0113



Mur - plat

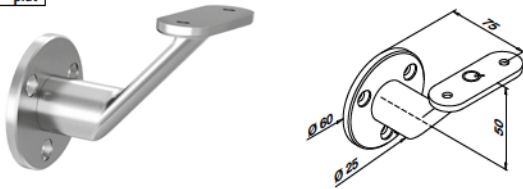

MOD 0126

V2A	304	Inox brossé		
INDOOR*				
	130126-000-12	Ø 376	2	
V4A	316	Inox brossé		
OUTDOOR				
	140126-000-12	Ø 376	2	

NEW



International Design Modèle Protection

Mur - tube

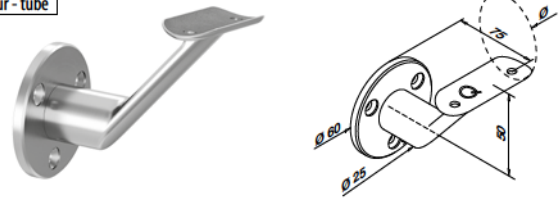

MOD 0126

V2A	304	Inox brossé		
INDOOR*				
	130126-042-12	42,4	Ø 375	2
	130126-048-12	48,3	Ø 375	2
V4A	316	Inox brossé		
OUTDOOR				
	140126-042-12	42,4	Ø 376	2

NEW



Caches

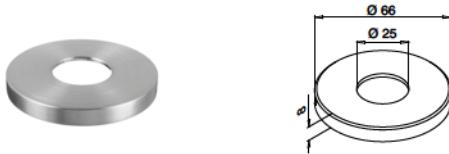

MOD 0520

V2A	304	Inox brossé		
INDOOR*				
	130520-12		2	
V4A	316	Inox brossé		
OUTDOOR				
	140520-12		2	

Mur - tube

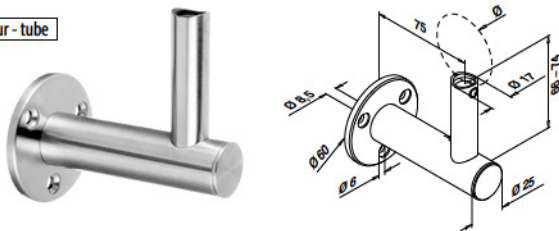

MOD 0142

V2A	304	Inox brossé		
INDOOR*				
SELL OUT	130142-044-12	42,4 / 48,3	Ø 376	2
V4A	316	Inox brossé		
OUTDOOR				
SELL OUT	140142-044-12	42,4 / 48,3	Ø 376	2



Q-INFO MOD 0126

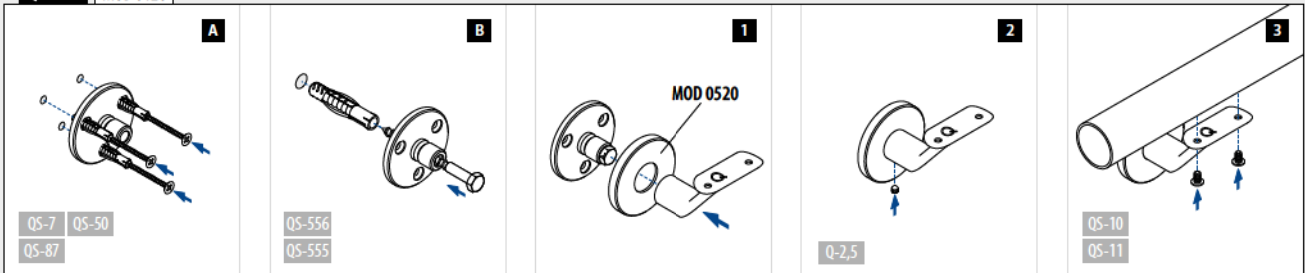

Q-INFO MOD 0142

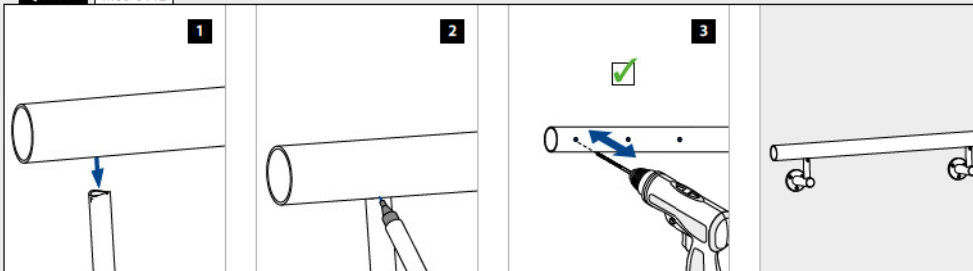

Q-INFO MOD 0520

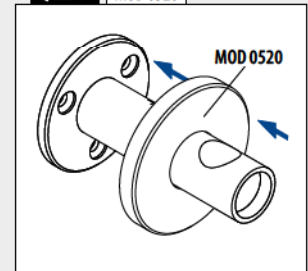

Q-INFO MOD 0142

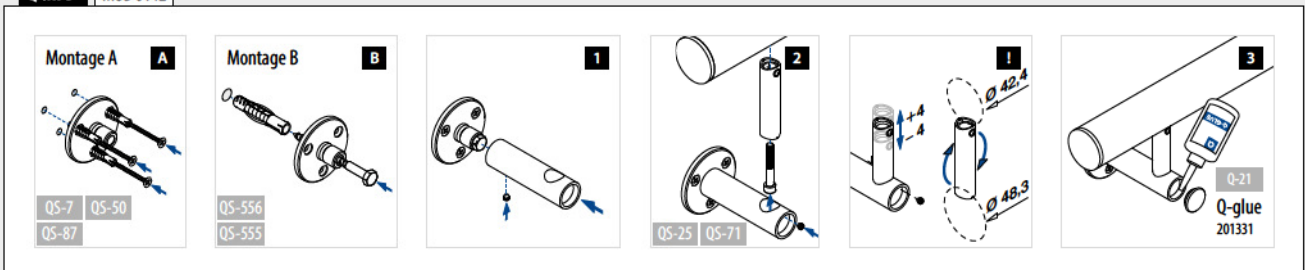

Mur - tube



MOD 0110

V4A	316	Inox brossé		
	OUTDOOR	Ø		
140110	42,4	QS-11	376	2



International Design Modèle Protection

Mur - tube

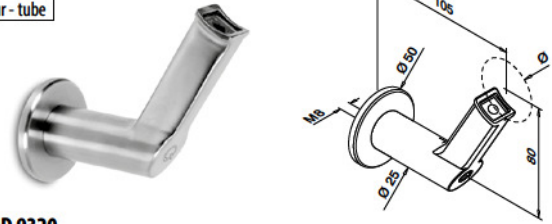

MOD 9320

V2A	304	Inox brossé		
	INDOOR*	Ø		
139320-042	42,4	QS-1	377 / QS-25	376
				2



MOD 0509

V4A	316	Inox brossé		
	OUTDOOR			
140509				2

International Design Modèle Protection

* Aussi pour l'extérieur dans des conditions physico-chimiques normales.

Q-INFO MOD 9320

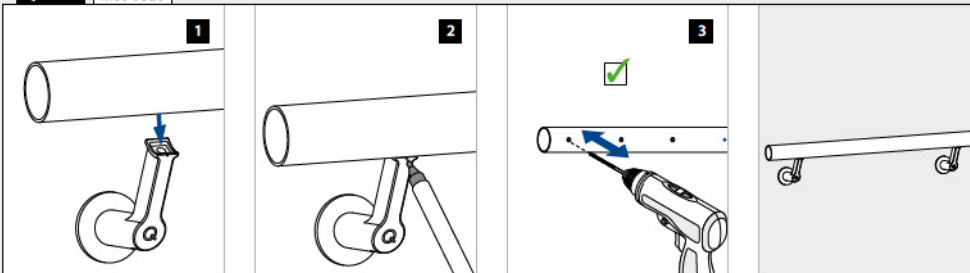

Q-INFO MOD 0110 / 0509

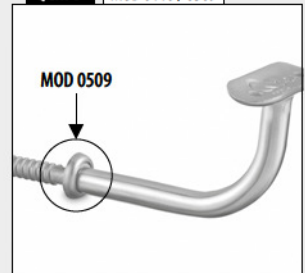

Q-INFO MOD 9320

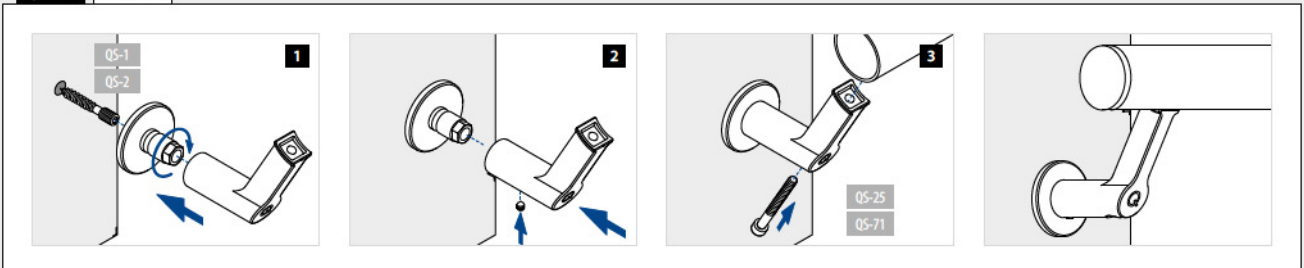

Entretoises

Plat - tube

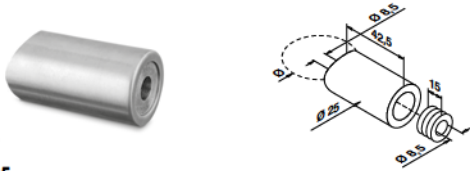

MOD 0625

V2A	304	Inox brossé				
INDOOR*		Ø				
130625-033-12	33,7	QS-3	QS-3	QS-29	376	4
130625-042-12	42,4	QS-3	QS-3	QS-29	376	4
V4A	316	Inox brossé				
OUTDOOR		Ø				
140625-042-12	42,4	QS-4	QS-3	QS-30	376	4



Tube - tube



MOD 0627

V2A	304	Inox brossé			
INDOOR*		D	Ø		
130627-042-12	42,4	42,4	QS-29	376	4



Supports de main-courante

Mur - plat

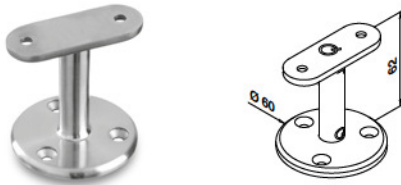

MOD 0708

V2A	304	Inox brossé				
INDOOR*		Ø				
130708-000-12		QS-5	QS-5	QS-12	376	2



Mur - tube



MOD 0708

V2A	304	Inox brossé				
INDOOR*		Ø				
130708-042-12	42,4	QS-5	QS-5	QS-10	375	2
130708-048-12	48,3	QS-5	QS-5	QS-10	375	2

V4A	316	Inox brossé				
OUTDOOR		Ø				
140708-042-12	42,4	QS-6	QS-6	QS-11	376	2
140708-048-12	48,3	QS-6	QS-6	QS-11	376	2



Q-INFO MOD 0708

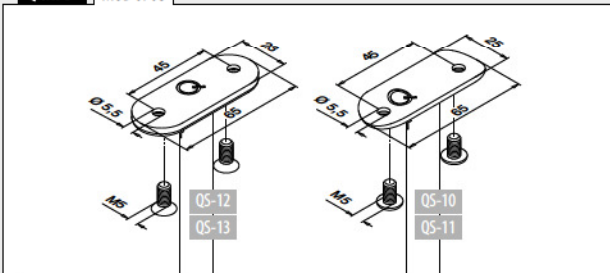

Q-INFO MOD 0625

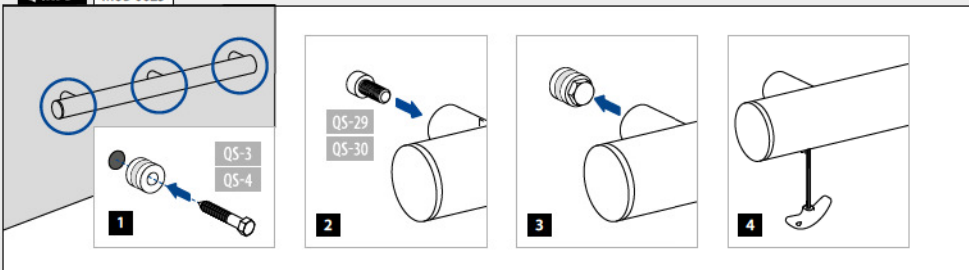

Q-INFO MOD 0627

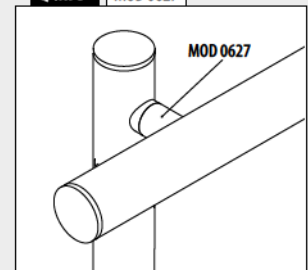

Verre - plat

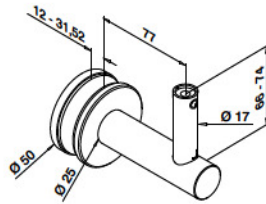

MOD 0148

V2A	304	Inox brossé		
	INDOOR*			
SELL OUT	130148-000-12	QS-24	376	2



International Design Modèle Protection

Verre - tube

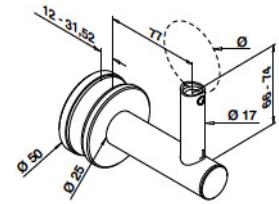

MOD 0148

V2A	304	Inox brossé		
	INDOOR*		Ø	
SELL OUT	130148-044-12	42,4 / 48,3	QS-25	376
V4A	316	Inox brossé		
	OUTDOOR		Ø	
SELL OUT	140148-044-12	42,4 / 48,3	QS-71	376



International Design Modèle Protection

Verre - tube

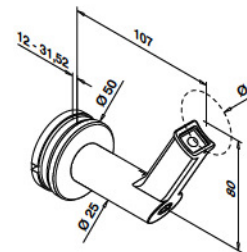

MOD 9350

V2A	304	Inox brossé		
	INDOOR*		Ø	
	139350-042	42,4	QS-25	376
	139350-048	48,3	QS-25	376
V4A	316	Inox brossé		
	OUTDOOR		Ø	
SELL OUT	149350-042	42,4	QS-71	376
SELL OUT	149350-048	48,3	QS-71	376



* Aussi pour l'extérieur dans des conditions physico-chimiques normales.

Seulement jusqu'à épuisement des stocks.

Q-INFO MOD 0148-044

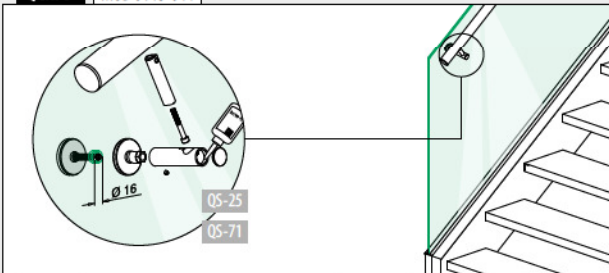

Q-INFO MOD 9350

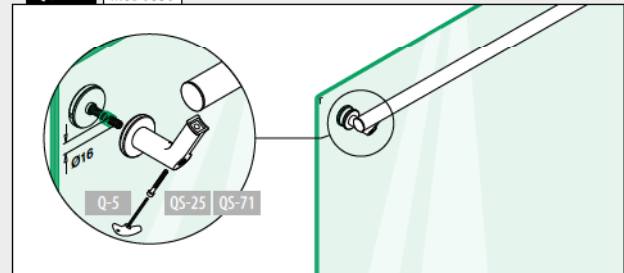

Q-INFO MOD 0148-044

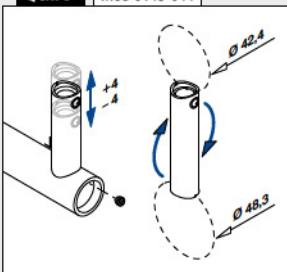

Q-INFO MOD 0148-044

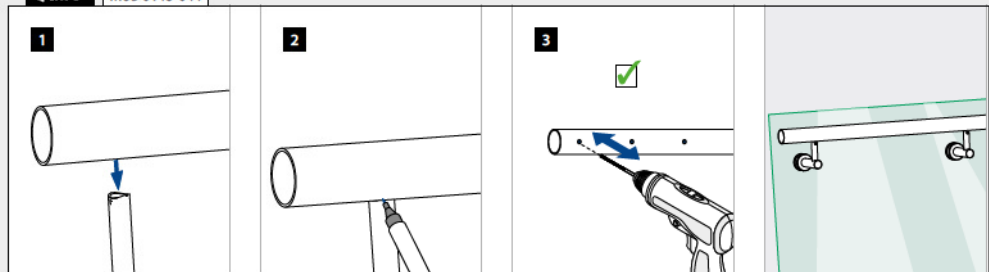

Verre - plat

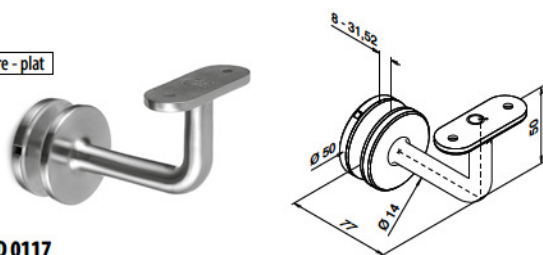

MOD 0117

V2A	304	Inox brossé		
INDOOR*				
130117-000-12		Ø	QS-12	376
				2
V4A				
316				
OUTDOOR				
140117-000-12		Ø	QS-13	376
				2



Verre - tube

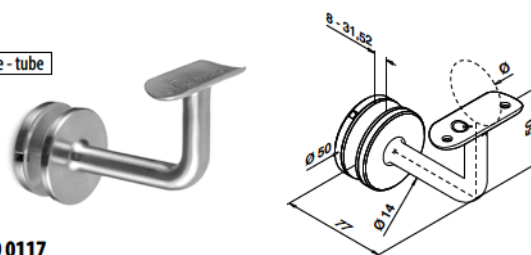

MOD 0117

V2A	304	Inox brossé		
INDOOR*				
130117-033-12	33,7	Ø	QS-10	375
				2
130117-042-12	42,4	Ø	QS-10	375
				2
130117-048-12	48,3	Ø	QS-10	375
				2
V4A				
316				
OUTDOOR				
140117-042-12	42,4	Ø	QS-11	376
				2
140117-048-12	48,3	Ø	QS-11	376
				2
V4A				
316				
Poli miroir				
OUTDOOR				
140117-042-10	42,4	Ø	QS-11	376
				2
140117-048-10	48,3	Ø	QS-11	376
				2



Q-INFO

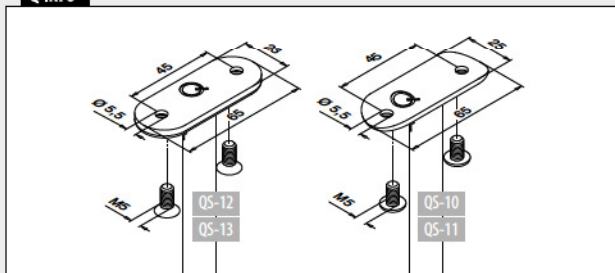

Q-INFO

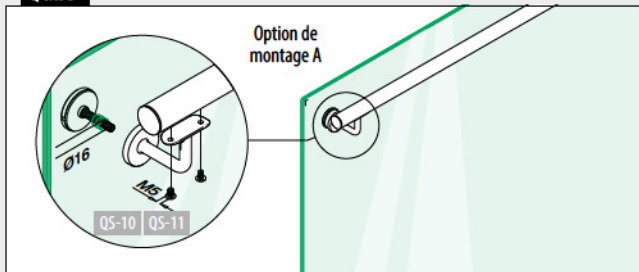

Option de montage B

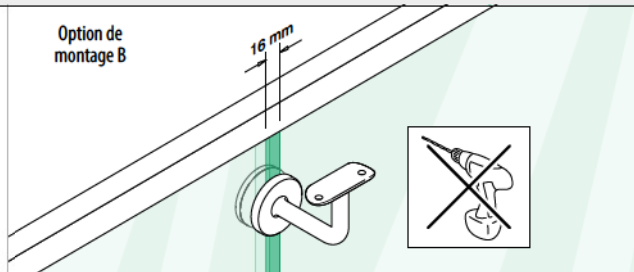

Plat - plat

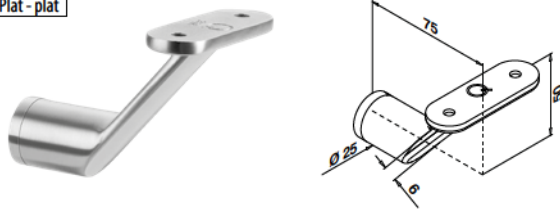

MOD 0123

V2A	304	Inox brossé		
INDOOR*				
130123-000-12		QS-12	376 / QS-21	376 2
V4A				
316 Inox brossé				
OUTDOOR				
140123-000-12		QS-13	376 / QS-22	376 2



Plat - tube

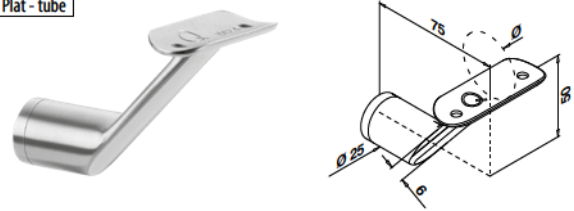

MOD 0123

V2A	304	Inox brossé		
INDOOR*				
130123-042-12	42,4	QS-10	375 / QS-21	376 2
130123-048-12	48,3	QS-10	375 / QS-21	376 2
V4A				
316 Inox brossé				
OUTDOOR				
140123-042-12	42,4	QS-11	376 / QS-22	376 2



Tube - tube

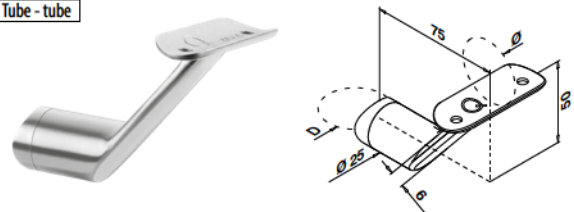

MOD 0124

V2A	304	Inox brossé		
INDOOR*				
130124-042-12	42,4	42,4	QS-10	375 / QS-21 376 2
V4A				
316 Inox brossé				
OUTDOOR				
140124-042-12	42,4	42,4	QS-11	376 / QS-22 376 2

MOD 0125

V2A	304	Inox brossé		
INDOOR*				
130125-042-12	48,3	42,4	QS-10	375 / QS-21 376 2
130125-048-12	48,3	48,3	QS-10	375 / QS-21 376 2
V4A				
316 Inox brossé				
OUTDOOR				
140125-048-12	48,3	48,3	QS-11	376 / QS-22 376 2



Q-INFO

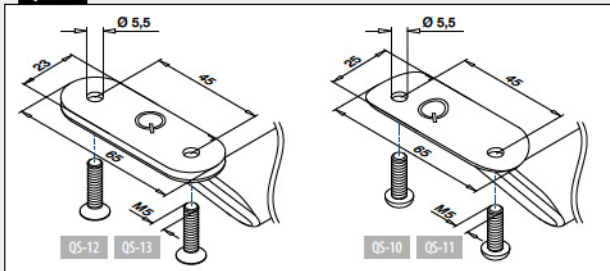

Q-INFO

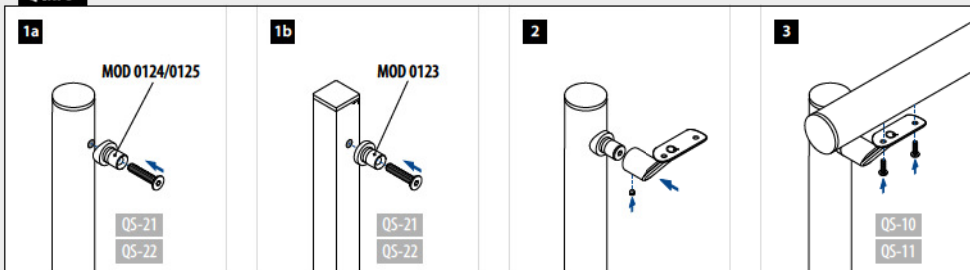

* Aussi pour l'extérieur dans des conditions physico-chimiques normales.

Q-INFO



Vidéo d'installation :
q-railing.com/
qr-supports-de-main-courante

Plat - tube

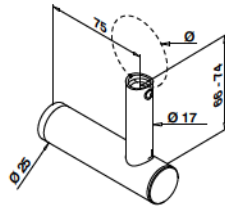

MOD 0147

V2A	304	Inox brossé		
INDOOR*				
SELL OUT	130147-044	42,4 / 48,3	QS-21	376 / QS-25
			376	2
V4A				
316				
OUTDOOR				
SELL OUT	140147-044	42,4 / 48,3	QS-22	376 / QS-71
			376	2



International Design Modèle Protection

Tube - tube

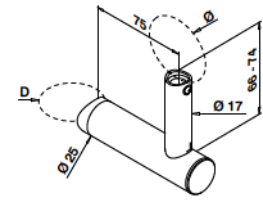

MOD 0143

V2A	304	Inox brossé	D	Ø		
INDOOR*						
SELL OUT	130143-044-12	42,4	42,4 / 48,3	QS-21	376 / QS-25	376
					376	2
V4A						
316						
OUTDOOR						
SELL OUT	140143-044-12	42,4	42,4 / 48,3	QS-22	376 / QS-71	376
					376	2

MOD 0144

V2A	304	Inox brossé	D	Ø		
INDOOR*						
SELL OUT	130144-044-12	48,3	42,4 / 48,3	QS-21	376 / QS-25	376
					376	2



International Design Modèle Protection

Tube - tube

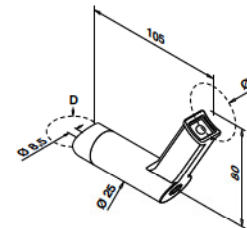

MOD 9330

V2A	304	Inox brossé	D	Ø		
INDOOR*						
SELL OUT	139330-042	42,4	42,4	QS-21	376 / QS-25	376
					376	2



SEIL OUT Seulement jusqu'à épuisement des stocks.

Q-INFO MOD 0147 / 0143 / 0144

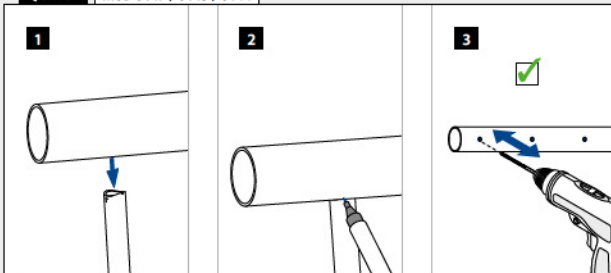

Q-INFO MOD 0143 / 0144 / 0147

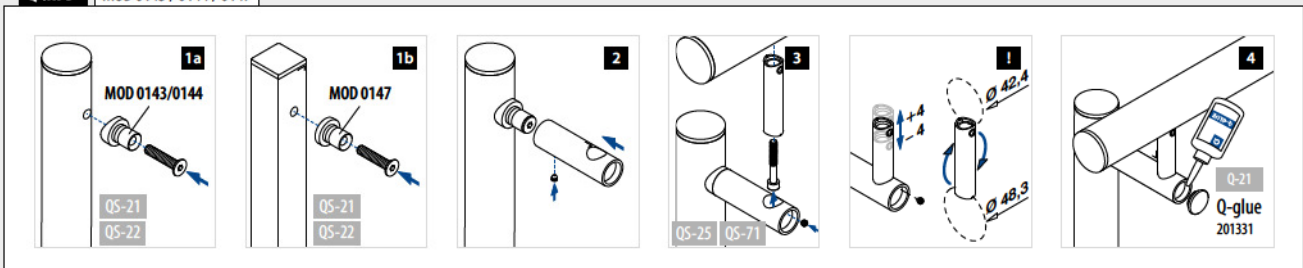

Tube - plat

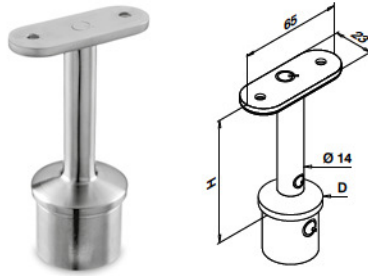

MOD 0709

V2A	304	Inox brossé					
INDOOR*		D	H				
130709-000-00-12	33,7 x 2,0	80	Ø 14	Q5-12	376	2	

MOD 0710

V2A	304	Inox brossé					
INDOOR*		D	H				
130710-000-00-12	42,4 x 2,0	81	Ø 14	Q5-12	376	2	

V4A	316	Inox brossé					
OUTDOOR		D	H				
140710-000-00-12	42,4 x 2,0	81	Ø 14	Q5-13	376	2	

MOD 0711

V2A	304	Inox brossé					
INDOOR*		D	H				
SELL OUT 130711-200-12	48,3 x 2,0	82	Ø 14	Q5-12	376	2	

MOD 0712

V2A	304	Inox brossé					
INDOOR*		D	H				
SELL OUT 130712-000-00-12	42,4 x 2,6	81	Ø 14	Q5-12	376	2	

V4A	316	Inox brossé					
OUTDOOR		D	H				
SELL OUT 140712-000-00-12	42,4 x 2,6	81	Ø 14	Q5-13	376	2	

MOD 0713

V4A	316	Inox brossé					
OUTDOOR		D	H				
140713-000-00-12	48,3 x 2,6	82	Ø 14	Q5-13	376	2	



Tube - tube

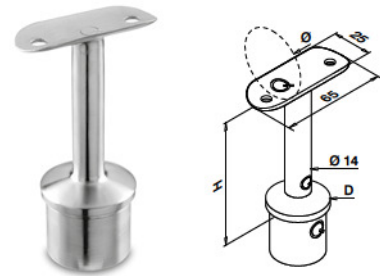

MOD 0709

V2A	304	Inox brossé					
INDOOR*		D	Ø	H			
130709-033-00-12	33,7 x 2,0	33,7	78	Ø 14	Q5-10	375	2
130709-042-00-12	33,7 x 2,0	42,4	78	Ø 14	Q5-10	375	2

MOD 0710

V2A	304	Inox brossé					
INDOOR*		D	Ø	H			
130710-042-00-12	42,4 x 2,0	42,4	79	Ø 14	Q5-10	375	2
130710-048-00-12	42,4 x 2,0	48,3	79	Ø 14	Q5-10	375	2

V2A	304	Poli miroir					
INDOOR*		D	Ø	H			
SELL OUT 130710-042-00-10	42,4 x 2,0	42,4	79	Ø 14	Q5-10	375	2

V4A	316	Inox brossé					
OUTDOOR		D	Ø	H			
140710-042-00-12	42,4 x 2,0	42,4	79	Ø 14	Q5-11	376	2

V4A	316	Poli miroir					
OUTDOOR		D	Ø	H			
140710-042-00-10	42,4 x 2,0	42,4	79	Ø 14	Q5-11	376	2

MOD 0711

V2A	304	Inox brossé					
INDOOR*		D	Ø	H			
130711-048-00-12	48,3 x 2,0	48,3	80	Ø 14	Q5-10	375	2

V4A	316	Inox brossé					
OUTDOOR		D	Ø	H			
140711-048-00-12	48,3 x 2,0	48,3	80	Ø 14	Q5-11	376	2

MOD 0712

V2A	304	Inox brossé					
INDOOR*		D	Ø	H			
SELL OUT 130712-042-00-12	42,4 x 2,6	42,4	79	Ø 14	Q5-10	375	2
SELL OUT 130712-048-00-12	42,4 x 2,6	48,3	79	Ø 14	Q5-10	375	2

V4A	316	Inox brossé					
OUTDOOR		D	Ø	H			
SELL OUT 140712-042-00-12	42,4 x 2,6	42,4	79	Ø 14	Q5-11	376	2

MOD 0713

V2A	304	Inox brossé					
INDOOR*		D	Ø	H			
130713-042-00-12	48,3 x 2,6	42,4	80	Ø 14	Q5-10	375	2
130713-048-00-12	48,3 x 2,6	48,3	80	Ø 14	Q5-10	375	2

V4A	316	Inox brossé					
OUTDOOR		D	Ø	H			
140713-042-00-12	48,3 x 2,6	42,4	80	Ø 14	Q5-11	376	2
140713-048-00-12	48,3 x 2,6	48,3	80	Ø 14	Q5-11	376	2



Q-INFO

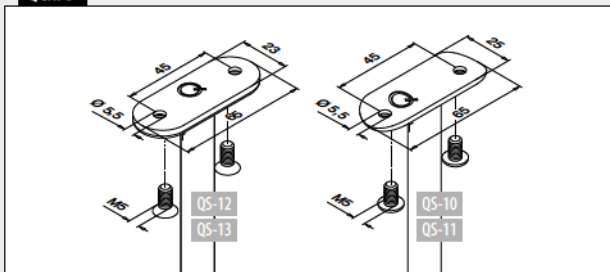

* Aussi pour l'extérieur dans des conditions physico-chimiques normales.



Seulement jusqu'à épuisement des stocks.

Tube - tube

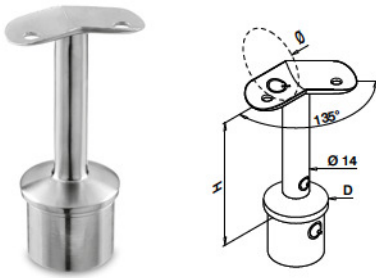

MOD 0710

V2A	304	Inox brossé				
INDOOR*		D	Ø	H	Accessories	Qty
130710-042-45-12	42,4 x 2,0	42,4	79	QS-10	375	2
V4A	316	Inox brossé				
OUTDOOR		D	Ø	H	Accessories	Qty
140710-042-45-12	42,4 x 2,0	42,4	79	QS-11	376	2

MOD 0711

V4A	316	Inox brossé				
OUTDOOR		D	Ø	H	Accessories	Qty
140711-048-45-12	48,3 x 2,0	48,3	80	QS-11	376	2

MOD 0712

V2A	304	Inox brossé				
INDOOR*		D	Ø	H	Accessories	Qty
130712-042-45-12	42,4 x 2,6	42,4	79	QS-10	375	2
V4A	316	Inox brossé				
OUTDOOR		D	Ø	H	Accessories	Qty
140712-042-45-12	42,4 x 2,6	42,4	79	QS-11	376	2

MOD 0713

V4A	316	Inox brossé				
OUTDOOR		D	Ø	H	Accessories	Qty
140713-048-45-12	48,3 x 2,6	48,3	80	QS-11	376	2



Tube - tube

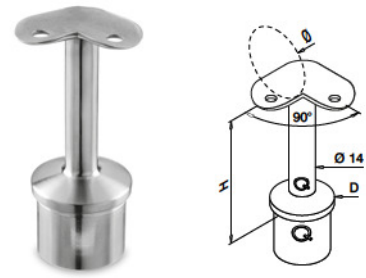

MOD 0709

V2A	304	Inox brossé				
INDOOR*		D	Ø	H	Accessories	Qty
130709-033-90-12	33,7 x 2,0	33,7	78	QS-10	375	2
130709-042-90-12	33,7 x 2,0	42,4	78	QS-10	375	2
V4A	316	Inox brossé				
OUTDOOR		D	Ø	H	Accessories	Qty
140710-042-90-12	42,4 x 2,0	42,4	79	QS-11	376	2

MOD 0710

V2A	304	Inox brossé				
INDOOR*		D	Ø	H	Accessories	Qty
130710-042-90-12	42,4 x 2,0	42,4	79	QS-10	375	2
130710-048-90-12	42,4 x 2,0	48,3	79	QS-10	375	2
V4A	316	Inox brossé				
OUTDOOR		D	Ø	H	Accessories	Qty
140710-042-90-12	42,4 x 2,0	42,4	79	QS-11	376	2

V4A	316	Poli miroir				
OUTDOOR		D	Ø	H	Accessories	Qty
140710-042-90-10	42,4 x 2,0	42,4	79	QS-11	376	2

MOD 0711

V2A	304	Inox brossé				
INDOOR*		D	Ø	H	Accessories	Qty
130711-048-90-12	48,3 x 2,0	48,3	80	QS-10	375	2
V4A	316	Inox brossé				
OUTDOOR		D	Ø	H	Accessories	Qty
140711-048-90-12	48,3 x 2,0	48,3	80	QS-11	376	2

MOD 0712

V2A	304	Inox brossé				
INDOOR*		D	Ø	H	Accessories	Qty
130712-042-90-12	42,4 x 2,6	42,4	79	QS-10	375	2
V4A	316	Inox brossé				
OUTDOOR		D	Ø	H	Accessories	Qty
140712-042-90-12	42,4 x 2,6	42,4	79	QS-11	376	2

MOD 0713

V2A	304	Inox brossé				
INDOOR*		D	Ø	H	Accessories	Qty
130713-042-90-12	48,3 x 2,6	42,4	80	QS-10	375	2
130713-048-90-12	48,3 x 2,6	48,3	80	QS-10	375	2
V4A	316	Inox brossé				
OUTDOOR		D	Ø	H	Accessories	Qty
140713-048-90-12	48,3 x 2,6	48,3	80	QS-11	376	2



Q-INFO MOD 071x-04x-45

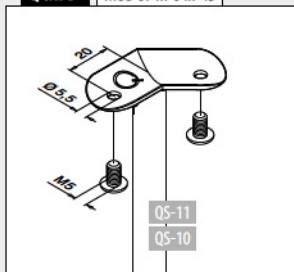

Q-INFO MOD 071x-04x-45

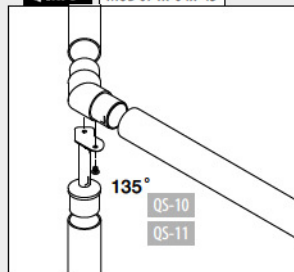

Q-INFO MOD 071x-04x-90

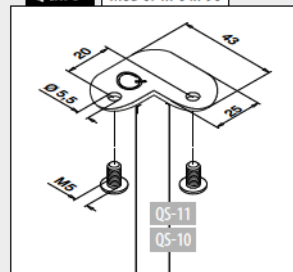

Q-INFO MOD 071x-04x-90

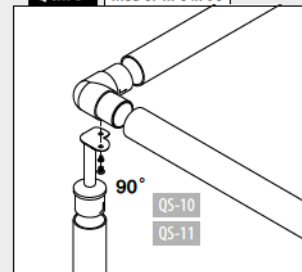

Tube - plat

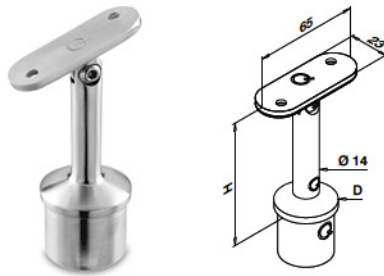

MOD 0717

V2A	304	Inox brossé				
INDOOR*		D	H			
SELL OUT	130717-000-12	33,7 x 2,0	80	QS-12	376	2

MOD 0718

V2A	304	Inox brossé				
INDOOR*		D	H			
	130718-000-12	42,4 x 2,0	81	QS-12	376	2

MOD 0720

V2A	304	Inox brossé				
INDOOR*		D	H			
SELL OUT	130720-000-12	42,4 x 2,6	81	QS-12	376	2



Tube - tube

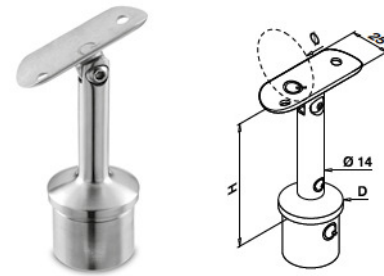

MOD 0717

V2A	304	Inox brossé					
INDOOR*		D	Ø	H			
	130717-033-12	33,7 x 2,0	33,7	78	QS-10	375	2
	130717-042-12	33,7 x 2,0	42,4	78	QS-10	375	2

MOD 0718

V2A	304	Inox brossé					
INDOOR*		D	Ø	H			
	130718-042-12	42,4 x 2,0	42,4	79	QS-10	375	2
	130718-048-12	42,4 x 2,0	48,3	79	QS-10	375	2

V2A	304	Poli miroir					
INDOOR*		D	Ø	H			
SELL OUT	130718-042-10	42,4 x 2,0	42,4	79	QS-10	375	2

V4A	316	Inox brossé					
OUTDOOR		D	Ø	H			
	140718-042-12	42,4 x 2,0	42,4	79	QS-11	376	2
	140718-048-12	42,4 x 2,0	48,3	79	QS-11	376	2

V4A	316	Poli miroir					
OUTDOOR		D	Ø	H			
	140718-042-10	42,4 x 2,0	42,4	79	QS-11	376	2

MOD 0719

V2A	304	Inox brossé					
INDOOR*		D	Ø	H			
	130719-048-12	48,3 x 2,0	48,3	80	QS-10	375	2

V4A	316	Inox brossé					
OUTDOOR		D	Ø	H			
	140719-048-12	48,3 x 2,0	48,3	80	QS-11	376	2

MOD 0720

V2A	304	Inox brossé					
INDOOR*		D	Ø	H			
SELL OUT	130720-042-12	42,4 x 2,6	42,4	79	QS-10	375	2
SELL OUT	130720-048-12	42,4 x 2,6	48,3	79	QS-10	375	2

V4A	316	Inox brossé					
OUTDOOR		D	Ø	H			
SELL OUT	140720-042-12	42,4 x 2,6	42,4	79	QS-11	376	2

MOD 0721

V2A	304	Inox brossé					
INDOOR*		D	Ø	H			
	130721-042-12	48,3 x 2,6	42,4	80	QS-10	375	2
	130721-048-12	48,3 x 2,6	48,3	80	QS-10	375	2

V4A	316	Inox brossé					
OUTDOOR		D	Ø	H			
	140721-042-12	48,3 x 2,6	42,4	80	QS-11	376	2
	140721-048-12	48,3 x 2,6	48,3	80	QS-11	376	2



Q-INFO

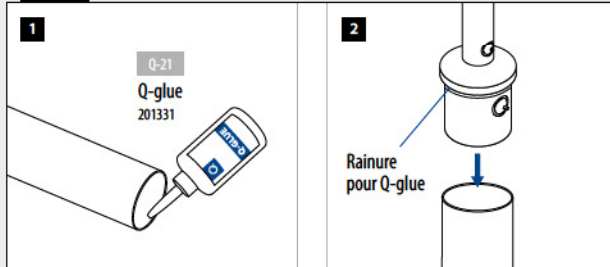

Q-INFO

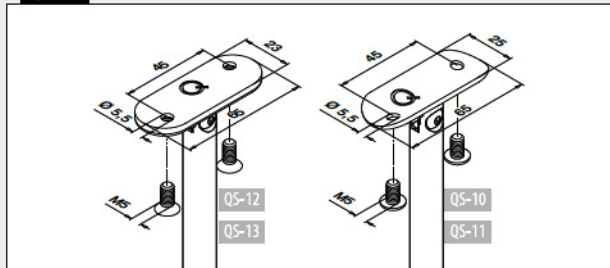

* Aussi pour l'extérieur dans des conditions physico-chimiques normales.

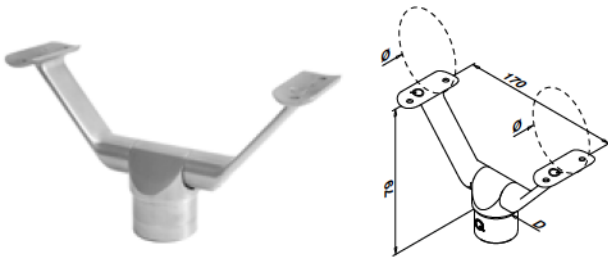

Seulement jusqu'à épuisement des stocks.

**MOD 0693**

V4A	316	Inox brossé			
	OUTDOOR	D	Ø		
140693-042-12	42,4 x 2,0	42,4	05-11	376	2

MOD 0694

V4A	316	Inox brossé			
	OUTDOOR	D	Ø		
140694-048-12	48,3 x 2,0	48,3	05-11	376	2

NEW

International Design Modèle Protection

Cintres

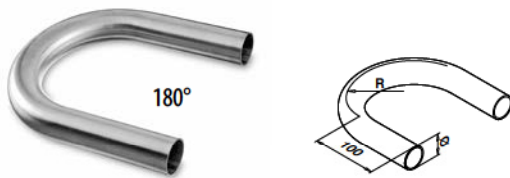
**MOD 0906**

V2A	304	Inox brossé			
	INDOOR*	Ø	R		
130906-242-12	42,4 x 2,0	85		1	
130906-248-12	48,3 x 2,0	97		1	

V4A	316	Inox brossé			
	OUTDOOR	Ø	R		
140906-242-12	42,4 x 2,0	85		1	
NEW 140906-248-12	48,3 x 2,0	97		1	

* Aussi pour l'extérieur dans des conditions physico-chimiques normales.

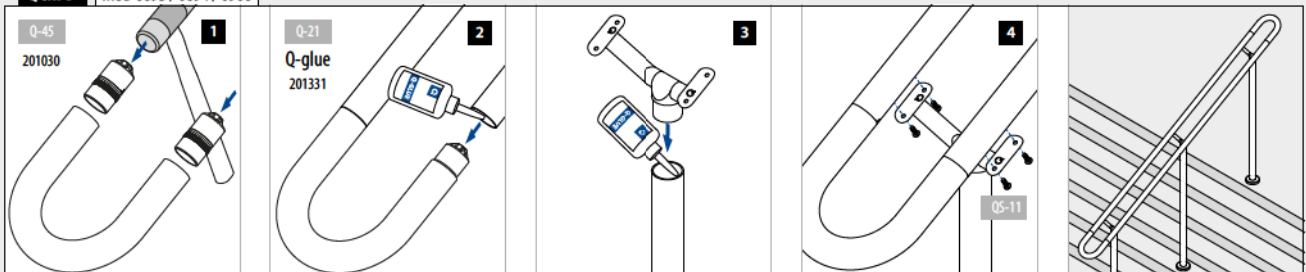
Q-INFO MOD 0693 / 0694 / 0906

Tube - tube

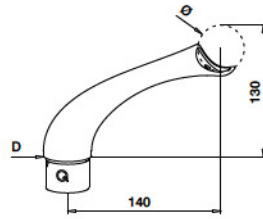

MOD 0706

V2A	304	Inox brossé				
	INDOOR*	D	Ø			
130706	42,4 x 2,0	42,4	Q5-83	376	2	

V4A	316	Inox brossé				
	OUTDOOR	D	Ø			
140706	42,4 x 2,0	42,4	Q5-84	376	2	



International Design Modèle Protection

Tube - tube

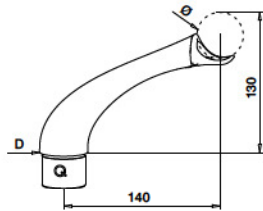
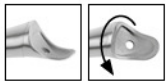
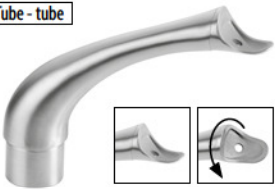

MOD 0704

V4A	316	Inox brossé				
	OUTDOOR	D	Ø			
140704	42,4 x 2,0	42,4	Q5-84	376	2	



International Design Modèle Protection

Q-INFO

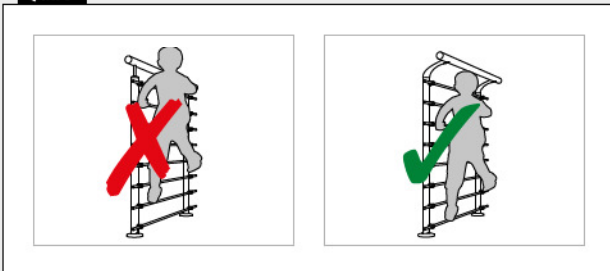

Q-INFO MOD 0706

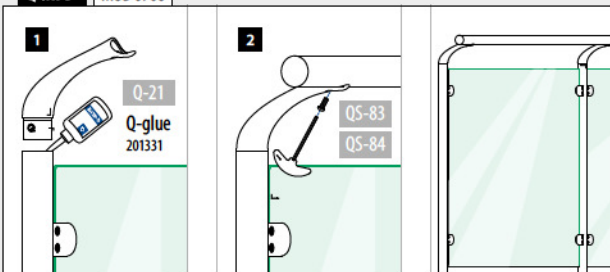

Q-INFO MOD 0704

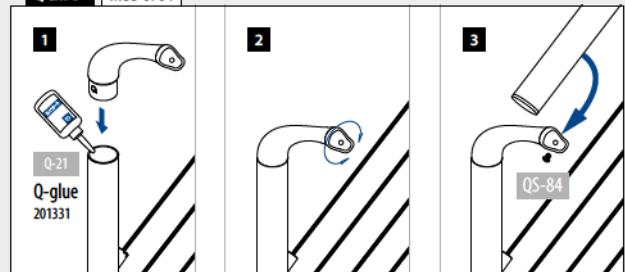

Tube - tube

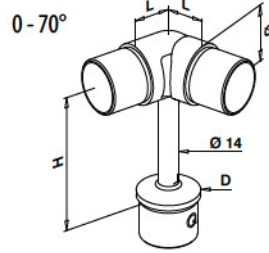

MOD 0736

V2A	304	Inox brossé				
INDOOR*		D	Ø	H	L	
130736-242		42,4 x 2,0	42,4 x 2,0	100	27	2
V4A	316	Inox brossé				
OUTDOOR		D	Ø	H	L	
140736-242		42,4 x 2,0	42,4 x 2,0	100	27	2



Tube - plat

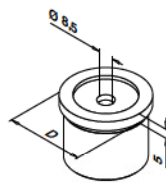

MOD 0730

V2A	304	Inox brossé			
INDOOR*		D			
130730-000		33,7 x 2,0	Q5-26	376	2

MOD 0725

V2A	304	Inox brossé			
INDOOR*		D			
130725-000		42,4 x 2,0	Q5-26	376	2

V4A	316	Inox brossé			
OUTDOOR		D			
140725-000		42,4 x 2,0	Q5-27	376	2

MOD 0727

V2A	304	Inox brossé			
INDOOR*		D			
SELL OUT 130727-000		42,4 x 2,6	Q5-26	376	2

V4A	316	Inox brossé			
OUTDOOR		D			
SELL OUT 140727-000		42,4 x 2,6	Q5-27	376	2

MOD 0726

V2A	304	Inox brossé			
INDOOR*		D			
130726-000		48,3 x 2,0	Q5-26	376	2

MOD 0728

V2A	304	Inox brossé			
INDOOR*		D			
SELL OUT 130728-000		48,3 x 2,6	Q5-26	376	2



Tube - tube



0-70°

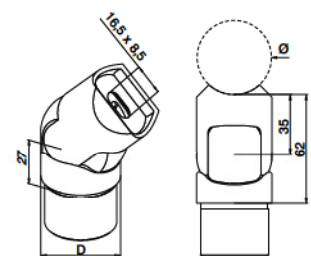

MOD 0776

V2A	304	Inox brossé				
INDOOR*		D	Ø			
130776-042-12		42,4 x 2,0	42,4	Q5-26	376	2

V4A	316	Inox brossé				
OUTDOOR		D	Ø			
140776-042-12		42,4 x 2,0	42,4	Q5-27	376	2

MOD 0777

V2A	304	Inox brossé				
INDOOR*		D	Ø			
130777-048-12		48,3 x 2,0	48,3	Q5-26	376	2

V4A	316	Inox brossé				
OUTDOOR		D	Ø			
140777-048-12		48,3 x 2,0	48,3	Q5-27	376	2



International Design Modèle Protection

Q-INFO MOD 0776 / 0777

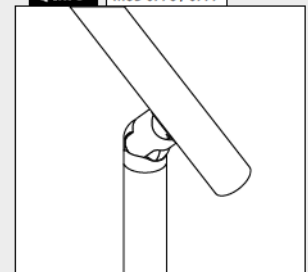

Tube - tube

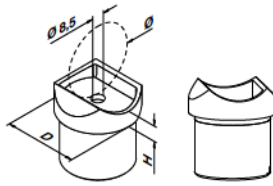
**MOD 0774**

V2A	304	Inox brossé					
INDOOR*			D	Ø	H		
130774-12	33,7 x 2,0	33,7	8	Q5-26	376	2	

Compatible avec MOD 0303 raccords

Tube - tube

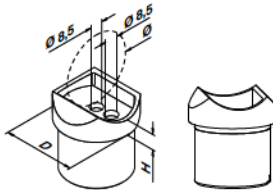
**MOD 0770**

V2A	304	Inox brossé					
INDOOR*			D	Ø	H		
130770-042-12	42,4 x 2,0	42,4	9	Q5-26	376	2	

V4A	316	Inox brossé					
OUTDOOR			D	Ø	H		
140770-042-12	42,4 x 2,0	42,4	9	Q5-27	376	2	

V4A	316	Poli miroir					
OUTDOOR			D	Ø	H		
140770-042-10	42,4 x 2,0	42,4	9	Q5-27	376	2	

MOD 0772

V2A	304	Inox brossé					
INDOOR*			D	Ø	H		
SELL OUT 130772-042-12	42,4 x 2,6	42,4	9	Q5-26	376	2	

V4A	316	Inox brossé					
OUTDOOR			D	Ø	H		
SELL OUT 140772-042-12	42,4 x 2,6	42,4	9	Q5-27	376	2	

MOD 0771

V2A	304	Inox brossé					
INDOOR*			D	Ø	H		
130771-048-12	48,3 x 2,0	48,3	11	Q5-26	376	2	

V4A	316	Inox brossé					
OUTDOOR			D	Ø	H		
140771-048-12	48,3 x 2,0	48,3	11	Q5-27	376	2	

MOD 0773

V2A	304	Inox brossé					
INDOOR*			D	Ø	H		
130773-048-12	48,3 x 2,6	48,3	11	Q5-26	376	2	

V4A	316	Inox brossé					
OUTDOOR			D	Ø	H		
140773-048-12	48,3 x 2,6	48,3	11	Q5-27	376	2	



Compatible avec MOD 0303 raccords

* Aussi pour l'extérieur dans des conditions physico-chimiques normales.



Seulement jusqu'à épuisement des stocks.

Tube - tube

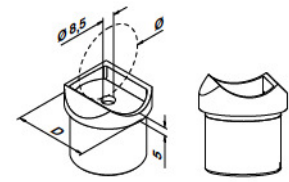
**MOD 0730**

V2A	304	Inox brossé					
INDOOR*			D	Ø	H		
130730-042	33,7 x 2,0	42,4		Q5-26	376	2	

MOD 0725

V2A	304	Inox brossé					
INDOOR*			D	Ø	H		
130725-048	42,4 x 2,0	48,3		Q5-26	376	2	

V4A	316	Inox brossé					
OUTDOOR			D	Ø	H		
140725-048	42,4 x 2,0	48,3		Q5-27	376	2	

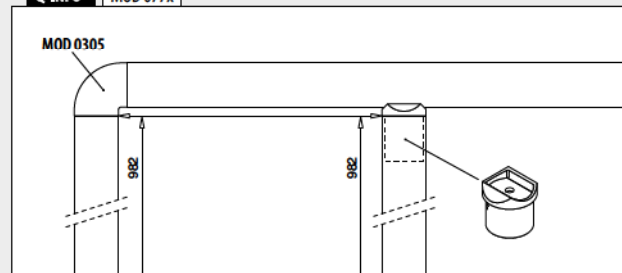
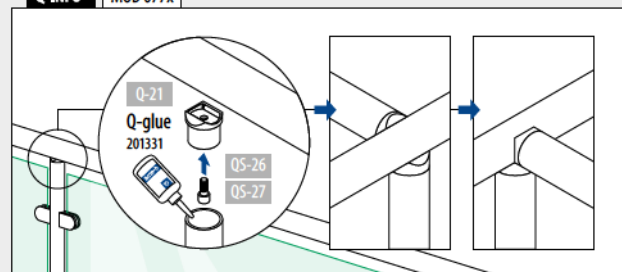

Incompatible avec MOD 0303 raccords

Q-INFO MOD 077x**Q-INFO** MOD 077x

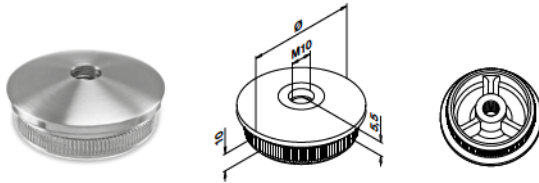
**MOD 5735 - EASY HIT®**

V2A	304	Inox brossé		
	INDOOR*		Ø	
	135735-242		42,4 x 2,0	2
	135735-042		42,4 x 2,6	2
	135735-248		48,3 x 2,0	2
	135735-048		48,3 x 2,6	2
V4A	316	Inox brossé		
	OUTDOOR		Ø	
	145735-242		42,4 x 2,0	2
	145735-042		42,4 x 2,6	2
	145735-248		48,3 x 2,0	2
	145735-048		48,3 x 2,6	2
	145735-060		60,3 x 2,0	2



MOD 4811
213

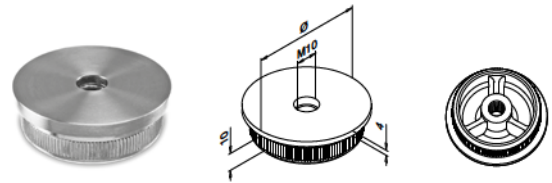

MOD 4733
213

**MOD 5736 - EASY HIT®**

V2A	304	Inox brossé		
	INDOOR*		Ø	
	135736-242		42,4 x 2,0	2
	135736-042		42,4 x 2,6	2
	135736-248		48,3 x 2,0	2
	135736-048		48,3 x 2,6	2
V4A	316	Inox brossé		
	OUTDOOR		Ø	
	145736-242		42,4 x 2,0	2
	145736-248		48,3 x 2,0	2



* Aussi pour l'extérieur dans des conditions physico-chimiques normales.

Tube - plat

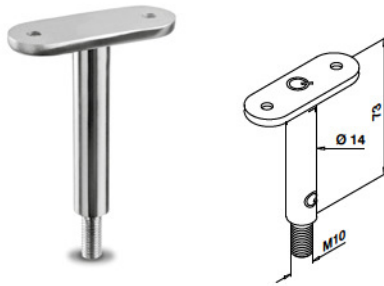

MOD 0810

V2A	304	Inox brossé		
INDOOR*				
SELL OUT	130810-000-00	QS-12	376	2



Tube - tube

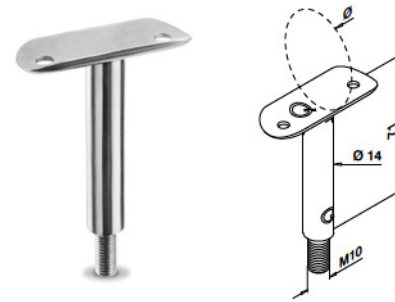

MOD 0810

V2A	304	Inox brossé		
INDOOR*				
		Ø		
	130810-042-00	42,4	QS-10	375 2
	130810-048-00	48,3	QS-10	375 2

V4A	316	Inox brossé		
OUTDOOR				
		Ø		
	140810-042-00	42,4	QS-11	376 2
	140810-048-00	48,3	QS-11	376 2



Tube - tube

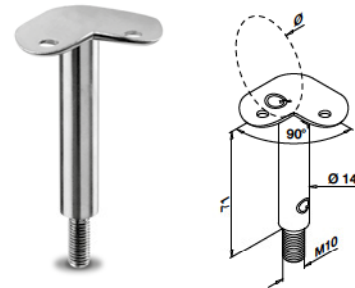

MOD 0810

V2A	304	Inox brossé		
INDOOR*				
		Ø		
	130810-042-90	42,4	QS-10	375 2
	130810-048-90	48,3	QS-10	375 2

V4A	316	Inox brossé		
OUTDOOR				
		Ø		
	140810-042-90	42,4	QS-11	376 2
	140810-048-90	48,3	QS-11	376 2



Q-INFO MOD 0810-000 / 0810-04x-00

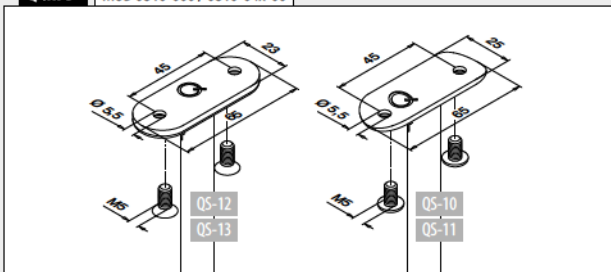

Q-INFO MOD 0810-04x-90

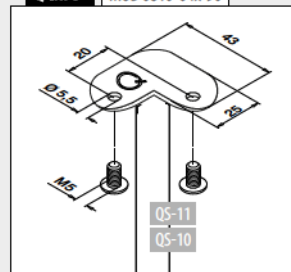

Tube - plat

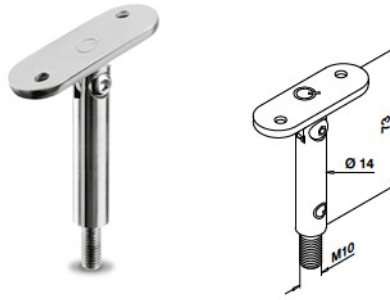

MOD 0818

V2A	304	Inox brossé		
INDOOR*				
130818-000		QS-12	376	2



Tube - tube

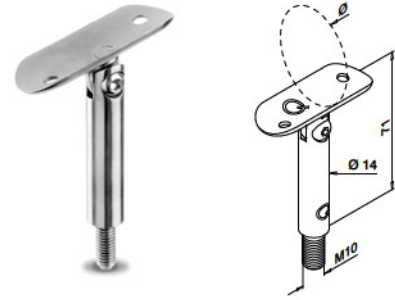

MOD 0818

V2A	304	Inox brossé		
INDOOR*				
130818-042	42,4	QS-10	375	2
130818-048	48,3	QS-10	375	2

V4A	316	Inox brossé		
OUTDOOR				
140818-042	42,4	QS-11	376	2
140818-048	48,3	QS-11	376	2



Tiges pour support de main-courante

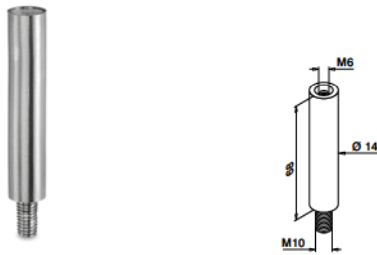

MOD 0811

V2A	304	Inox brossé		
INDOOR*				
130811		QS-48	376	2

V4A	316	Inox brossé		
OUTDOOR				
140811		QS-89	376	2



MOD 4811

213



MOD 4733

213

Tiges pour support de main-courante



MOD 0812

V2A	304	Inox brossé		
INDOOR*				
130812		QS-48	376	2

V4A	316	Inox brossé		
OUTDOOR				
140812		QS-89	376	2



Q-INFO MOD 0818

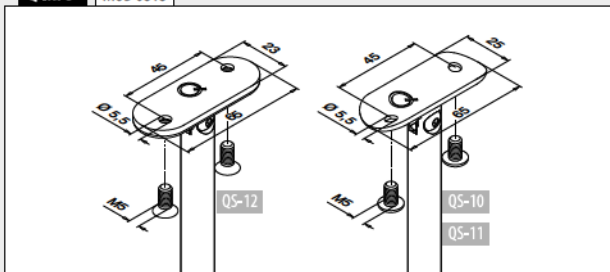

Q-INFO MOD 0811 / 0812

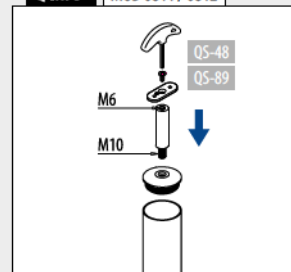

Berceaux pour tube



MOD 1810

V2A	304	Inox brossé			
INDOOR*					
131810-000-12	Ø5-48	Ø376 / Ø5-10	Ø375	8	
V4A	316	Inox brossé			
OUTDOOR					
141810-000-12	Ø5-89	Ø376 / Ø5-11	Ø376	8	

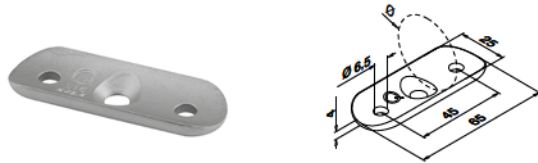

MOD 1810

V2A	304	Inox brossé			
INDOOR*					
131810-033-12	33,7	Ø5-48	Ø376 / Ø5-10	Ø375	8
131810-042-12	42,4	Ø5-48	Ø376 / Ø5-10	Ø375	8
131810-048-12	48,3	Ø5-48	Ø376 / Ø5-10	Ø375	8
V4A	316	Inox brossé			
OUTDOOR					
141810-042-12	42,4	Ø5-89	Ø376 / Ø5-11	Ø376	8
141810-048-12	48,3	Ø5-89	Ø376 / Ø5-11	Ø376	8



Berceaux pour tube

Orientables



MOD 3302

V4A	316	Inox brossé			
OUTDOOR					
143302-000-12	Ø5-12	Ø376		2	

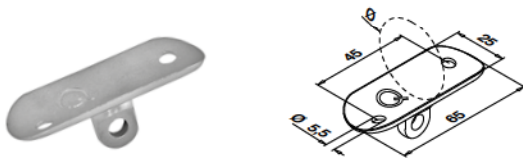

MOD 3302

V4A	316	Inox brossé			
OUTDOOR					
143302-042-12	42,4	Ø5-11	Ø376		2
143302-048-12	48,3	Ø5-11	Ø376		2

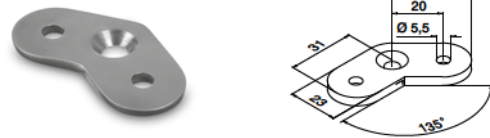

MOD 1801

V2A	304	Inox brossé			
INDOOR*					
131801-000	Ø5-48	Ø376		8	

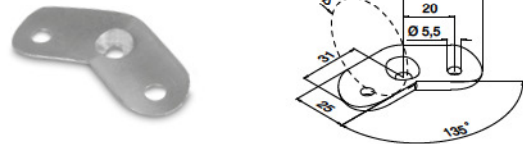

MOD 1801

V2A	304	Inox brossé			
INDOOR*					
131801-042	42,4	Ø5-48	Ø376 / Ø5-10	Ø375	8
SELL OUT 131801-048	48,3	Ø5-48	Ø376 / Ø5-10	Ø375	8

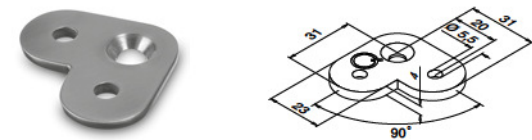

MOD 1802

V2A	304	Inox brossé			
INDOOR*					
131802-000	Ø5-48	Ø376 / Ø5-10	Ø375	8	

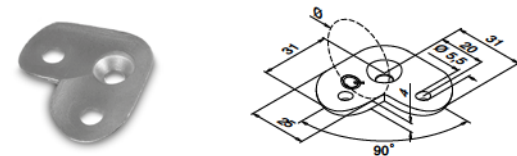

MOD 1802

V2A	304	Inox brossé			
INDOOR*					
131802-042	42,4	Ø5-48	Ø376 / Ø5-10	Ø375	8
131802-048	48,3	Ø5-48	Ø376 / Ø5-10	Ø375	8

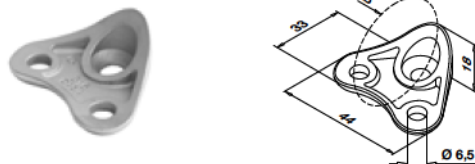

MOD 1820

V4A	316	Inox brossé			
OUTDOOR					
141820-042-12	42,4	Ø5-89	Ø376 / Ø5-11	Ø376	8

Compatible avec MOD 0305 raccords
International Design Modèle Protection

* Aussi pour l'extérieur dans des conditions physico-chimiques normales.



Seulement jusqu'à épuisement des stocks.



Q-TUBE

TUBES INOX DE Q-RAILING

TOLÉRANCES STRICTES ET FINITION IRRÉPROCHABLE.

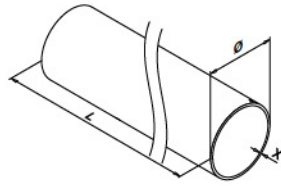
**MOD 0900**

Ø 33,7 mm

V2A	304	Inox brossé		
	INDOOR*	X		
	130900-233-50-12	2,0		L = 5000 mm
V4A	316	Inox brossé		
	OUTDOOR	X		
	140900-233-50-12	2,0		L = 5000 mm

Ø 42,4 mm

V2A	304	Inox brossé		
	INDOOR*	X		
	130900-142-50-12	1,5		L = 5000 mm
	130900-242-25-12	2,0		L = 2500 mm
	130900-242-50-12	2,0		L = 5000 mm
	130900-042-50-12	2,6		L = 5000 mm
V2A	304	Poli miroir		
	INDOOR*	X		
	130900-242-50-10	2,0		L = 5000 mm
V4A	316	Inox brossé		
	OUTDOOR	X		
	140900-142-50-12	1,5		L = 5000 mm
	140900-242-25-12	2,0		L = 2500 mm
	140900-242-50-12	2,0		L = 5000 mm
	140900-042-50-12	2,6		L = 5000 mm
V4A	316	Poli miroir		
	OUTDOOR	X		
	140900-242-50-10	2,0		L = 5000 mm

Ø 48,3 mm

V2A	304	Inox brossé		
	INDOOR*	X		
	130900-248-25-12	2,0		L = 2500 mm
	130900-248-50-12	2,0		L = 5000 mm
	130900-048-50-12	2,6		L = 5000 mm
V4A	316	Inox brossé		
	OUTDOOR	X		
	140900-248-25-12	2,0		L = 2500 mm
	140900-248-50-12	2,0		L = 5000 mm
	140900-048-25-12	2,6		L = 2500 mm
	140900-048-50-12	2,6		L = 5000 mm

Ø 60,3 mm

V2A	304	Inox brossé		
	INDOOR*	X		
	130900-060-50-12	2,0		L = 5000 mm



Q-INFO MOD 0900

Base de calcul pour les tubes, barres et tubes à fond de gorge :
q-railing.com/test-calculs

Q-INFO MOD 0900

PREFIX

Q-INFO

Gain de temps et d'argent avec Q-tube

Le degré de tolérance réduit ainsi que le cordon racle de la soudure de nos tubes permettent un parfait emboîtement et garantissent ainsi efficacité et rapidité d'installation. Dans un souci de qualité tous nos tubes sont conditionnés et emballés séparément.

* Aussi pour l'extérieur dans des conditions physico-chimiques normales.

Seulement jusqu'à épuisement des stocks.

Raccords



MOD 5792 - EASY HIT®

V2A	304	Brut		
INDOOR*				
SELL OUT	135792-242	pour 42,4 x 2,0	2	
SELL OUT	135792-042	pour 42,4 x 2,6	2	
	135792-248	pour 48,3 x 2,0	2	
SELL OUT	135792-048	pour 48,3 x 2,6	2	
SELL OUT	135792-060	pour 60,3 x 2,0	2	
V4A	316	Brut		
OUTDOOR				
SELL OUT	145792-233	pour 33,7 x 2,0	2	
	145792-242	pour 42,4 x 2,0	2	
SELL OUT	145792-042	pour 42,4 x 2,6	2	
	145792-248	pour 48,3 x 2,0	2	
SELL OUT	145792-048	pour 48,3 x 2,6	2	



International Design Modèle Protection



MOD 0790

V2A	304	Inox brossé		
INDOOR*				
	130790-233-12	33,7 x 2,0	2	
SELL OUT	130790-142-12	42,4 x 1,5	2	
	130790-242-12	42,4 x 2,0	2	
SELL OUT	130790-042-12	42,4 x 2,6	2	
	130790-248-12	48,3 x 2,0	2	
	130790-048-12	48,3 x 2,6	2	
V4A	316	Inox brossé		
OUTDOOR				
	140790-242-12	42,4 x 2,0	2	
SELL OUT	140790-042-12	42,4 x 2,6	2	
	140790-248-12	48,3 x 2,0	2	



Cintres



MOD 0903

V2A	304	Inox brossé		
INDOOR*				
	130903-242-12	42,4 x 2,0	85	1
	130903-248-12	48,3 x 2,0	97	1

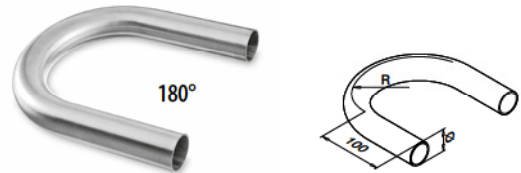

MOD 0906

V2A	304	Inox brossé		
INDOOR*				
	130906-242-12	42,4 x 2,0	85	1
	130906-248-12	48,3 x 2,0	97	1
V4A	316	Inox brossé		
OUTDOOR				
	140906-242-12	42,4 x 2,0	85	1
NEW	140906-248-12	48,3 x 2,0	97	1

Q-INFO MOD 5792

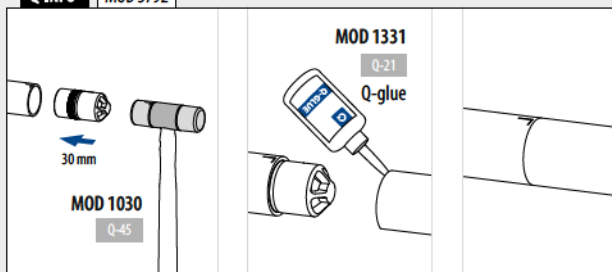

* Aussi pour l'extérieur dans des conditions physico-chimiques normales.



Seulement jusqu'à épuisement des stocks.

Raccords

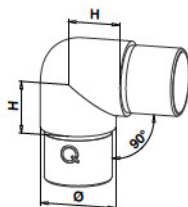

MOD 0303

V2A	304	Inox brossé			
INDOOR*		Ø	H		
	130303-233-12	33,7 x 2,0	25		2
SELL OUT	130303-142-12	42,4 x 1,5	30		2
	130303-242-12	42,4 x 2,0	30		2
SELL OUT	130303-042-12	42,4 x 2,6	30		2
	130303-248-12	48,3 x 2,0	35		2
	130303-048-12	48,3 x 2,6	35		2
SELL OUT	130303-060-12	60,3 x 2,0	40		2

V2A	304	Poli miroir			
INDOOR*		Ø	H		
SELL OUT	130303-242-10	42,4 x 2,0	30		2

V4A	316	Inox brossé			
OUTDOOR		Ø	H		
	140303-242-12	42,4 x 2,0	30		2
SELL OUT	140303-042-12	42,4 x 2,6	30		2
	140303-248-12	48,3 x 2,0	35		2
	140303-048-12	48,3 x 2,6	35		2

V4A	316	Poli miroir			
OUTDOOR		Ø	H		
	140303-242-10	42,4 x 2,0	30		2



Compatible avec 90° MOD 0710, 0810 et 4710 supports de main-courante

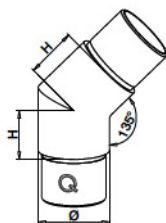

MOD 0300

V2A	304	Inox brossé			
INDOOR*		Ø	H		
	130300-242-12	42,4 x 2,0	30		2
SELL OUT	130300-042-12	42,4 x 2,6	30		2
SELL OUT	130300-248-12	48,3 x 2,0	35		2

V4A	316	Inox brossé			
OUTDOOR		Ø	H		
	140300-242-12	42,4 x 2,0	30		2
	140300-248-12	48,3 x 2,0	35		2

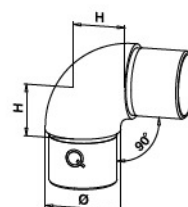

MOD 0305

V2A	304	Inox brossé			
INDOOR*		Ø	H		
	130305-233-12	33,7 x 2,0	25		2
	130305-242-12	42,4 x 2,0	30		2
	130305-248-12	48,3 x 2,0	35		2

V4A	316	Inox brossé			
OUTDOOR		Ø	H		
SELL OUT	140305-042-12	42,4 x 2,6	30		2
	140305-242-12	42,4 x 2,0	30		2
	140305-048-12	48,3 x 2,6	35		2
	140305-248-12	48,3 x 2,0	35		2

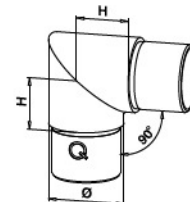
Compatible avec MOD 1820 berceaux pour tube
Incompatible avec MOD 0710, 0810 et 4710 supports de main-courante

MOD 0301

V2A	304	Inox brossé			
INDOOR*		Ø	H		
SELL OUT	130301-233-12	33,7 x 2,0	25		2
SELL OUT	130301-242-12	42,4 x 2,0	30		2

V4A	316	Inox brossé			
OUTDOOR		Ø	H		
SELL OUT	140301-242-12	42,4 x 2,0	30		2
SELL OUT	140301-248-12	48,3 x 2,0	35		2



Incompatible avec 90° MOD 0710, 0810 et 4710 supports de main-courante

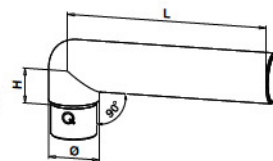

MOD 0306

V2A	304	Inox brossé			
INDOOR*		Ø	H	L	
	130306-233	33,7 x 2,0	25	223	2
	130306-242	42,4 x 2,0	30	228	2



Q-INFO MOD 0306

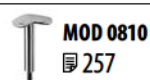
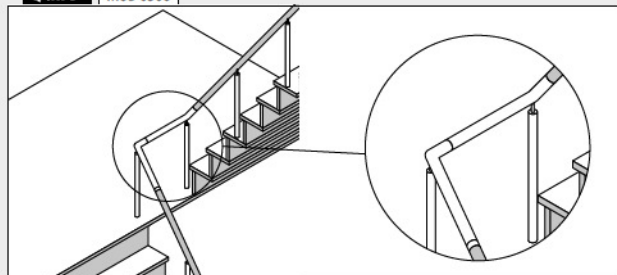

Raccords

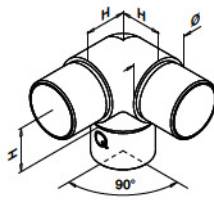

MOD 0304

V2A	304	Inox brossé			
INDOOR*			Ø	H	
	130304-233-12	33,7 x 2,0	25	2	
	130304-242-12	42,4 x 2,0	30	2	
	130304-248-12	48,3 x 2,0	35	2	
V4A	316	Inox brossé			
OUTDOOR			Ø	H	
	140304-242-12	42,4 x 2,0	30	2	
	140304-042-12	42,4 x 2,6	30	2	
	140304-248-12	48,3 x 2,0	35	2	
	140304-048-12	48,3 x 2,6	35	2	

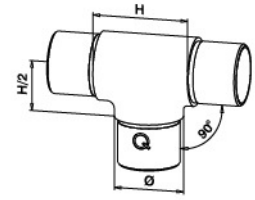

MOD 0307

V2A	304	Inox brossé				
INDOOR*			Ø	H	H/2	
	130307-233-12	33,7 x 2,0	50	25	2	
	130307-242-12	42,4 x 2,0	60	30	2	
	130307-248-12	48,3 x 2,0	70	35	2	
V4A	316	Inox brossé				
OUTDOOR			Ø	H	H/2	
	140307-242-12	42,4 x 2,0	60	30	2	
	140307-248-12	48,3 x 2,0	70	35	2	
	140307-048-12	48,3 x 2,6	70	35	2	

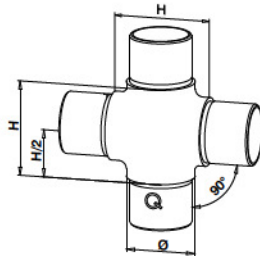

MOD 0309

V2A	304	Inox brossé				
INDOOR*			Ø	H	H/2	
	130309-242-12	42,4 x 2,0	60	30	2	



Q-INFO

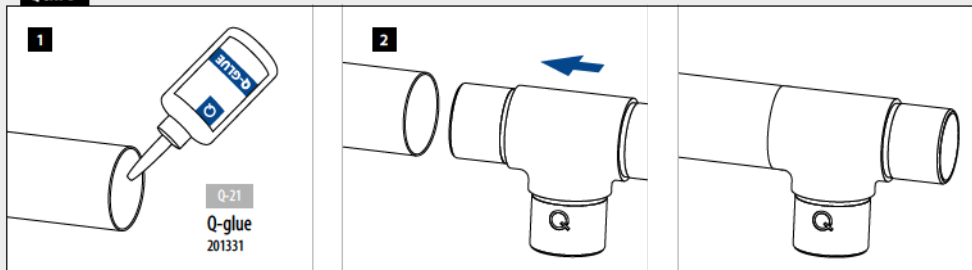

* Aussi pour l'extérieur dans des conditions physico-chimiques normales.

Seulement jusqu'à épuisement des stocks.

Haut : départ à droite
Bas : départ m-c rampant



0 - 70°

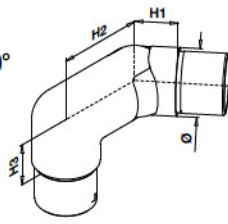

MOD 0317

V2A	304	Inox brossé				
INDOOR*		Ø	H1	H2	H3	
130317-242-01	42,4 x 2,0	27	60	30	2	
130317-248-01	48,3 x 2,0	30	65	35	2	



Haut : départ à gauche
Bas : départ m-c rampant



0 - 70°

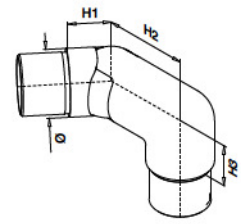

MOD 0317

V2A	304	Inox brossé				
INDOOR*		Ø	H1	H2	H3	
130317-242-02	42,4 x 2,0	27	60	30	2	
130317-248-02	48,3 x 2,0	30	65	35	2	



0 - 90°

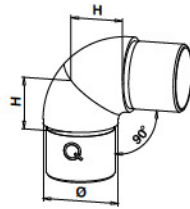

MOD 0791

V2A	304	Inox brossé		
INDOOR*		Ø	H	
130791-242-12	42,4 x 2,0	30	2	
130791-248-12	48,3 x 2,0	35	2	

V4A	316	Inox brossé		
OUTDOOR		Ø	H	
140791-242-12	42,4 x 2,0	30	2	



0° - 135°

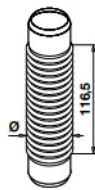

MOD 0315

V2A	304	Inox brossé		
INDOOR*		Ø		
SELL OUT 130315	42,4 x 2,0	2		



0° - 210°

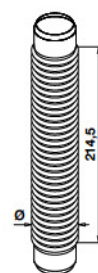

MOD 0316

V2A	304	Inox brossé		
INDOOR*		Ø		
SELL OUT 130316	42,4 x 2,0	2		



Q-INFO MOD 0317-24x-01

Q-INFO MOD 0317-24x-02

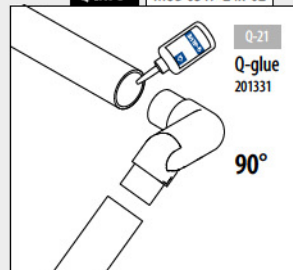
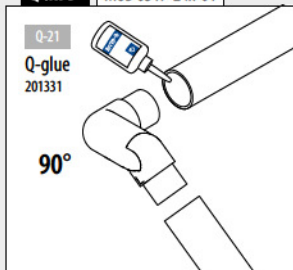



-90°
+90°

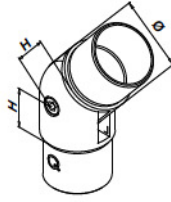

MOD 0302

V2A	304	Inox brossé			
INDOOR*			Ø	H	
SELL OUT	130302-233-12		33,7 x 2,0	22	2
	130302-242-12		42,4 x 2,0	27	2
	130302-248-12		48,3 x 2,0	30	2
V4A	316	Inox brossé			
OUTDOOR			Ø	H	
SELL OUT	140302-233-12		33,7 x 2,0	27	2
SELL OUT	140302-242-12		42,4 x 2,0	27	2
SELL OUT	140302-042-12		42,4 x 2,6	27	2
SELL OUT	140302-248-12		48,3 x 2,0	30	2
SELL OUT	140302-048-12		48,3 x 2,6	30	2



40 - 70°

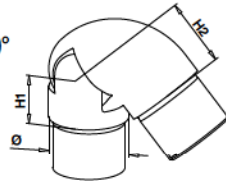

MOD 0319

V4A	316	Inox brossé				
OUTDOOR			Ø	H1	H2	
	140319-242-12		42,4 x 2,0	27	35	2
	140319-248-12		48,3 x 2,0	30	40	2



International Design Modèle Protection



0 - 70°

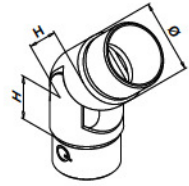

MOD 0312

V2A	304	Inox brossé			
INDOOR*			Ø	H	
	130312-233-12		33,7 x 2,0	22	2
SELL OUT	130312-142-12		42,4 x 1,5	30	2
	130312-242-12		42,4 x 2,0	27	2
SELL OUT	130312-042-12		42,4 x 2,6	27	2
	130312-248-12		48,3 x 2,0	30	2
	130312-048-12		48,3 x 2,6	30	2
V4A	316	Inox brossé			
OUTDOOR			Ø	H	
	140312-242-12		42,4 x 2,0	27	2
SELL OUT	140312-042-12		42,4 x 2,6	27	2
	140312-248-12		48,3 x 2,0	30	2
	140312-048-12		48,3 x 2,6	30	2
SELL OUT	140312-060-12		60,3 x 2,0	33	2
V4A	316	Poli miroir			
OUTDOOR			Ø	H	
	140312-242-10		42,4 x 2,0	27	2



International Design Modèle Protection

Q-INFO MOD 0312 / 0319

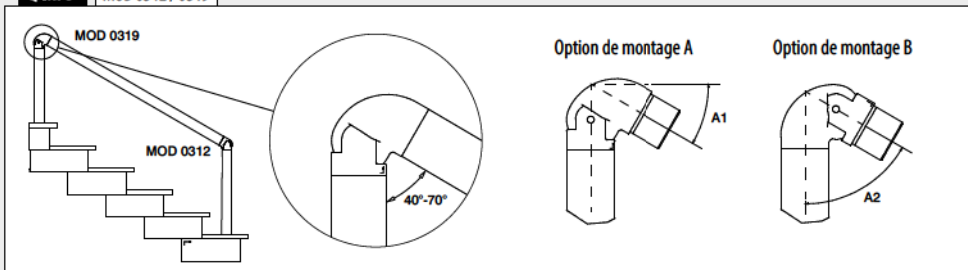

* Aussi pour l'extérieur dans des conditions physico-chimiques normales.



Seulement jusqu'à épuisement des stocks.

Embouts

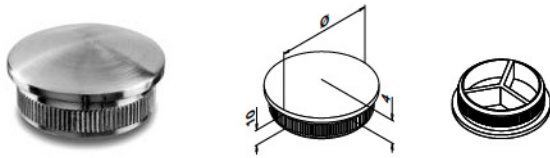

MOD 5729 - EASY HIT®

V2A	304	Inox brossé			
INDOOR*			Ø		
	135729-233-12		33,7 x 2,0		2
SELL OUT	135729-142-12		42,4 x 1,5		2
	135729-242-12		42,4 x 2,0		2
SELL OUT	135729-042-12		42,4 x 2,6		2
	135729-248-12		48,3 x 2,0		2
	135729-048-12		48,3 x 2,6		2
SELL OUT	135729-060-12		60,3 x 2,0		2
V4A	316	Inox brossé			
OUTDOOR			Ø		
	145729-233-12		33,7 x 2,0		2
	145729-242-12		42,4 x 2,0		2
SELL OUT	145729-042-12		42,4 x 2,6		2
	145729-248-12		48,3 x 2,0		2
	145729-048-12		48,3 x 2,6		2

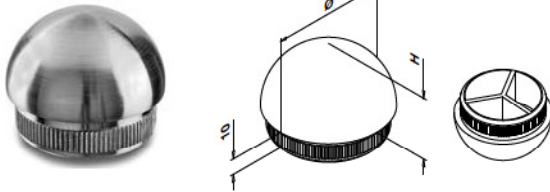

MOD 5730 - EASY HIT®

V2A	304	Inox brossé			
INDOOR*			Ø	H	
	135730-233-12		33,7 x 2,0	17	2
	135730-242-12		42,4 x 2,0	21	2
SELL OUT	135730-042-12		42,4 x 2,6	21	2
SELL OUT	135730-248-12		48,3 x 2,0	24	2
V4A	316	Inox brossé			
OUTDOOR			Ø	H	
	145730-242-12		42,4 x 2,0	21	2

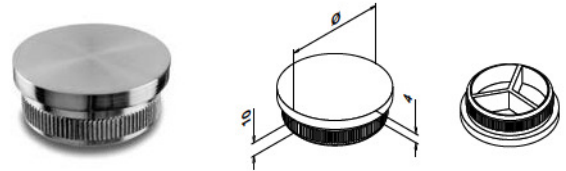

MOD 5732 - EASY HIT®

V2A	304	Inox brossé			
INDOOR*			Ø		
	135732-233-12		33,7 x 2,0		2
	135732-242-12		42,4 x 2,0		2
SELL OUT	135732-042-12		42,4 x 2,6		2
	135732-248-12		48,3 x 2,0		2
	135732-048-12		48,3 x 2,6		2
V4A	316	Inox brossé			
OUTDOOR			Ø		
SELL OUT	145732-233-12		33,7 x 2,0		2
	145732-242-12		42,4 x 2,0		2
SELL OUT	145732-042-12		42,4 x 2,6		2
	145732-248-12		48,3 x 2,0		2
	145732-048-12		48,3 x 2,6		2

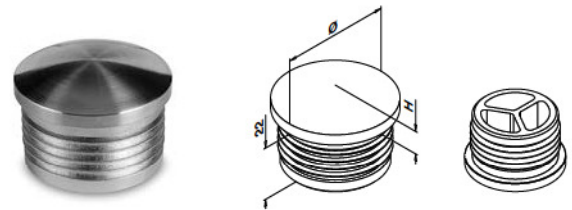

MOD 5729 - EASY HIT®

Plastique ABS		Aspect inox brossé			
INDOOR		Ø	H		
	155729-233	33,7 x 2,0	8		2
	155729-242	42,4 x 2,0	9		2
	155729-248	48,3 x 2,0	9		2



Q-INFO

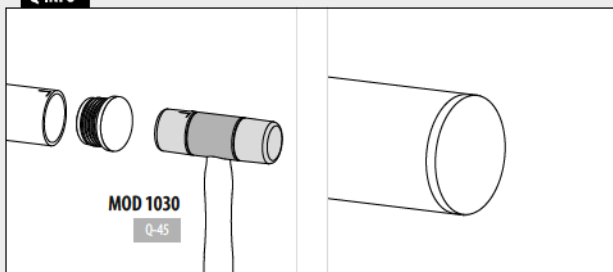

Retour mural

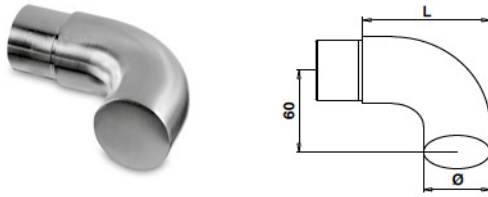

MOD 0739

V2A	304	Inox brossé		
	INDOOR*	Ø	L	
	130739-233-12	33,7 x 2,0	77	2
	130739-242-12	42,4 x 2,0	81	2
SELL OUT	130739-042-12	42,4 x 2,6	81	2
	130739-248-12	48,3 x 2,0	84	2
	130739-048-12	48,3 x 2,6	84	2
V4A	316	Inox brossé		
	OUTDOOR	Ø	L	
	140739-242-12	42,4 x 2,0	81	2
SELL OUT	140739-042-12	42,4 x 2,6	81	2
	140739-248-12	48,3 x 2,0	84	2
	140739-048-12	48,3 x 2,6	84	2



Emboutis croisés

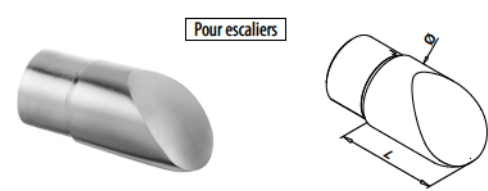

MOD 0738

V2A	304	Inox brossé		
	INDOOR*	Ø	L	
	130738-242-12	42,4 x 2,0	60	2
	130738-248-12	48,3 x 2,0	65	2
V4A	316	Inox brossé		
	OUTDOOR	Ø	L	
	140738-242-12	42,4 x 2,0	60	2



International Design Modèle Protection

* Aussi pour l'extérieur dans des conditions physico-chimiques normales.



Seulement jusqu'à épuisement des stocks.

Q-INFO MOD 0739

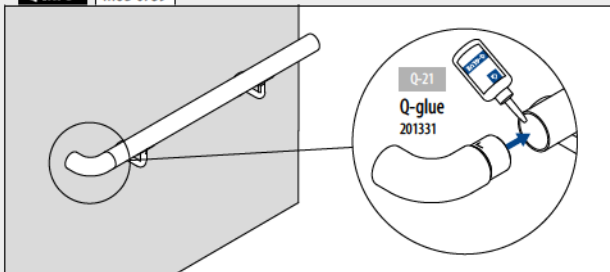

Q-INFO MOD 0738

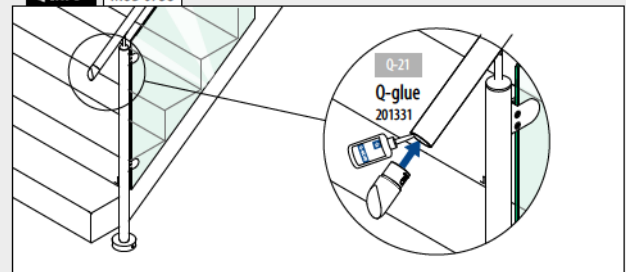

Embases murales pour tube

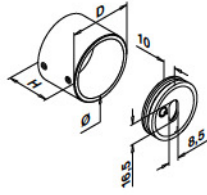

MOD 0504

V2A	304	Inox brossé						
INDOOR*			Ø	D	H			
130504-033-12	33,7	41	30	QS-55	374 / QS-21	376	2	
130504-042-12	42,4	50	35	QS-55	374 / QS-21	376	2	
130504-048-12	48,3	56	35	QS-55	374 / QS-21	376	2	

V4A	316	Inox brossé						
OUTDOOR			Ø	D	H			
140504-033-12	33,7	41	30	QS-55	374 / QS-22	376	2	
140504-042-12	42,4	50	35	QS-55	374 / QS-22	376	2	
140504-048-12	48,3	56	35	QS-55	374 / QS-22	376	2	

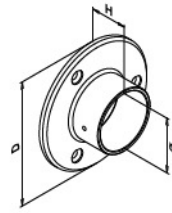

MOD 0505

V2A	304	Inox brossé						
INDOOR*			Ø	D	H			
130505-033-12	33,7	85	30	QS-7	375	2		
130505-042-12	42,4	95	30	QS-7	375	2		
130505-048-12	48,3	100	35	QS-7	375	2		
SELL OUT	130505-060-12	60,3	115	40	QS-7	375	2	

V2A	304	Poli miroir						
INDOOR*			Ø	D	H			
SELL OUT	130505-042-10	42,4	95	30	QS-7	375	2	

V4A	316	Inox brossé						
OUTDOOR			Ø	D	H			
140505-042-12	42,4	95	30	QS-50	375	2		
140505-048-12	48,3	100	35	QS-50	375	2		

V4A	316	Poli miroir						
OUTDOOR			Ø	D	H			
140505-042-10	42,4	95	30	QS-50	375	2		



Embases murales pour tube

Orientables



0 - 50°

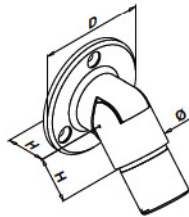

MOD 0506

V2A	304	Inox brossé						
INDOOR*			Ø	D	H			
SELL OUT	130506-033-12	33,7 x 2,0	70	26	QS-7	375	2	
SELL OUT	130506-042-12	42,4 x 2,0	75	30	QS-7	375	2	
SELL OUT	130506-048-12	48,3 x 2,0	80	33	QS-7	375	2	



International Design Modèle Protection

Q-INFO MOD 0504

